

Instalation manual

ARSAL: WIT 2W2S

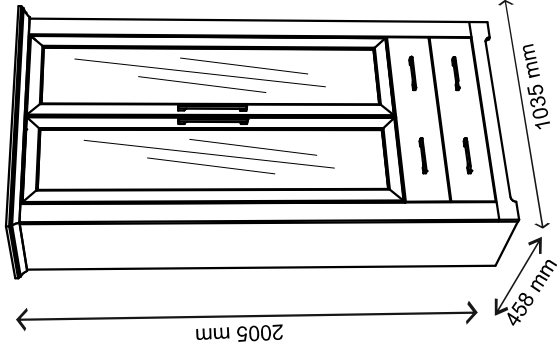

Element symbol	Dimensions	Code	Package
1	1984 404	1 WIT_WYS_2W2S.003	2/2
2	1984 404	1 WIT_WYS_2W2S.004	2/2
3	803 390	2 WIT_WYS_2W2S.006	3/3
4	803 390	1 WIT_WYS_2W2S.007	3/3
5	1904 80	2 WIT_WYS_2W2S.008	1/1
6	796 180	1 WIT_WYS_2W2S.009	3/3
7	745 130	2 WIT_WYS_2W2S.010	3/3
8	961 80	1 WIT_WYS_2W2S.011	3/3
9	803 60	1 WIT_WYS_2W2S.012	3/3
10	350 130	2 WIT_WYS_2W2S.013	3/3
11	350 130	2 WIT_WYS_2W2S.014	3/3
12	60 334	2 WIT_WYS_2W2S.015	3/3
13	1904 401	1 WIT_WYS_2W2S.016	1/1
14	1904 401	1 WIT_WYS_2W2S.017	1/1
15	1035 458	1 WIT_WYS_2W2S.018	3/3
16	803 401	1 WIT_WYS_2W2S.019	3/3
17	796 180	1 WIT_WYS_2W2S.020	3/3
18	1929 472	3 2 WIT_WYS_2W2S.001	1/1
19	763 352	3 2 WIT_WYS_2W2S.002	2/2
20	927 401	16 1 WIT_WYS_2W2S.005	3/3
21	1502 396	16 2 WIT_WYS_2W2S.W1	4/4

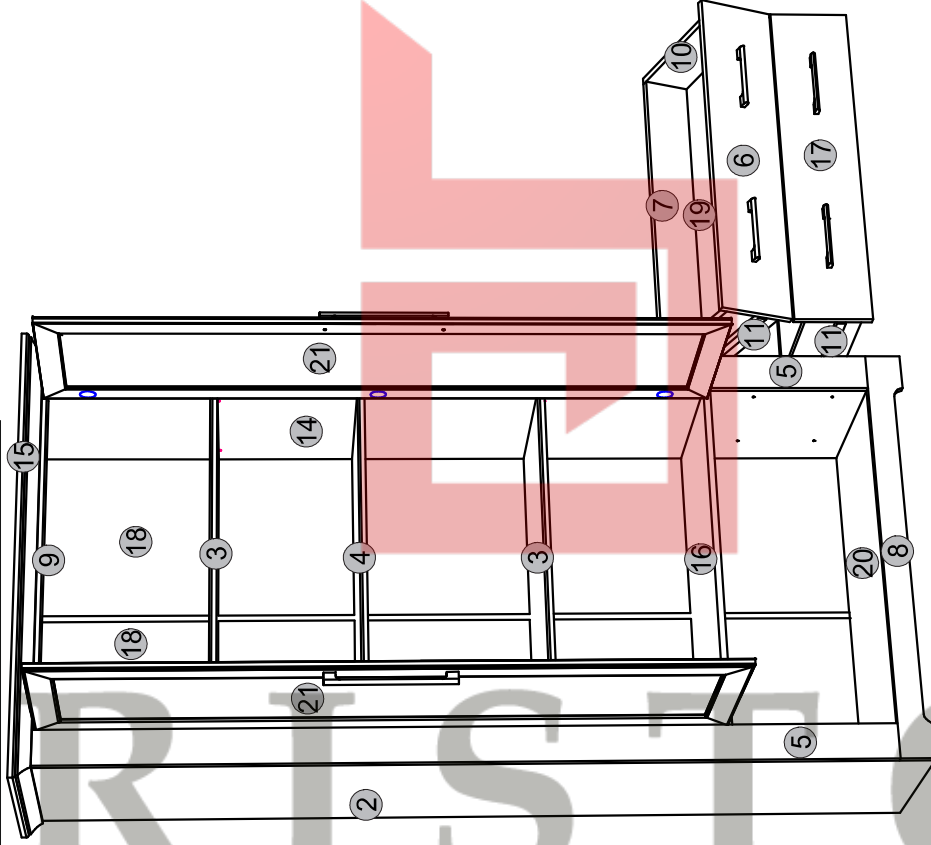
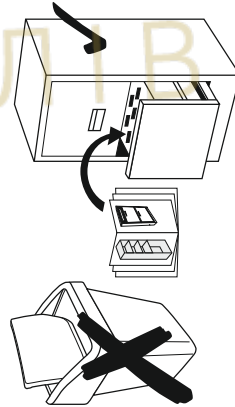
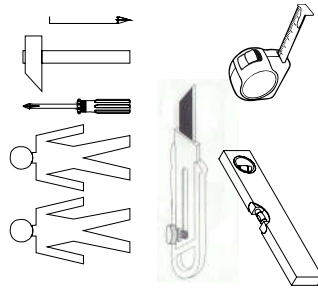
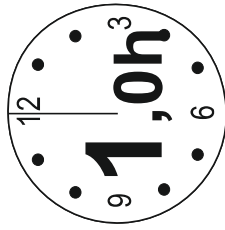
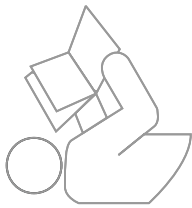
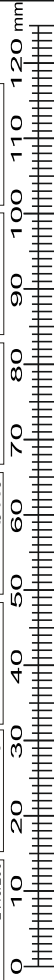
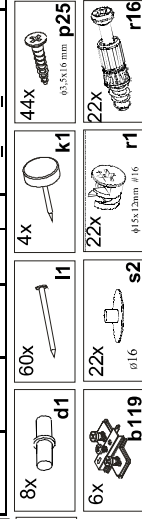
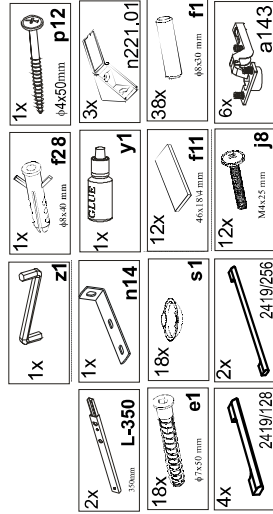

1

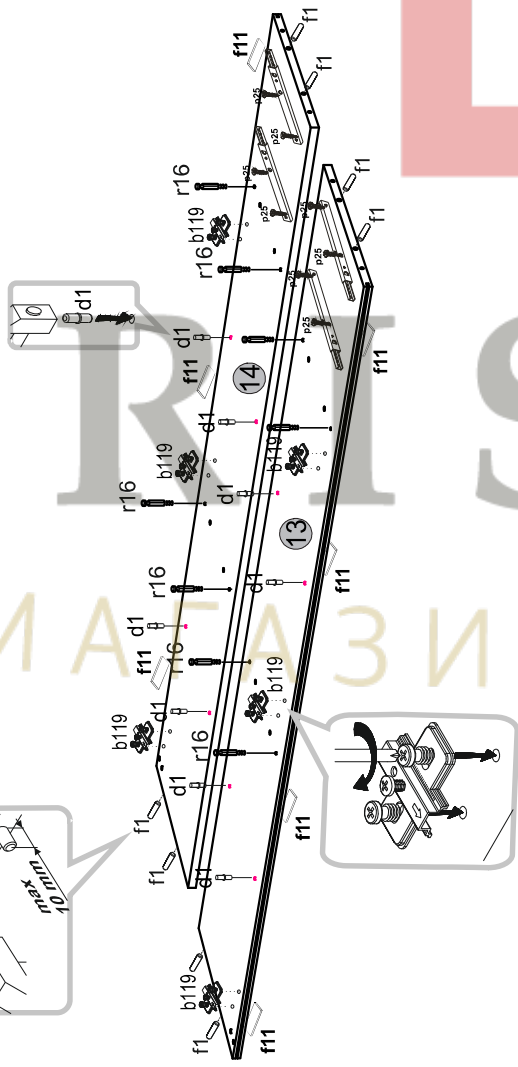
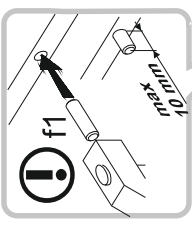

3

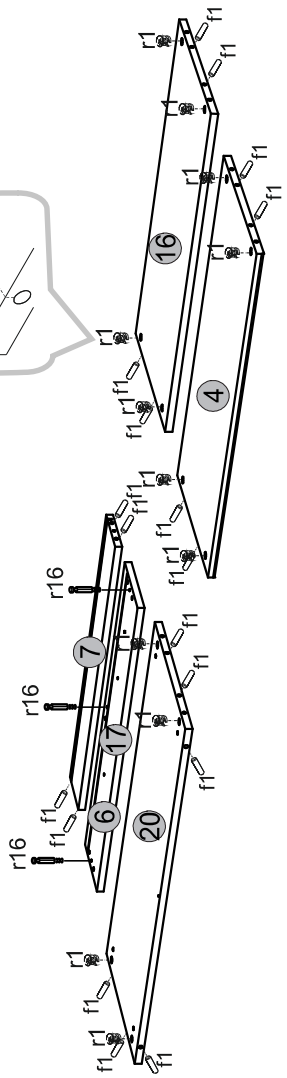
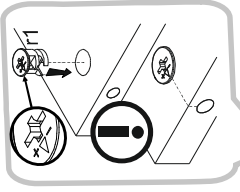

2

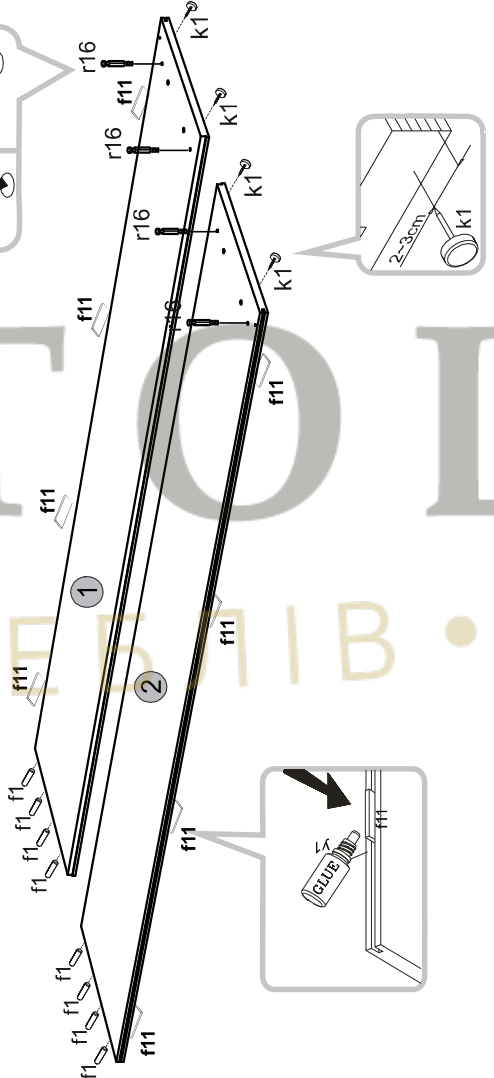
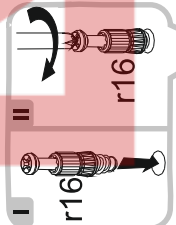
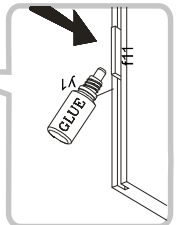

4

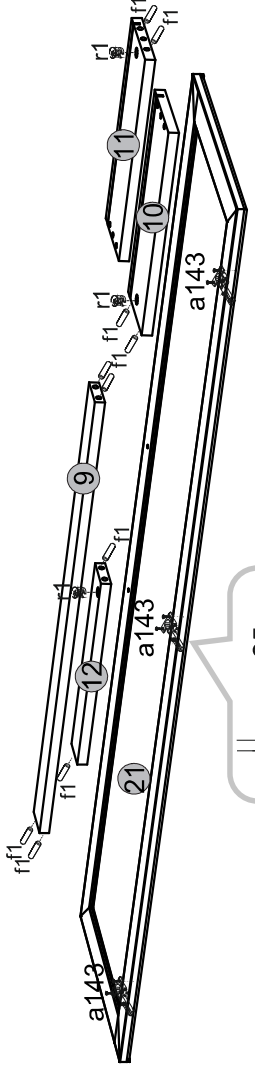
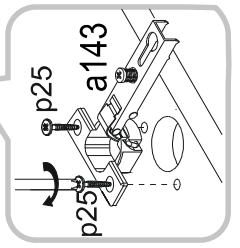

7

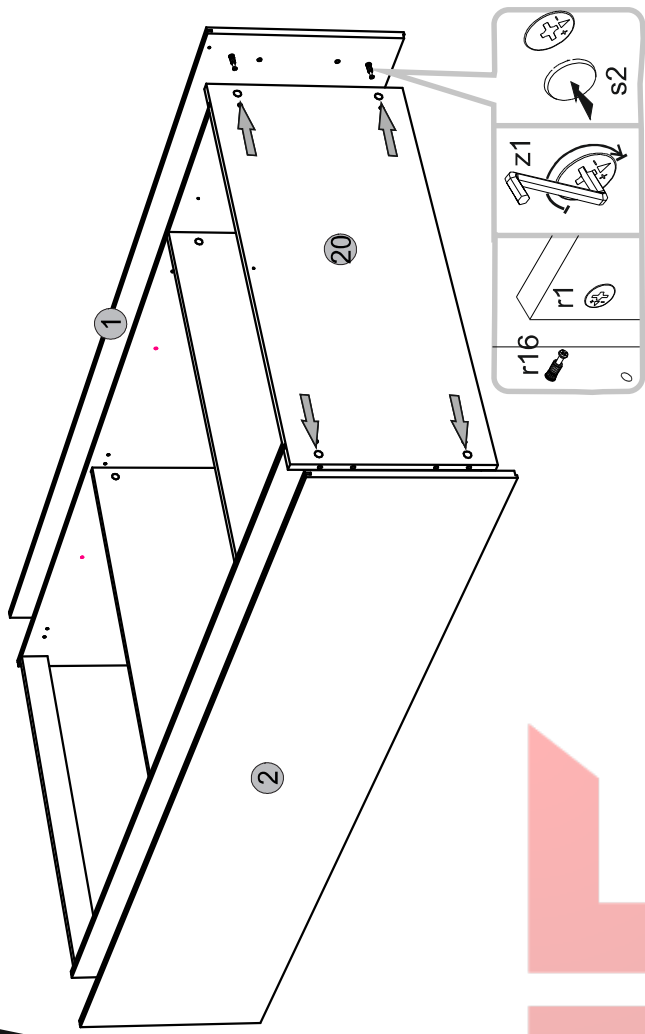

8

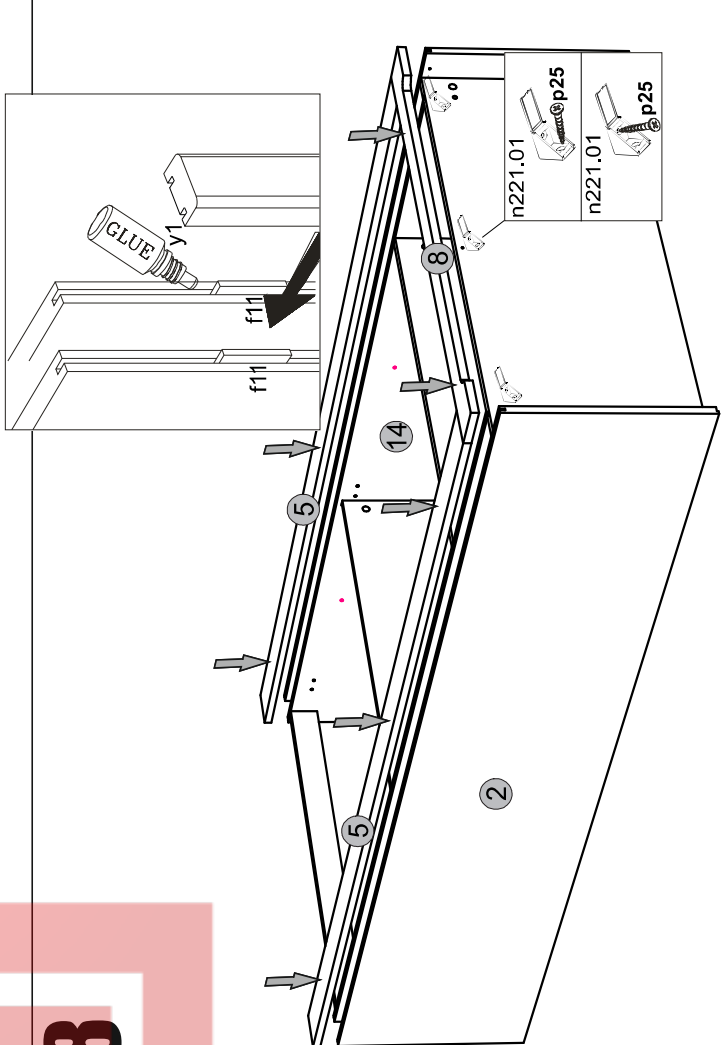

5

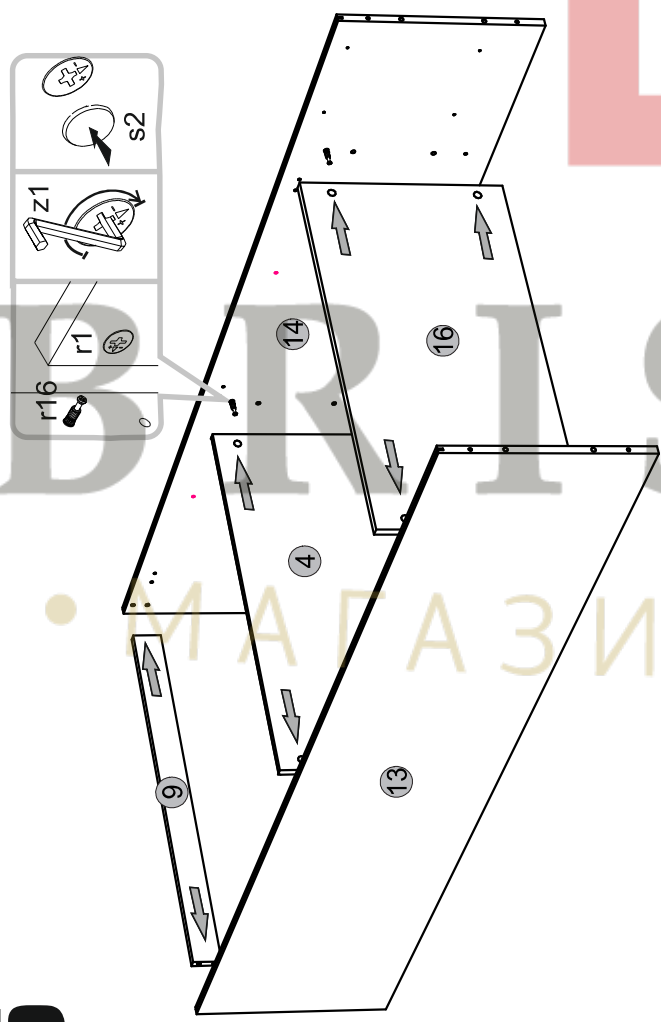

6

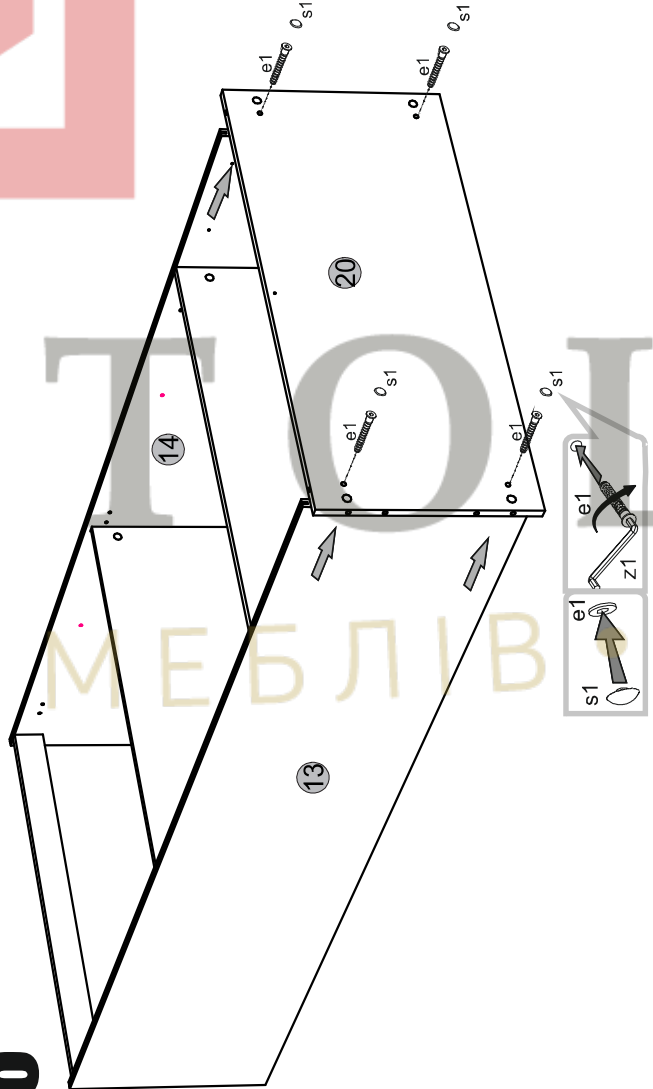

12

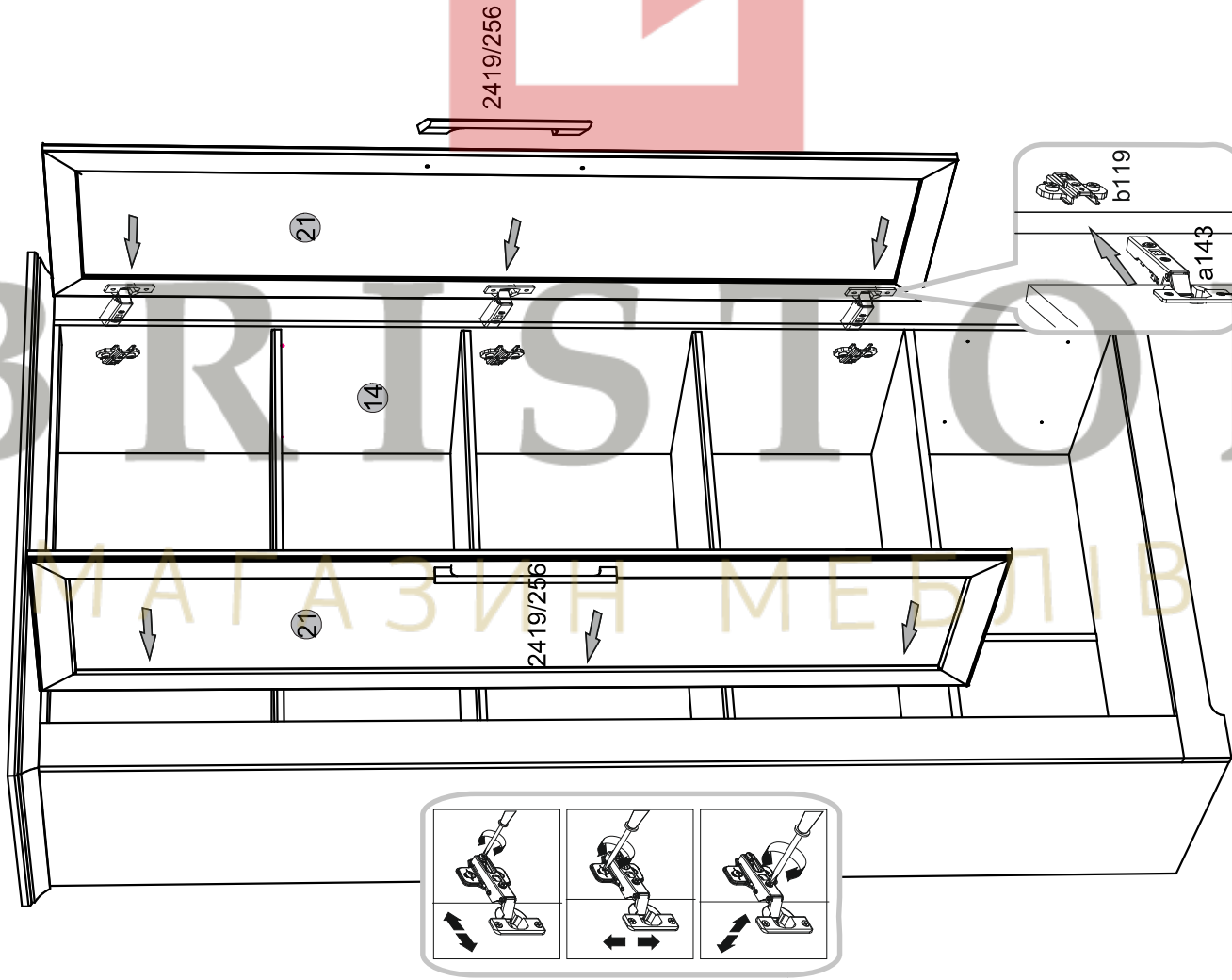

13

