

A	B	C		D					
1	BK1-013	1650	360	1/2	8	BK1-121	2000	250	2/2
2	BK1-401	1650	873	1/2	9	BK1-122	1603	200	2/2
3	BK1-402	1650	371	1/2	10	BK1-212	1695	61	2/2
4	BK1-117	873	60	2/2	11	BK1-213	1695	61	2/2
5	BK1-118	873	60	2/2	12	BK1-214	120	61	2/2
6	BK1-119	371	60	2/2	13	BK1-403	339	60	2/2
7	BK1-120	371	60	2/2	14	BK1-404	1650	30	2/2

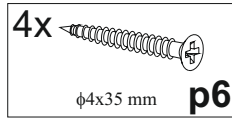

# 1

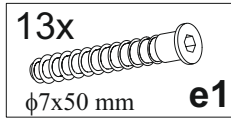
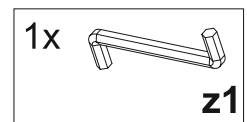
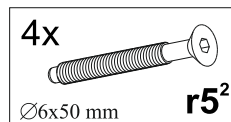
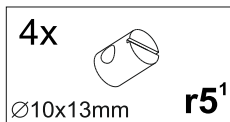
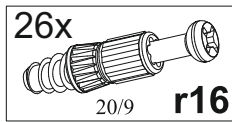
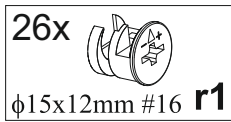
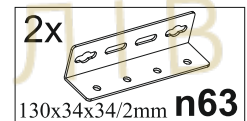
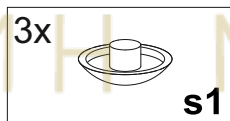
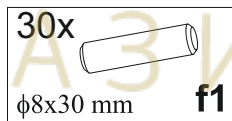
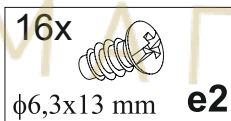
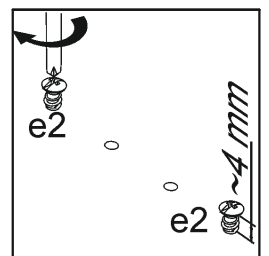
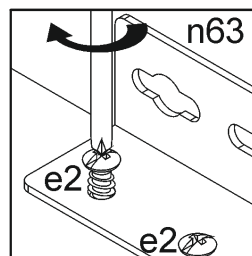
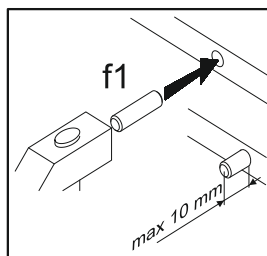
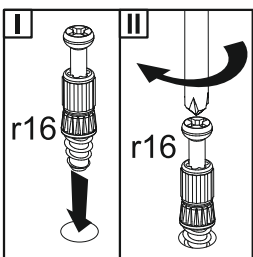
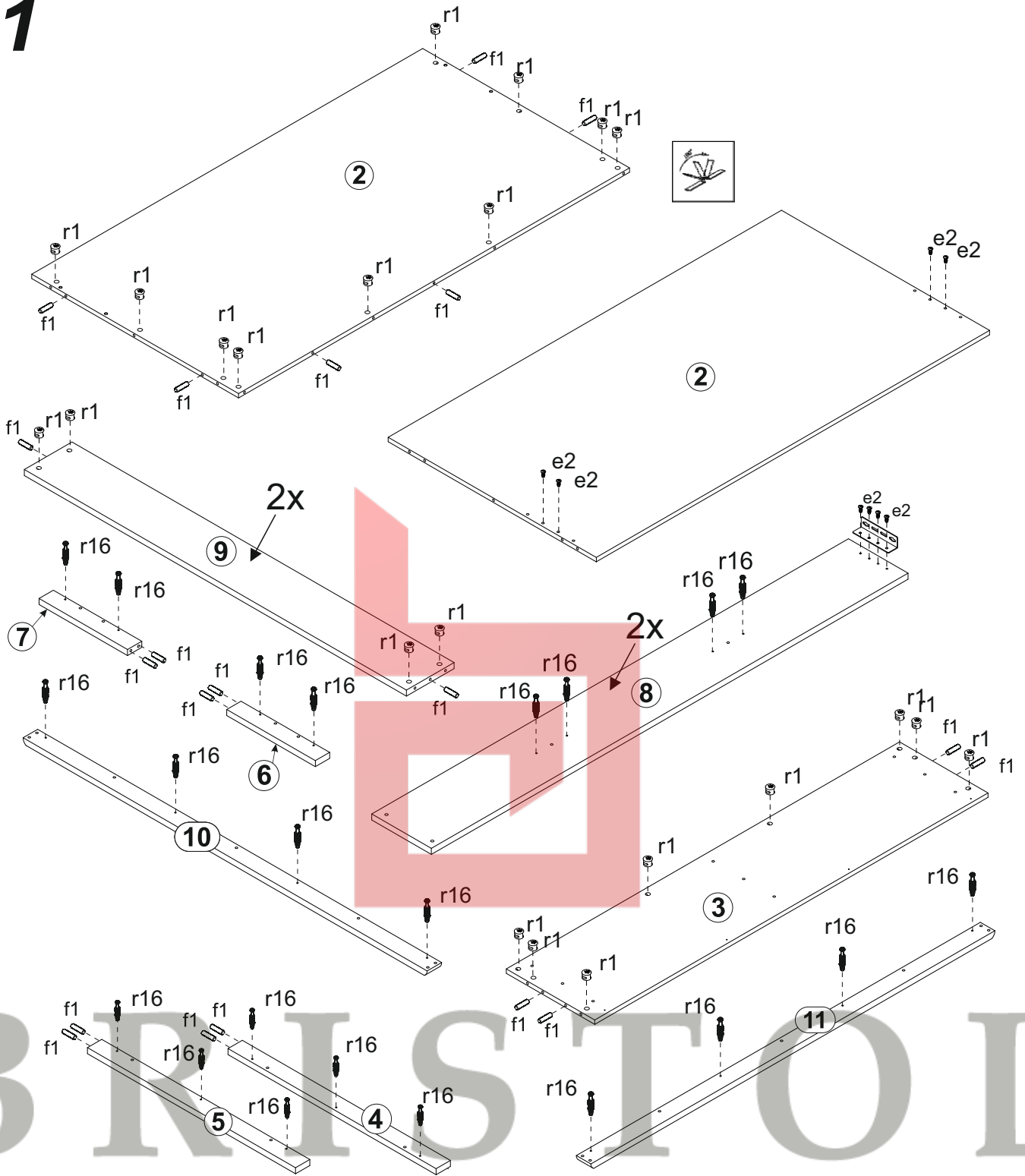

# 2

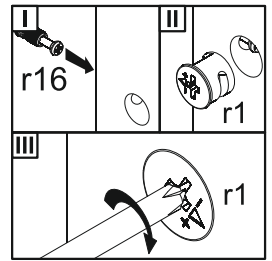
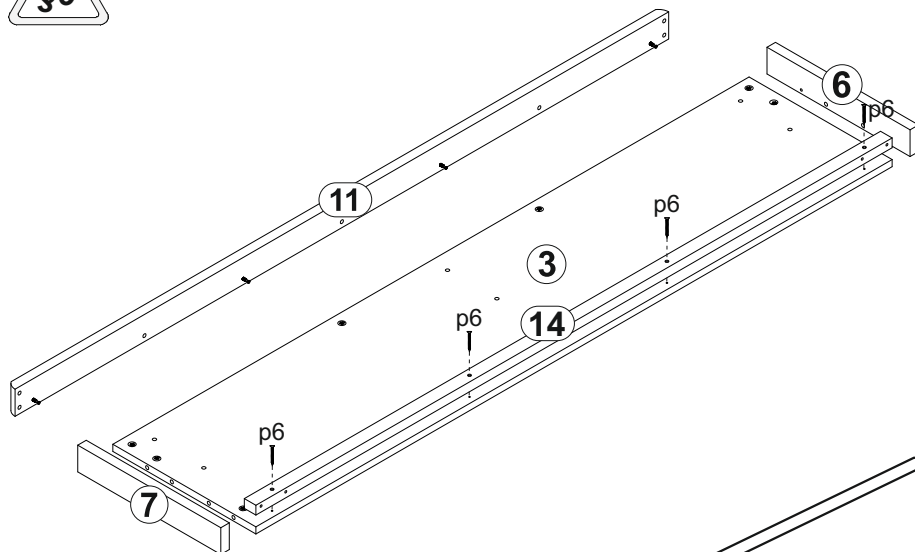

# 3

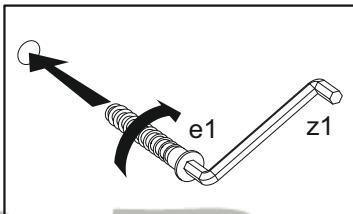
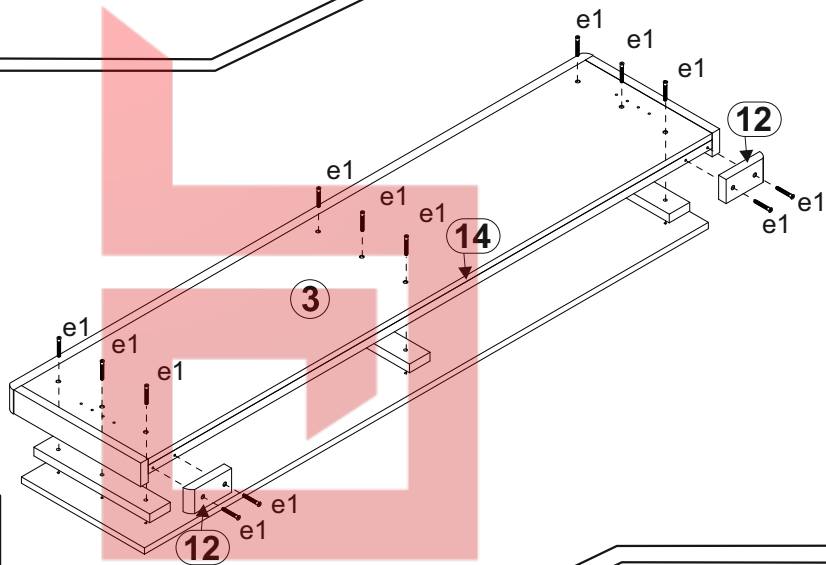

# 4

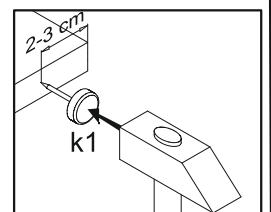
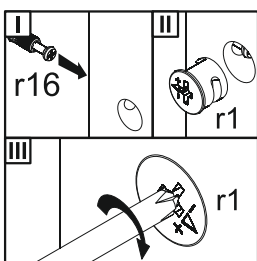
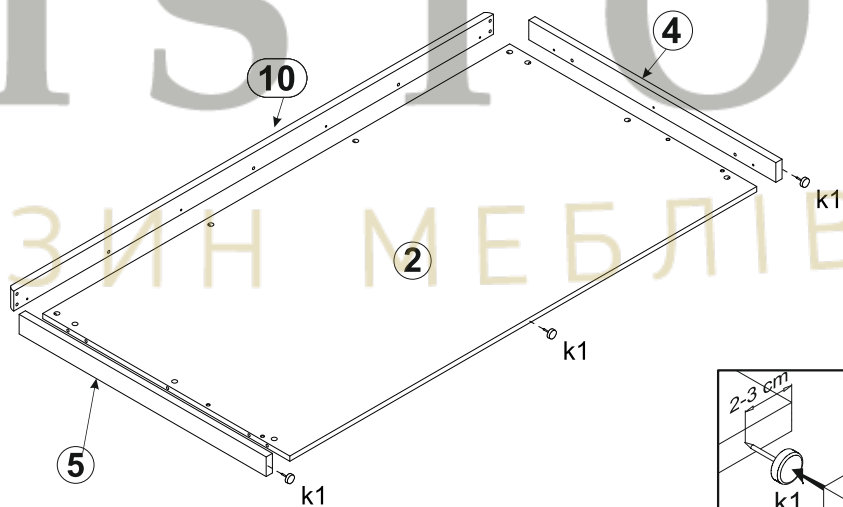

# 5

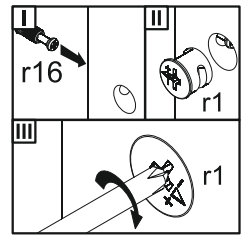
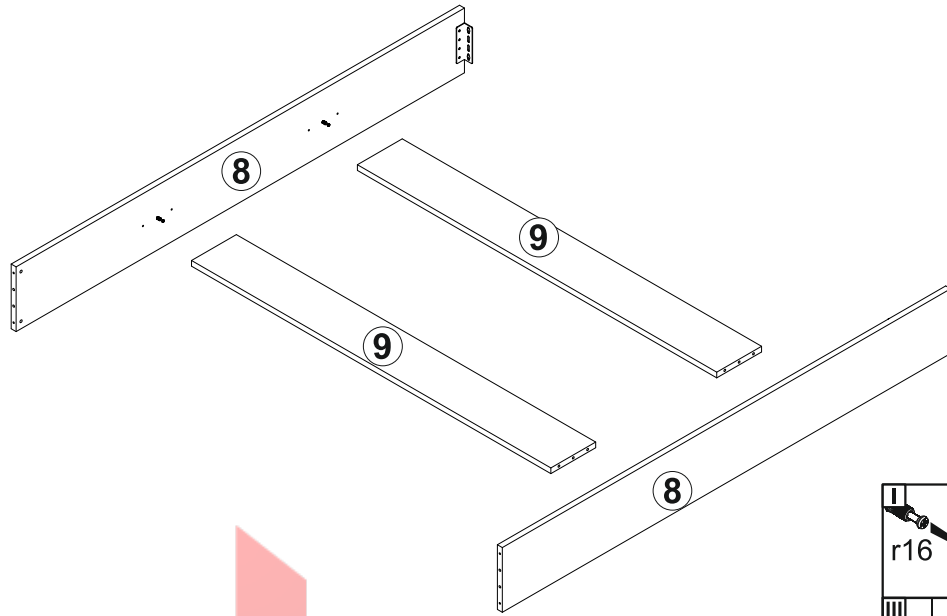

# 6

