

| A | B | C | | D |
|---|-----------|------|-----|-----|
| 1 | S350-112 | 316 | 300 | 1/2 |
| 2 | S350-113 | 346 | 120 | 1/2 |
| 3 | S350-315 | 1416 | 300 | 1/2 |
| 4 | S350-316 | 1416 | 300 | 1/2 |
| 5 | S350-411 | 1446 | 346 | 1/2 |
| 6 | S350-5003 | 300 | 51 | 2/2 |

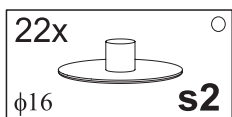

1 

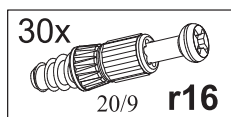
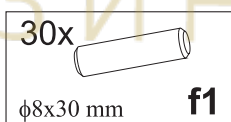
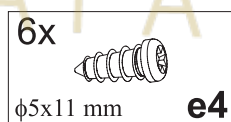
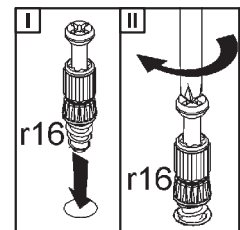
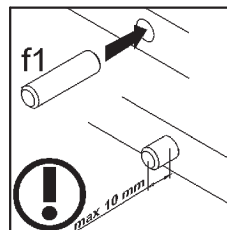
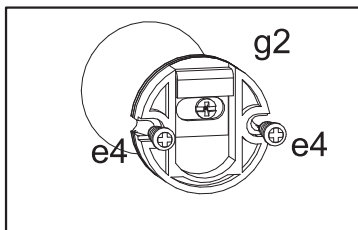
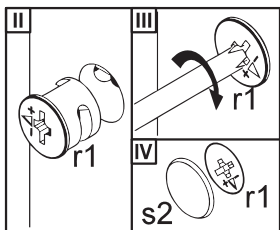
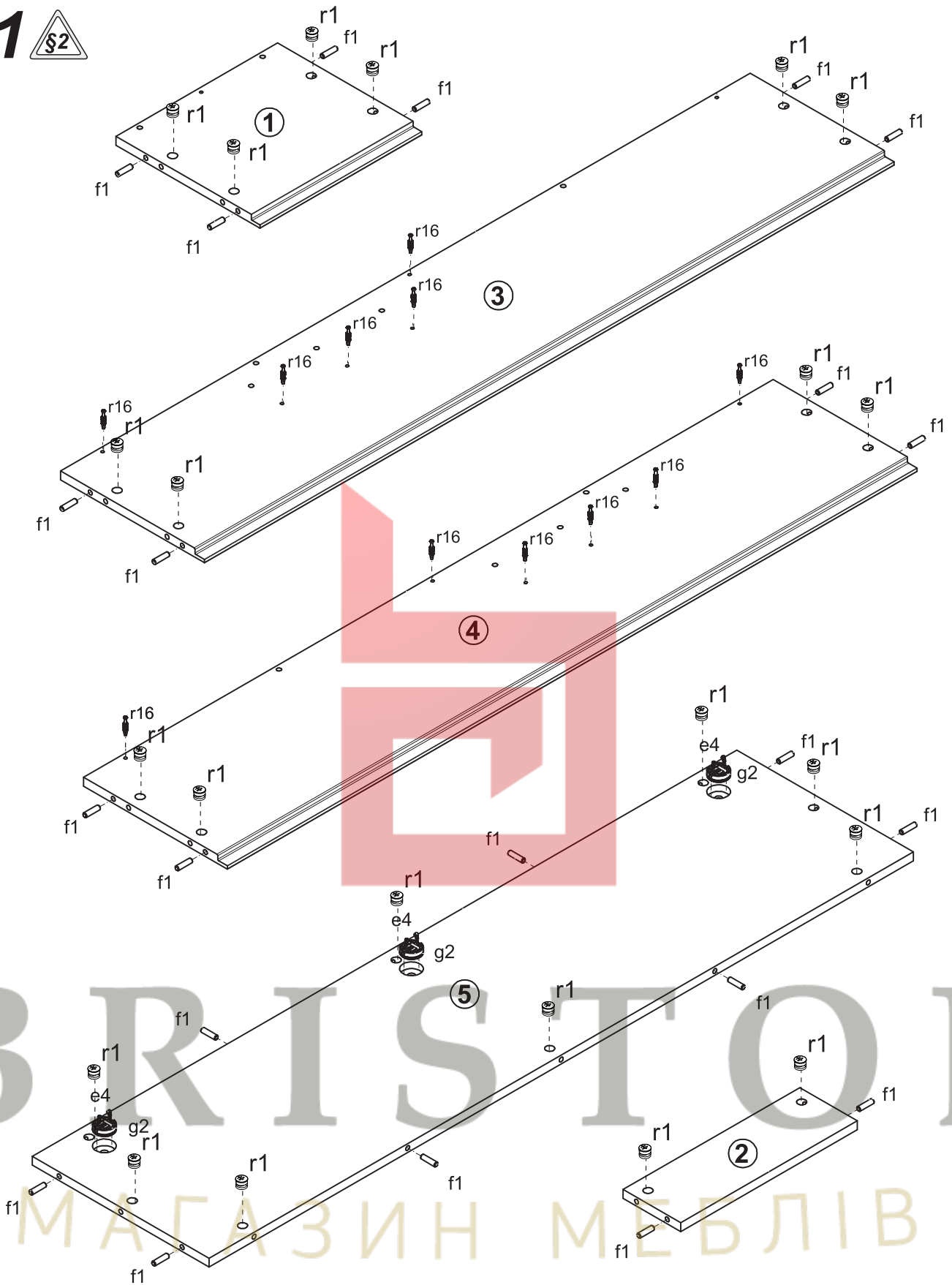

2 

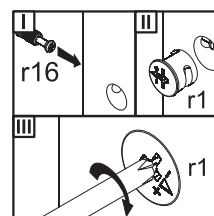
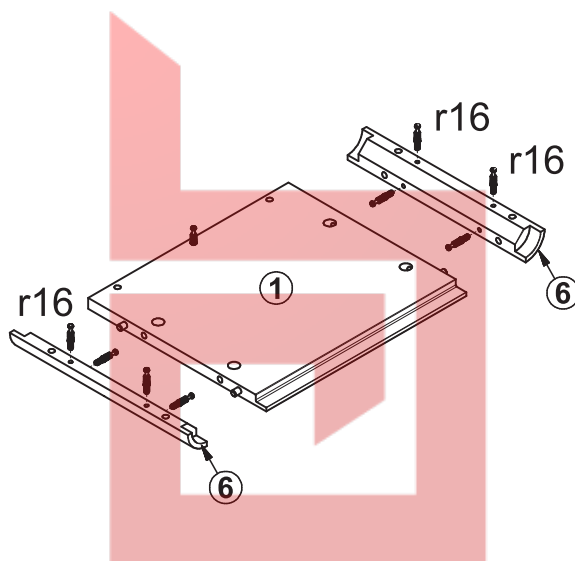
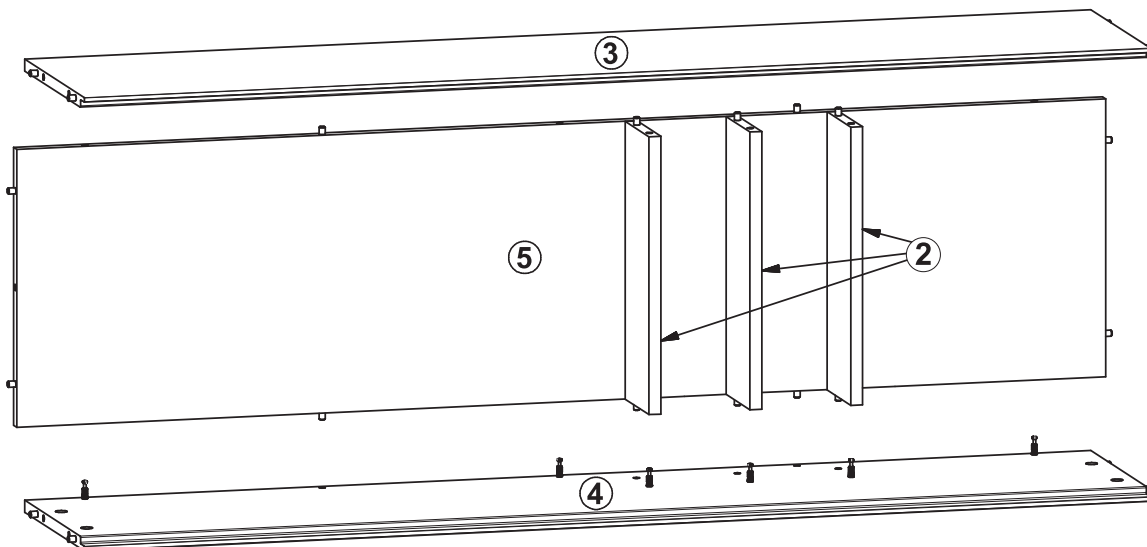

3

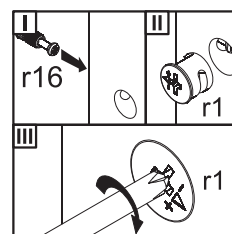
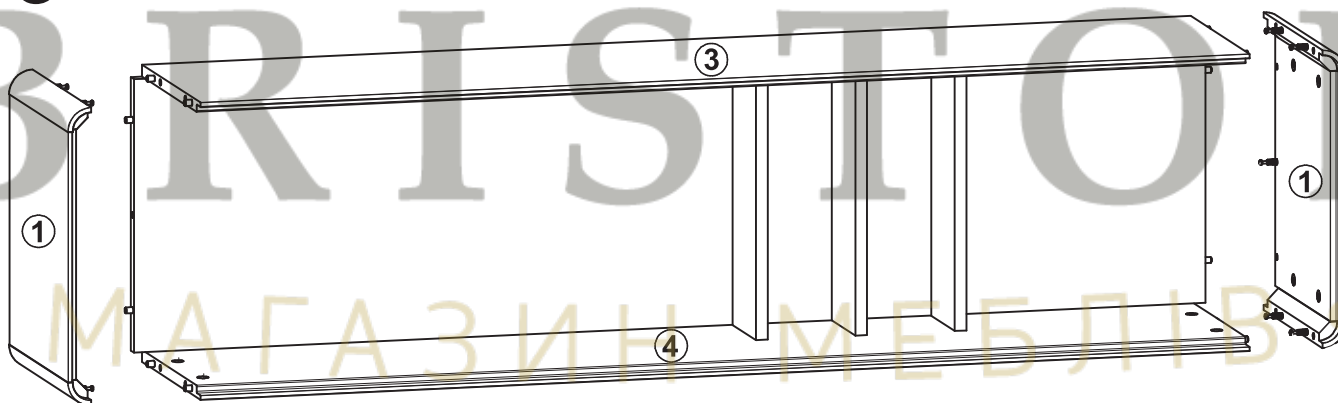

4

