

A	B	C		D					
1	KN1-001	396	180	3/3	11	KN1-302	1242	417	2/3
2	KN1-002	564	396	3/3	12	KN1-303	401	394	2/3
3	KN1-003	564	396	3/3	13	KN1-551	350	140	1/3
4	KN1-101	857	440	1/3	14	KN1-552	350	140	1/3
5	KN1-102	857	440	1/3	15	KN1-553	344	140	1/3
6	KN1-103	570	415	1/3	16	KN1-554	344	140	1/3
7	KN1-104	186	415	1/3	17	KN1-901	797	418	1/3
8	KN1-105	570	415	1/3	18	KN1-902	797	418	1/3
9	KN1-201	1336	450	2/3	19	KN1-903	797	418	1/3
10	KN1-301	1242	417	2/3	20	KN1-904	359	331	1/3

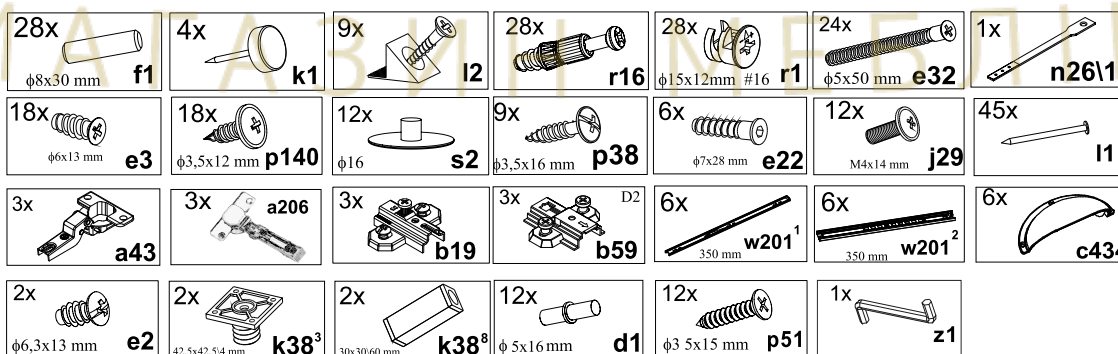

1

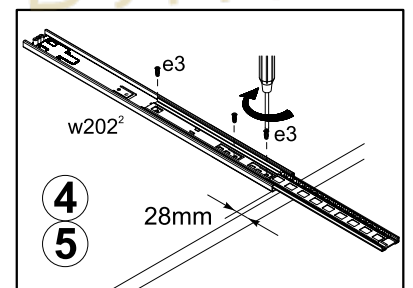
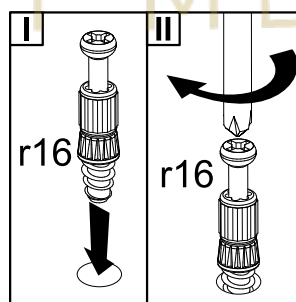
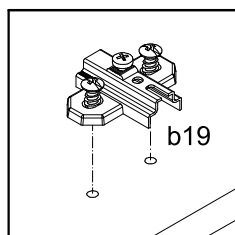
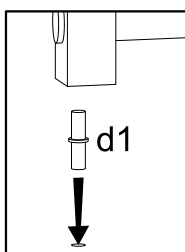
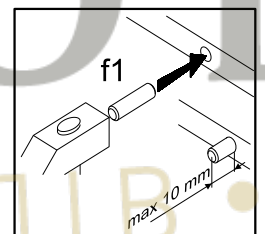
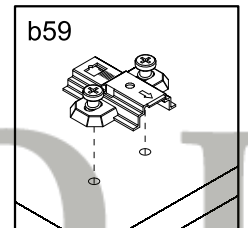
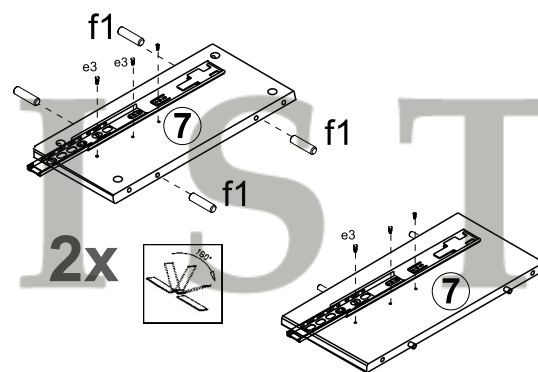
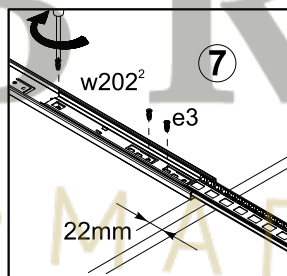
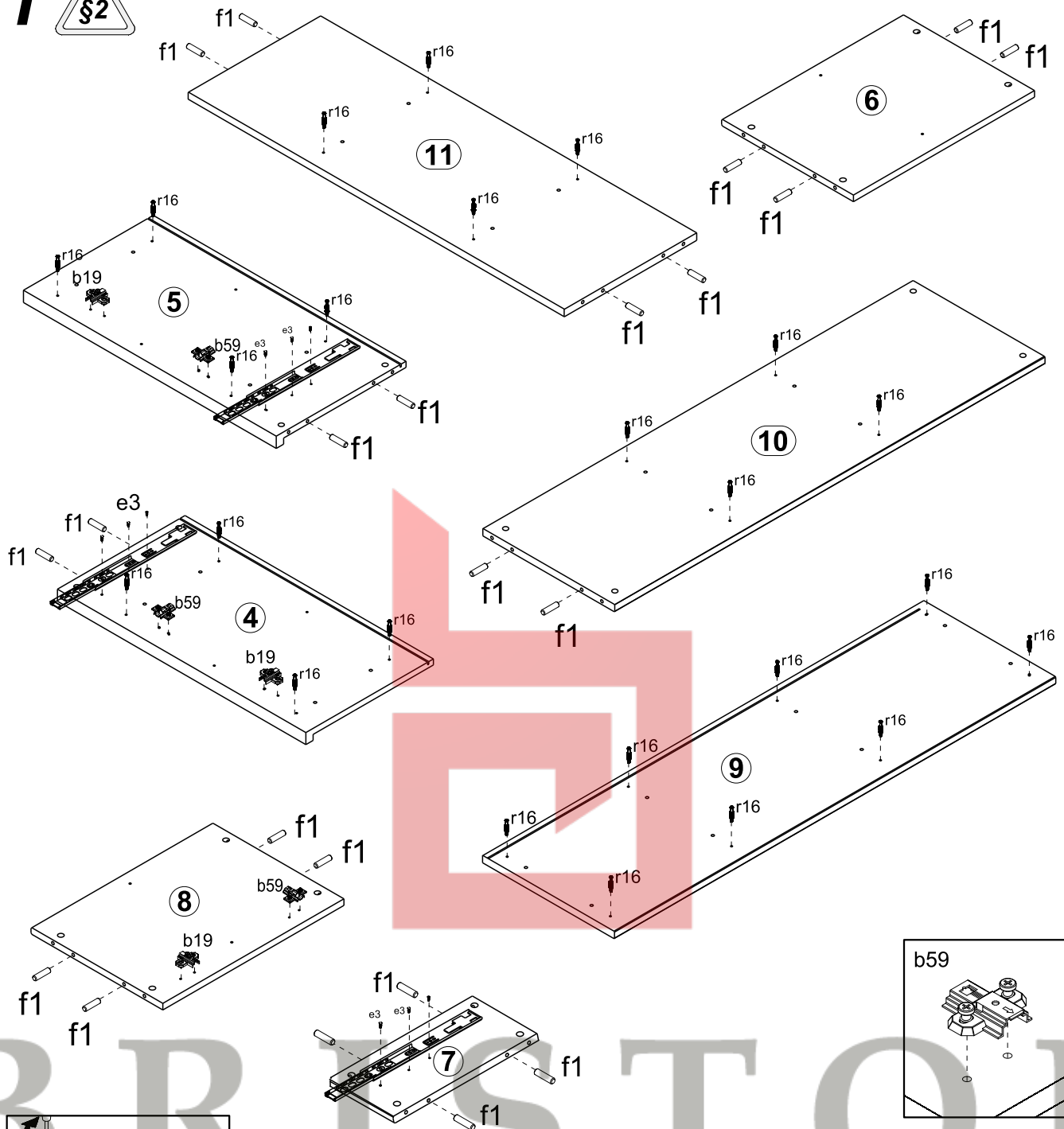

# 2

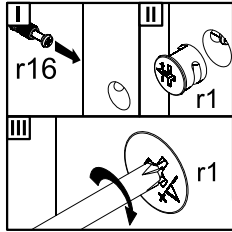
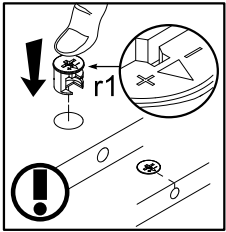
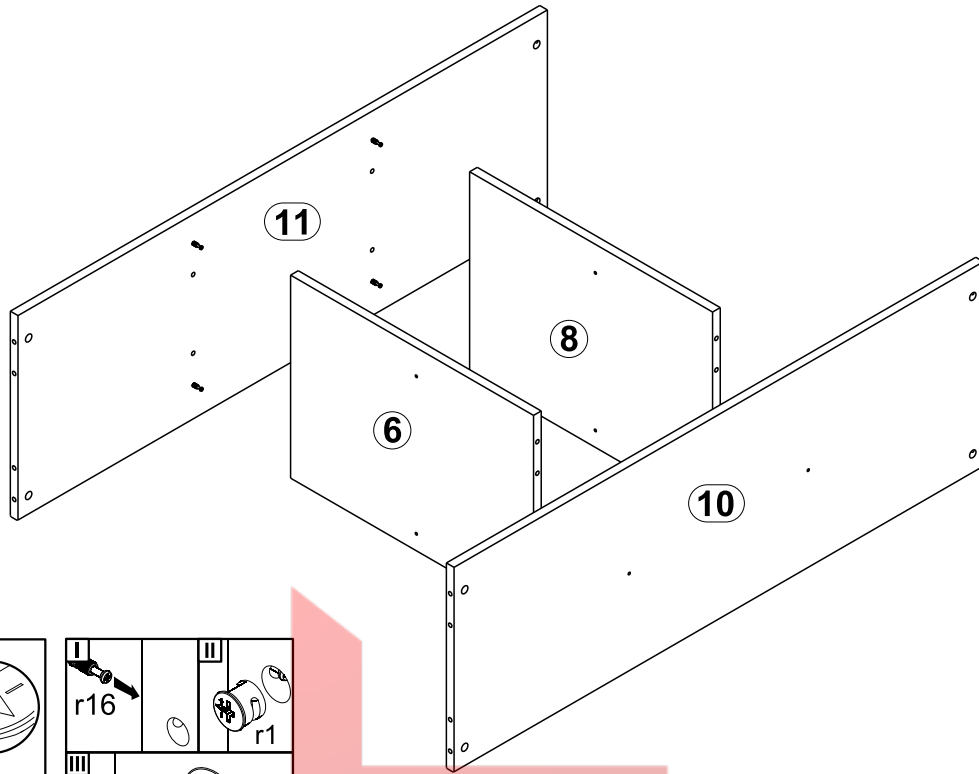

# 3

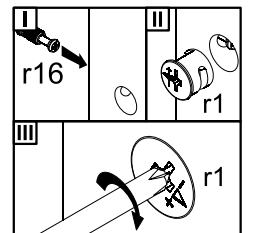
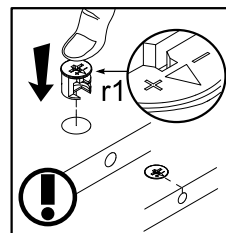
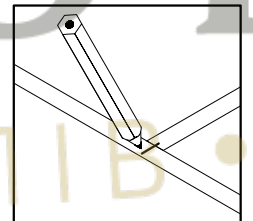
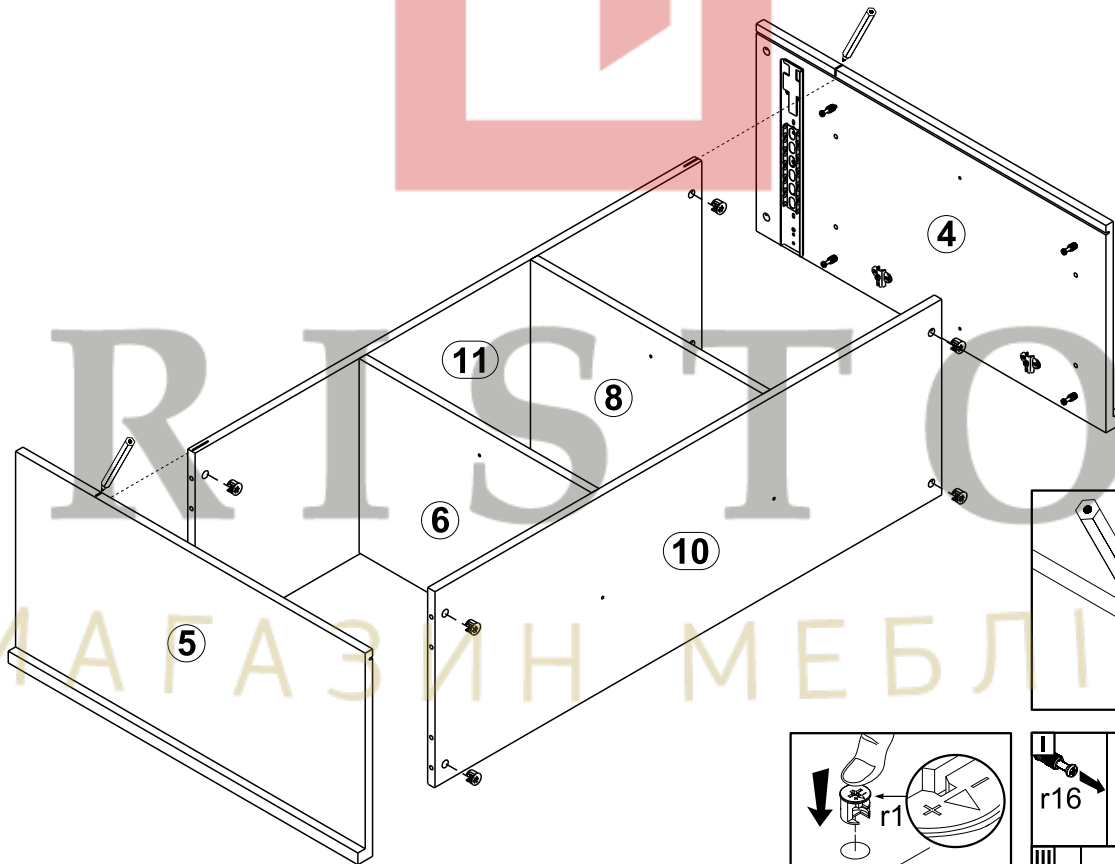

4

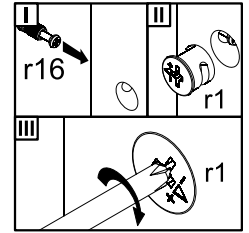
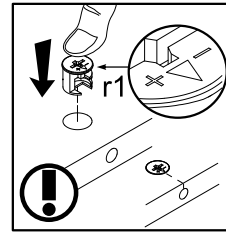
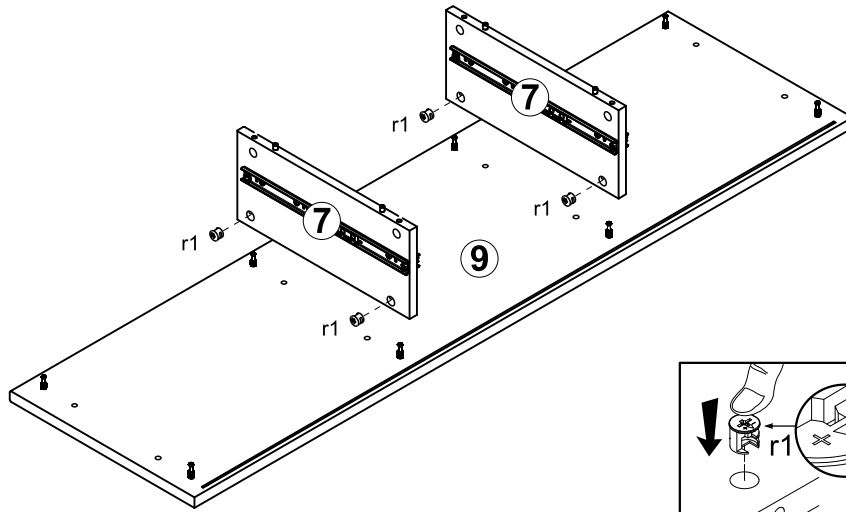

5

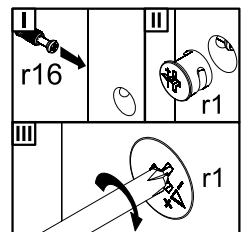
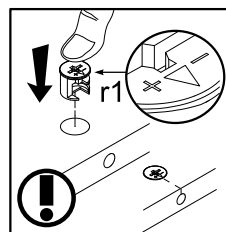
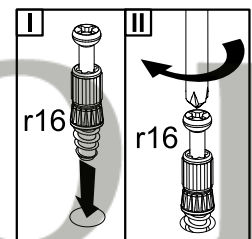
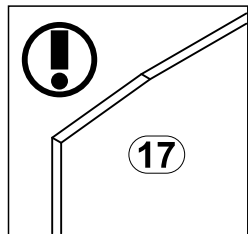
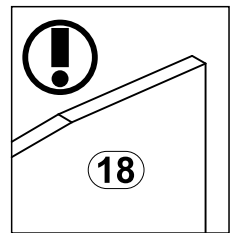
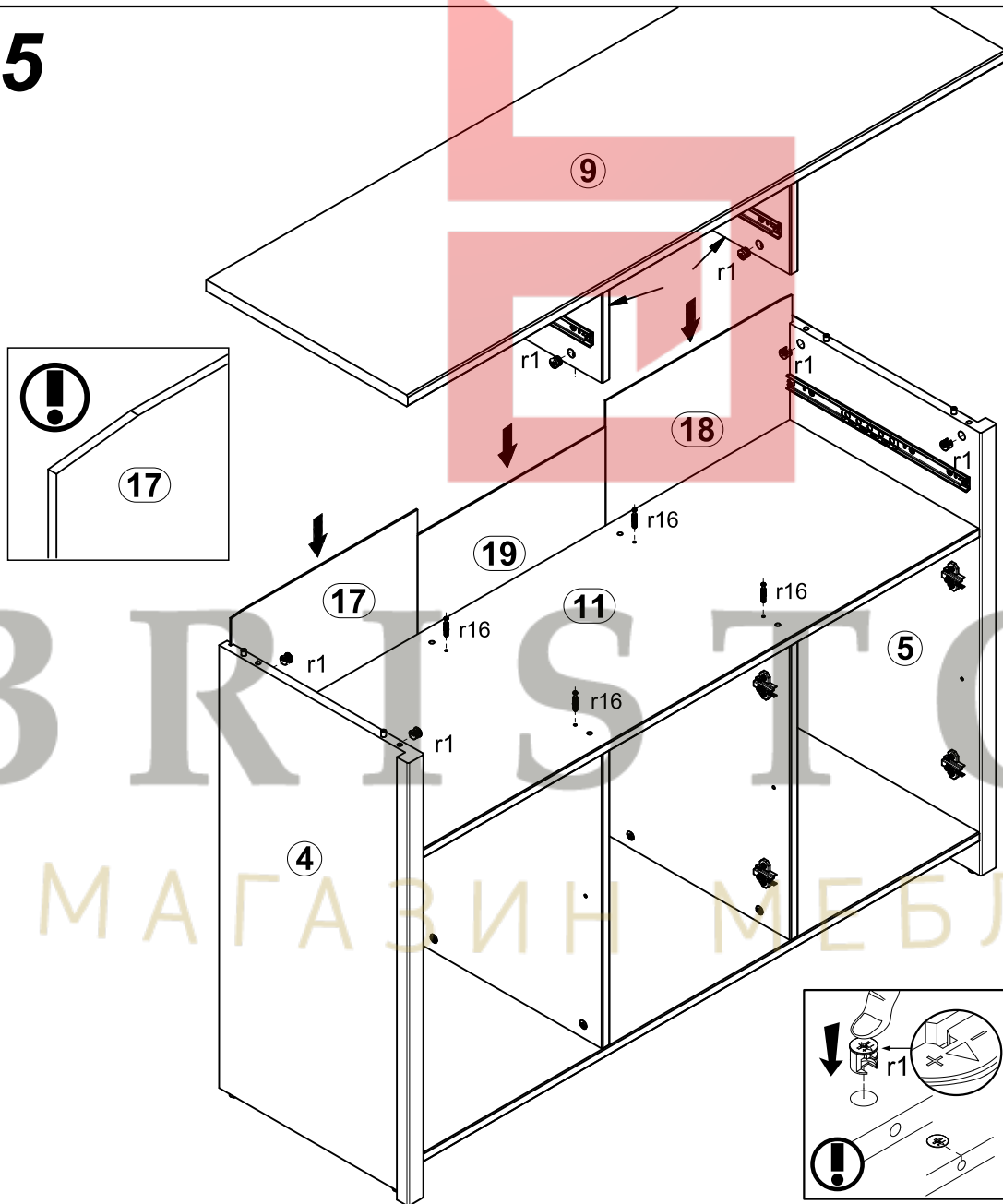

# 6

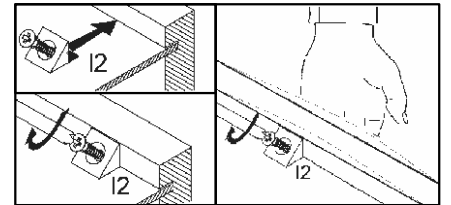
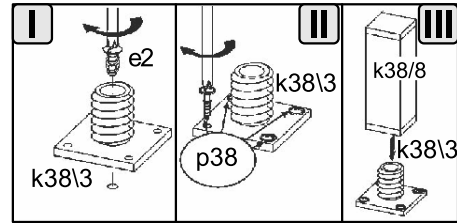
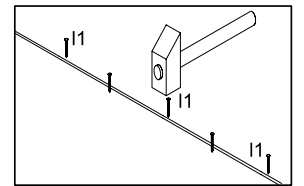
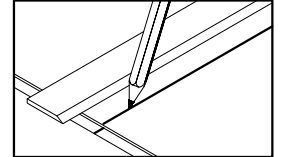
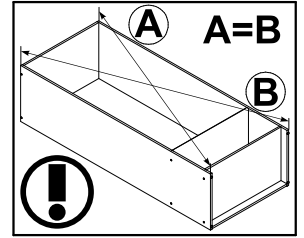
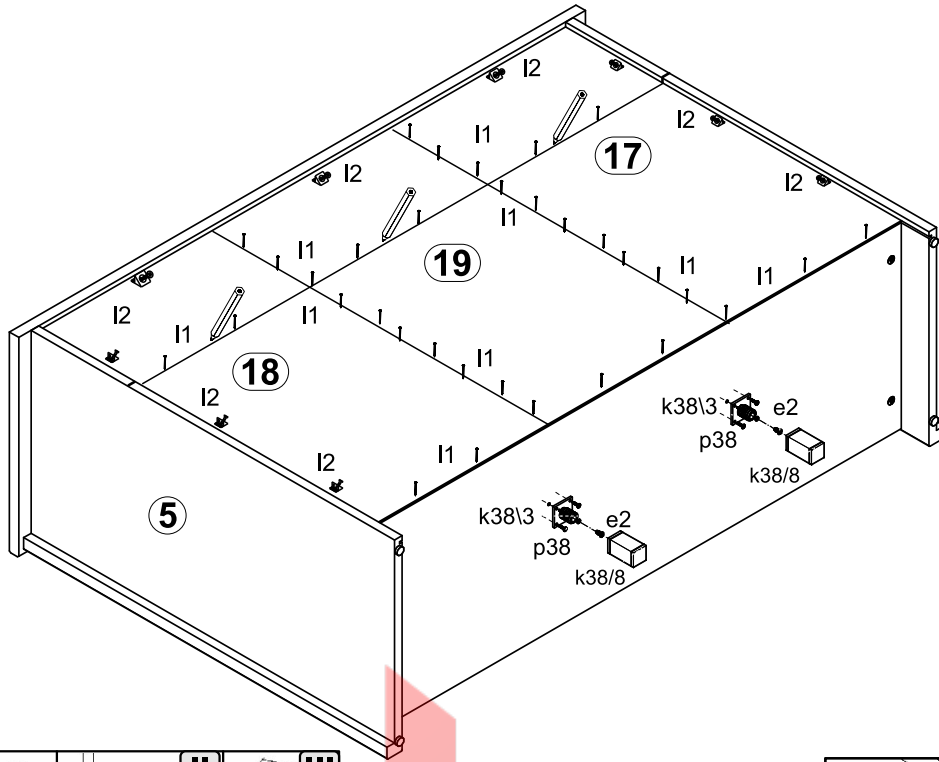

# 7

