

A

ZLATA

REG1W1D

| A | B | C | D |
|----|------------|------|---------|
| 1 | S383-00010 | 606 | 555 1/2 |
| 2 | S383-00011 | 1284 | 555 1/2 |
| 3 | S383-11007 | 1904 | 385 1/2 |
| 4 | S383-11008 | 1904 | 385 1/2 |
| 5 | S383-22007 | 560 | 403 2/2 |
| 6 | S383-22008 | 560 | 403 2/2 |
| 7 | S383-33002 | 527 | 380 2/2 |
| 8 | S383-33008 | 526 | 380 2/2 |
| 9 | S383-55002 | 525 | 350 2/2 |
| 10 | S383-99534 | 1931 | 553 1/2 |

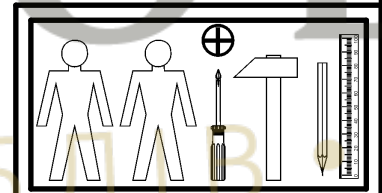
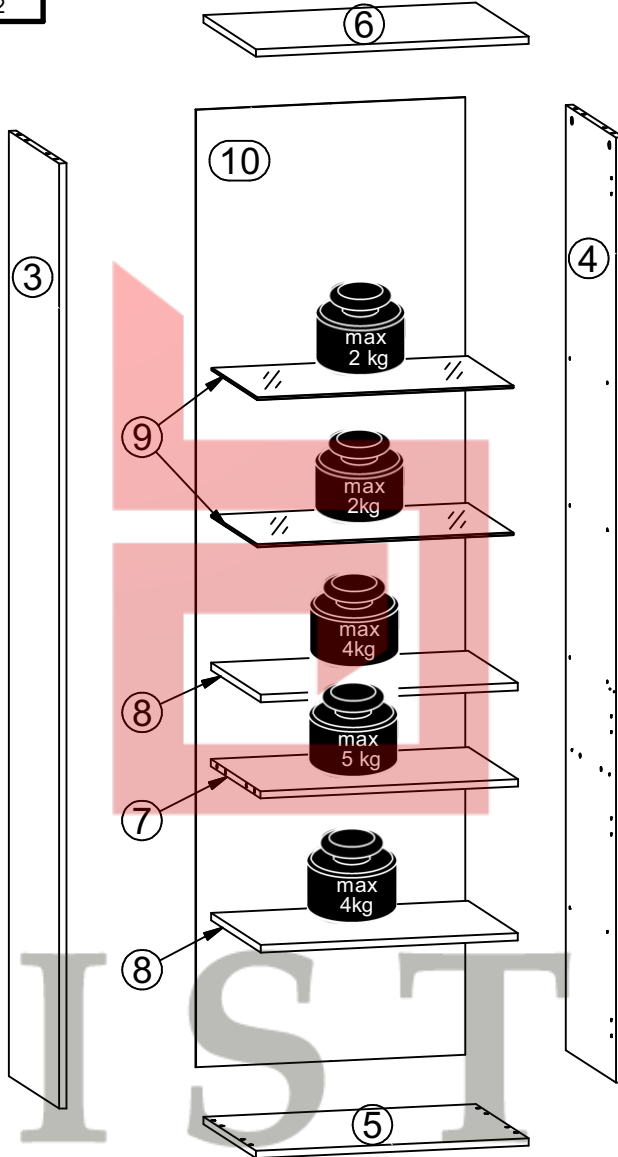
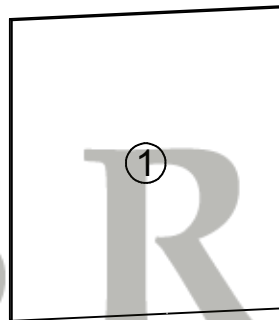
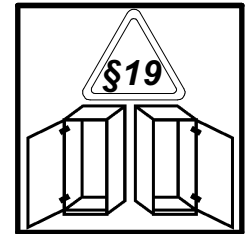
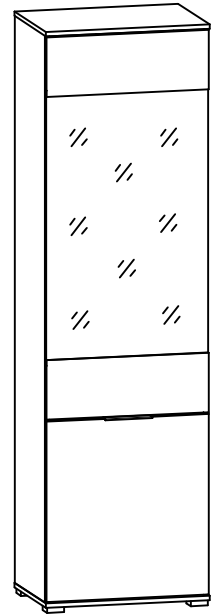

| | | | | | | | | |
|-------------|-----------|------------|-------------|----------|-----------|-------------|-------------|-------------|
| 4x a44 | 4x b19 | 1x c409 | 8x d1 | 8x d3 | 4x e1 | 8x e3 | 12x f1 | 4x k82\1 |
| 60x l1 | 4x o21 | 8x p51 | 2x p93 | 8x r1 | 8x r42 | 1x z28\1 | 1x z28\2 | 4x k82\2 |
| 1x z28\3 | 4x s2 | 1x z1 | 3x z28\4 | | | | | |
| | | | | | | 1x n26\1 | 1x p38 | |

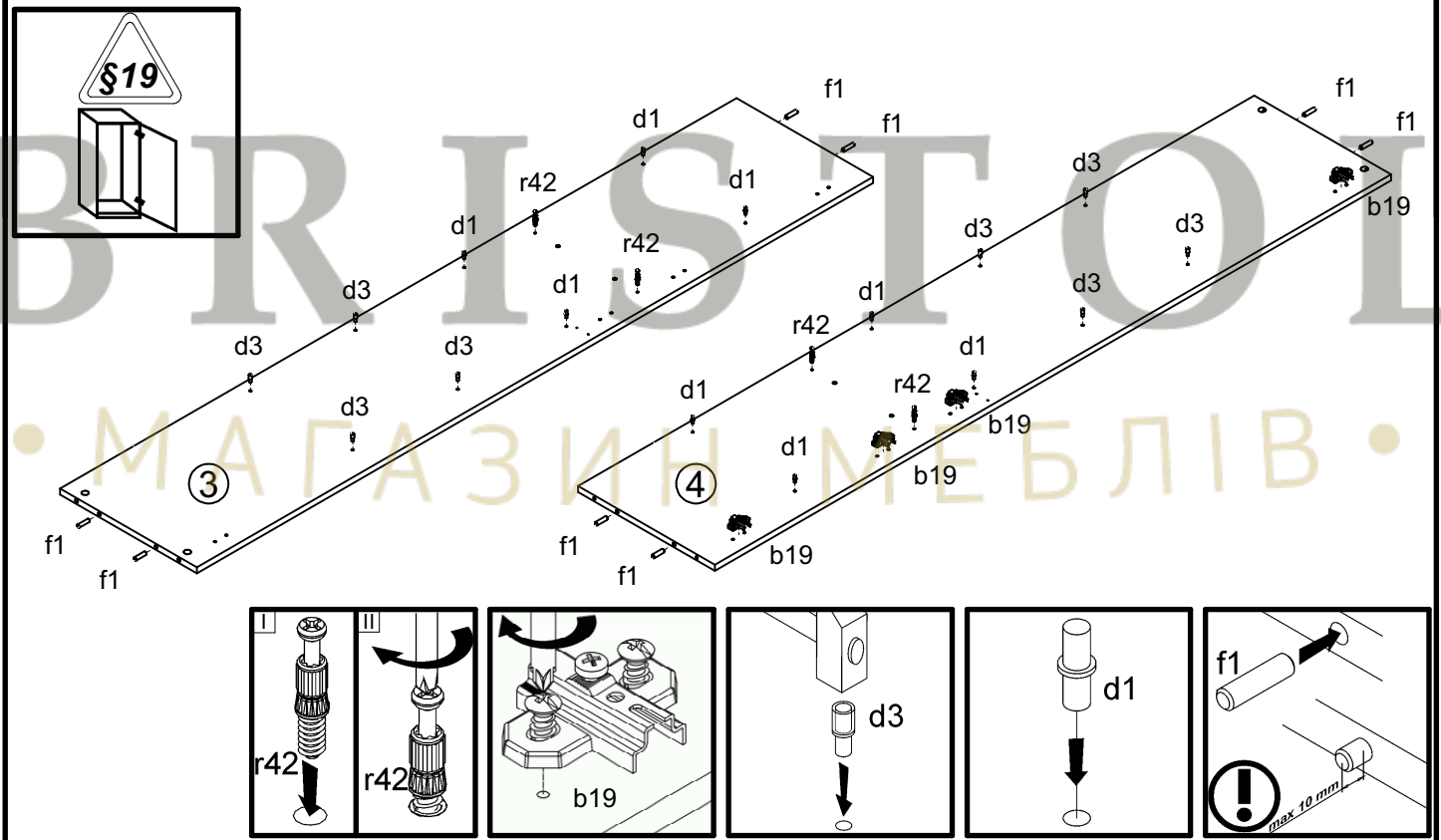
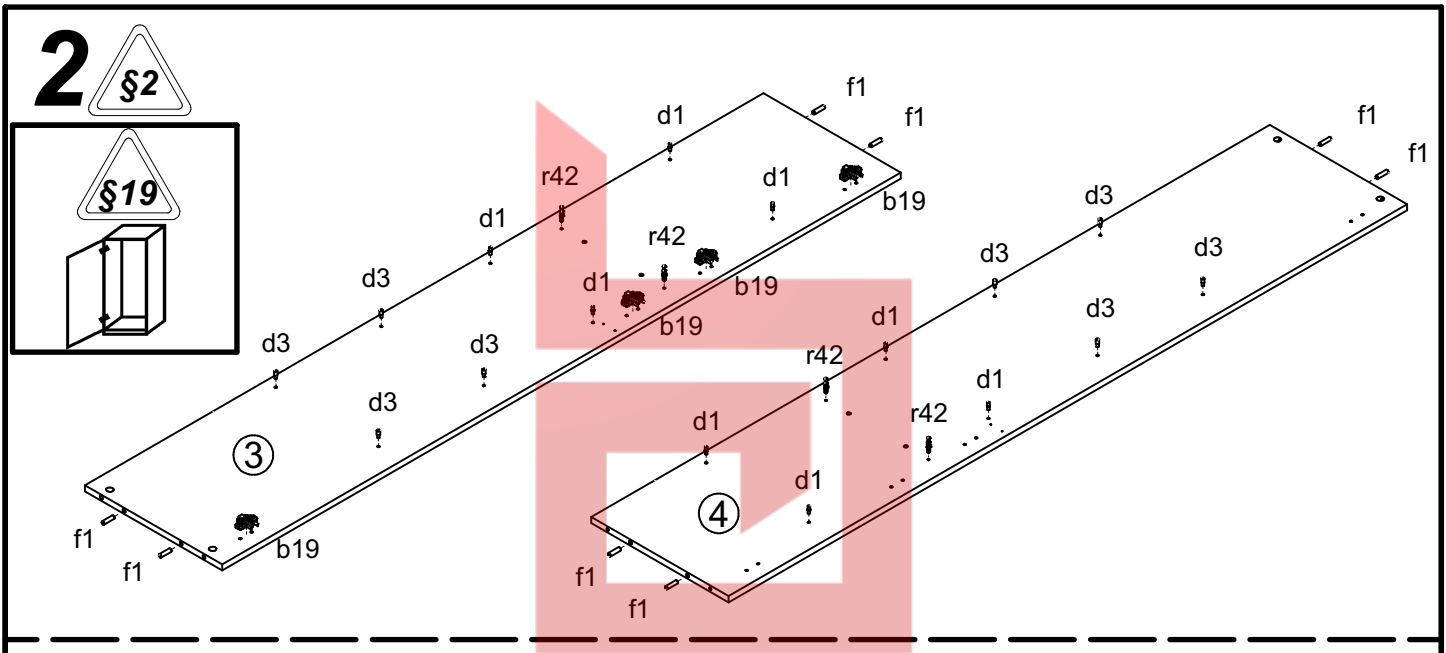
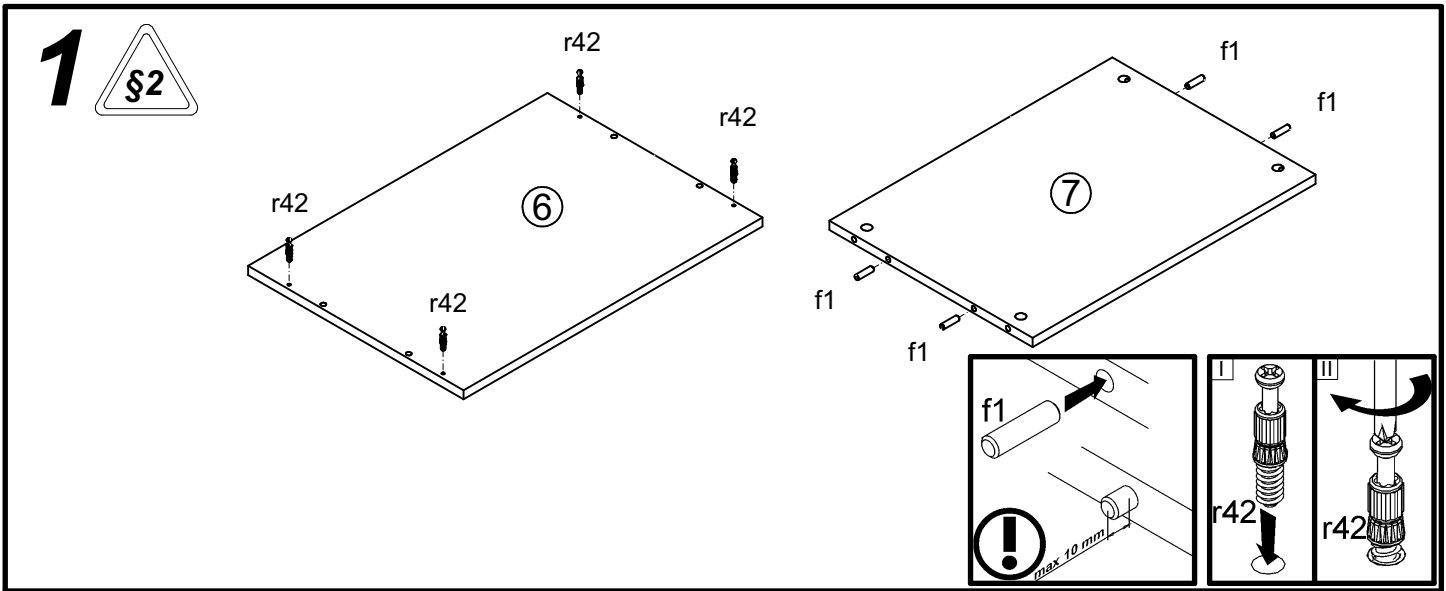

3 §6

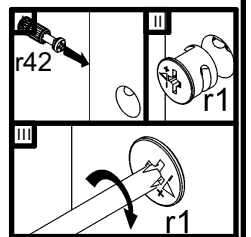
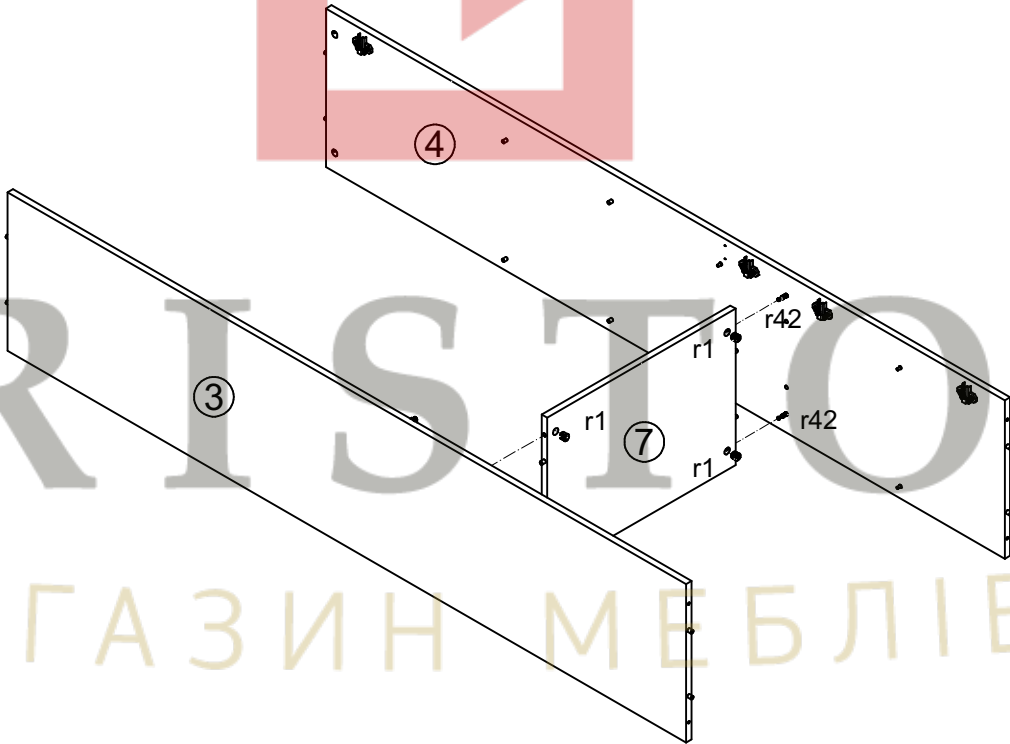
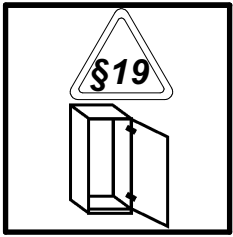
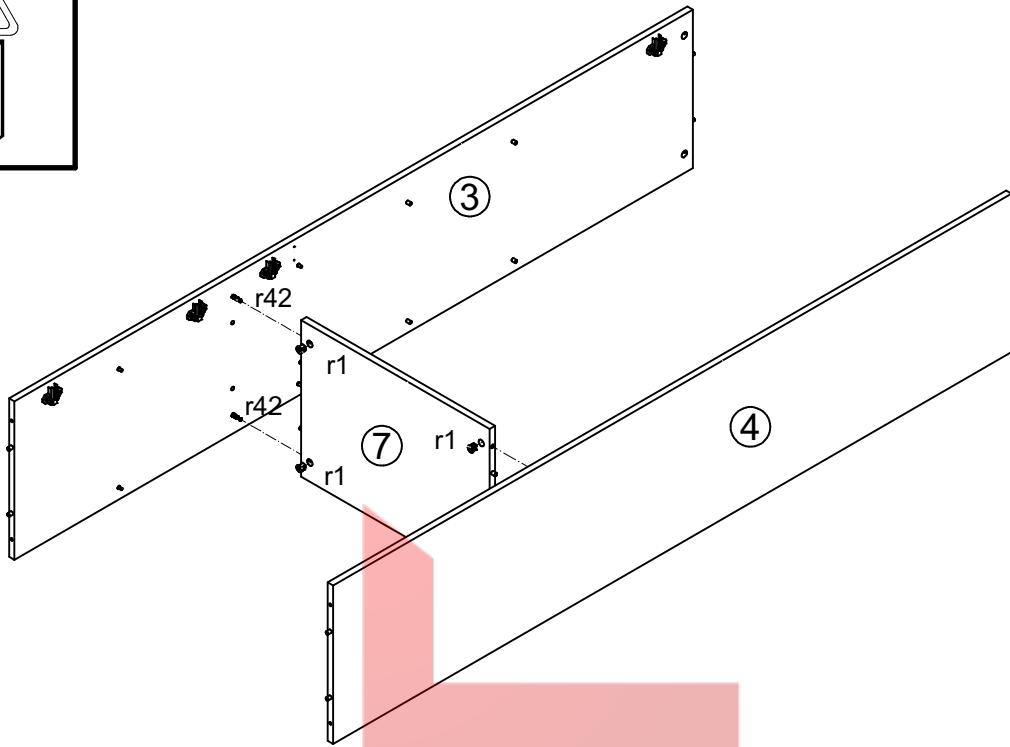
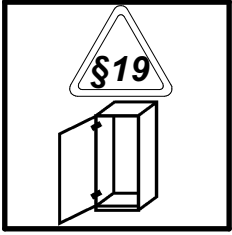

4

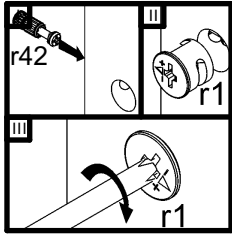
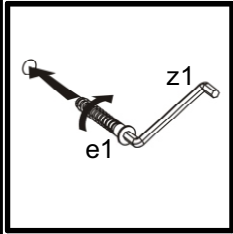
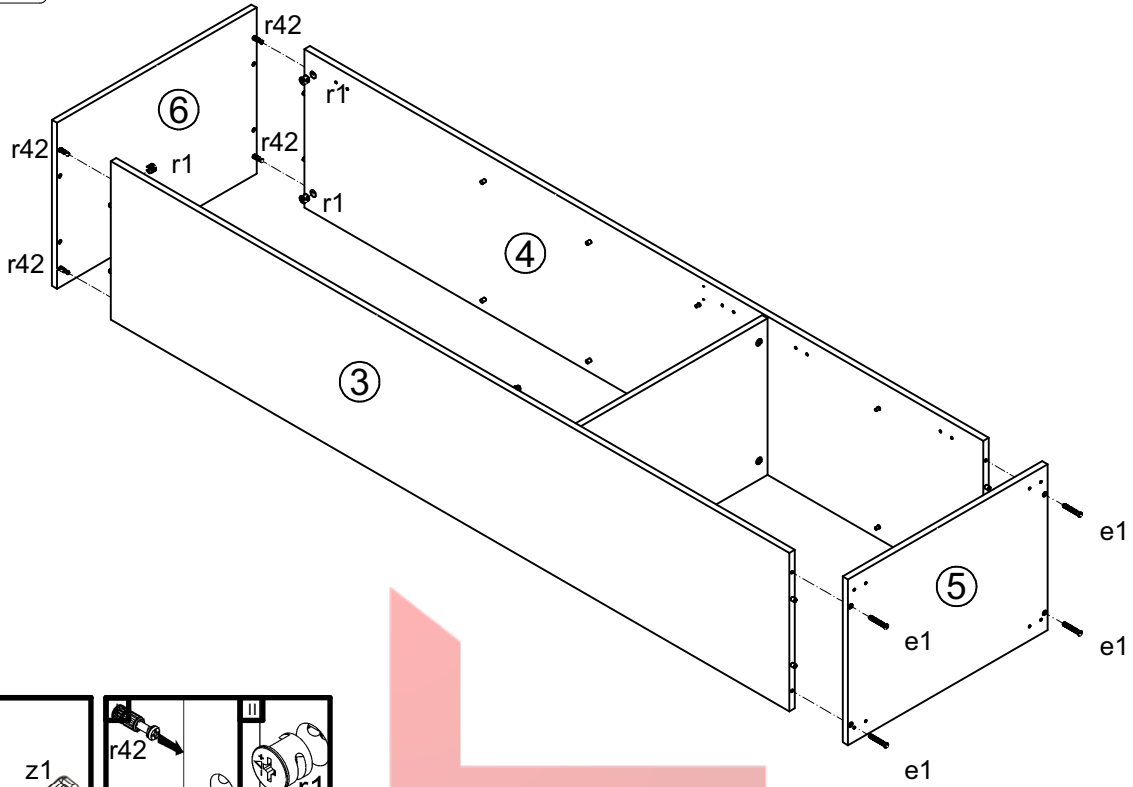

5

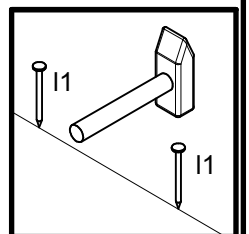
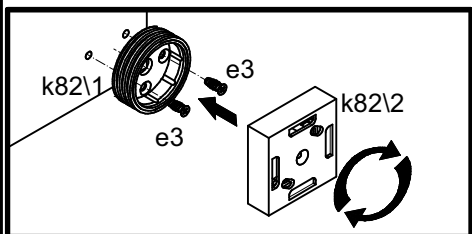
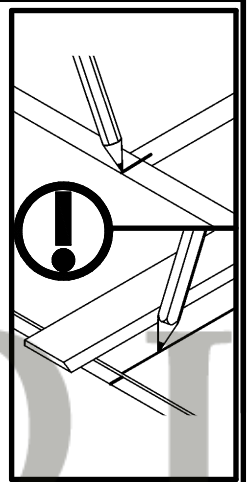
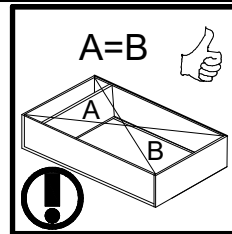
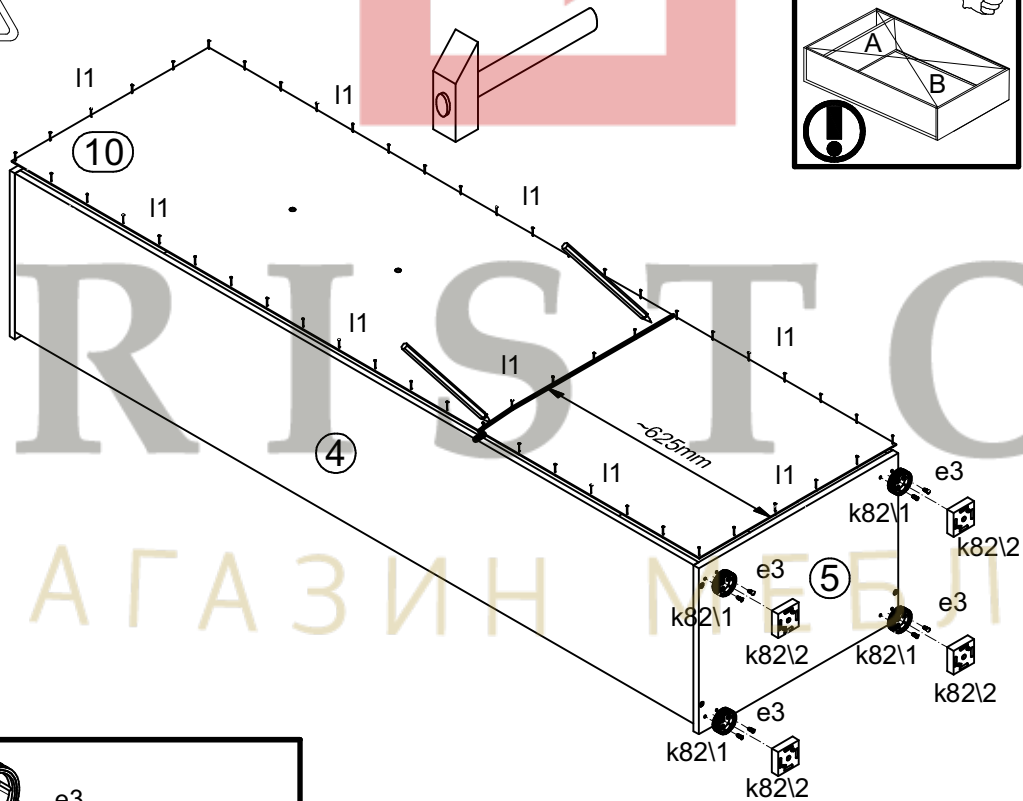

6

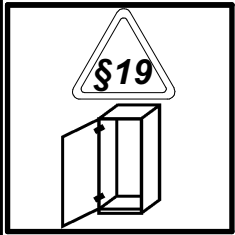

§19

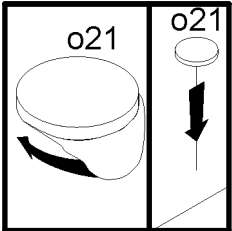
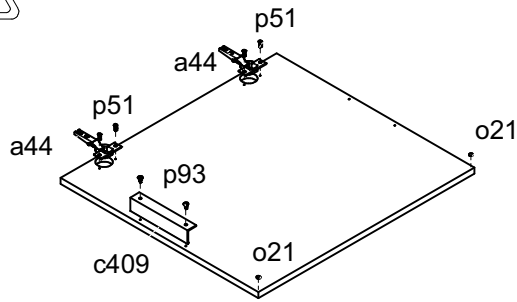

o21



o21

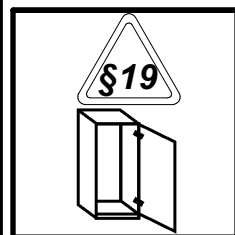
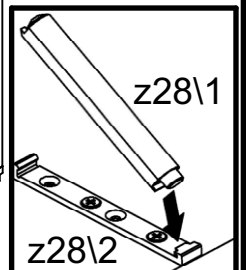
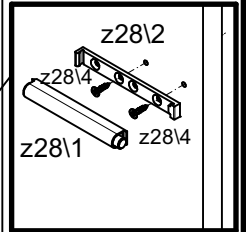
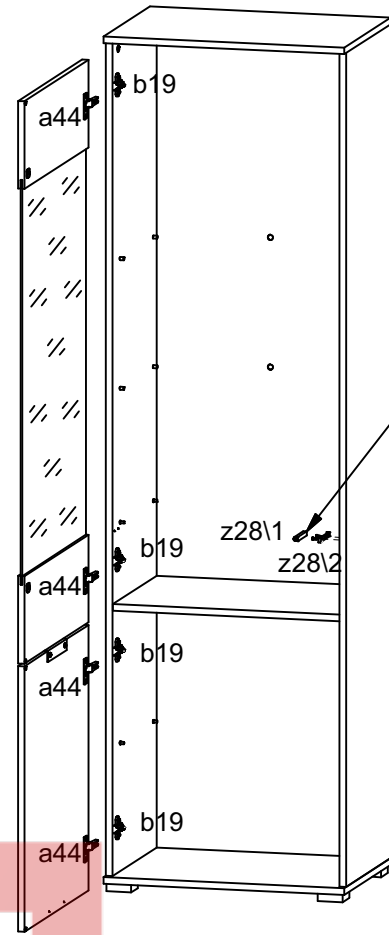
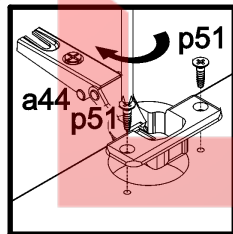
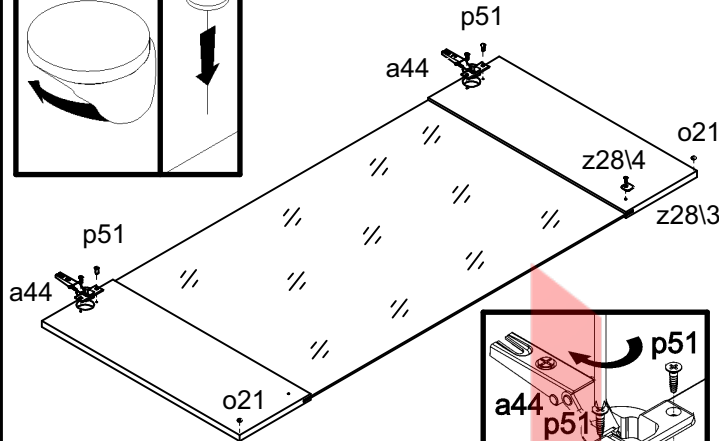

§19

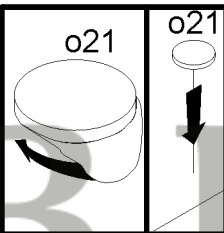
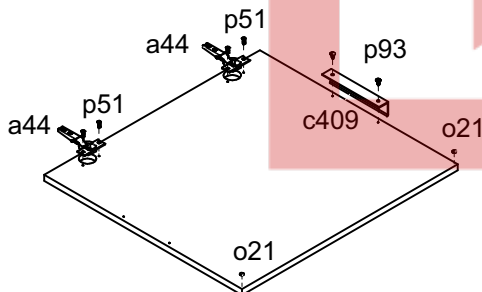

o21



o21

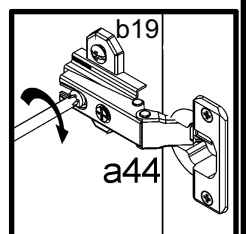
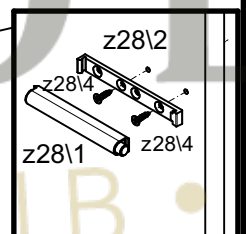
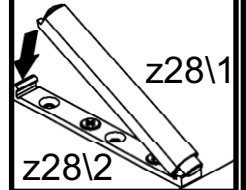
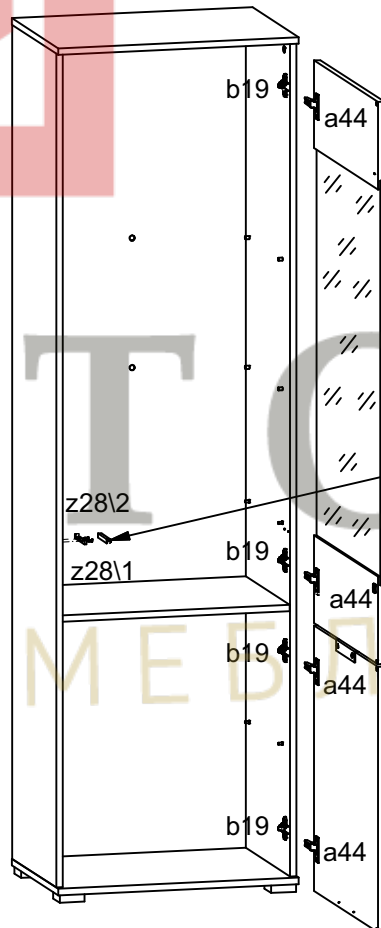
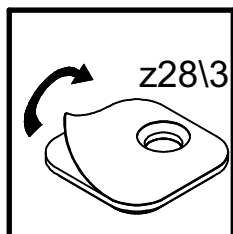
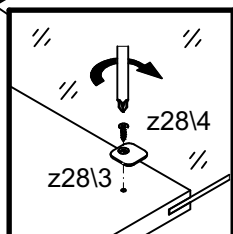
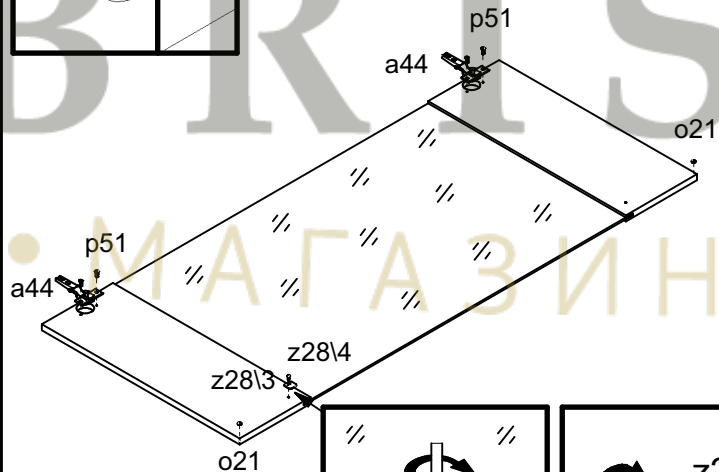

7

