

A	B	C		D
1	S205-027	2071	496	6/7
2	S205-031	2071	596	5/7
3	S205-032	2071	596	5/7
4	S205-045	414	130	3/7
5	S205-145	2043	560	2/7
6	S205-146	2043	540	2/7
7	S205-148	2043	580	1/7
8	S205-150	2043	580	1/7
9	S205-162	678	443	4/7
10	S205-225	2199	580	2/7
11	S205-226	2199	580	2/7
12	S205-319	479	460	4/7
13	S205-321	1075	560	3/7
14	S205-325	579	540	3/7
15	S205-333	580	540	4/7
16	S205-414	678	60	3/7
17	S205-505	400	105	3/7
18	S205-506	400	105	3/7
19	S205-510	380	91	3/7
20	S205-587	445	100	3/7
21	S205-913	2053	594	1/7
22	S205-917	2053	491	1/7
23	S205-969	394	408	4/7
24	S205-964	2053	544	1/7
25	dr-1071	1071	30	3/7
26	dr-475	475	22	3/7
27	Lh-2035	2035	14	1/7

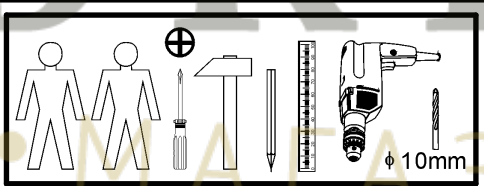

8x a102	8x a103	16x b59	16x d1	31x e1	65x f1	1x k53	4x k84	4x k85
30x l1	30x l2	6x n1	26x n108	4x p1	1x p36	41x p38	32x p51	34x p55
8x p6	58x r1	58x r42	52x s2	1x z1	1x n261	1x p38	4x w75 ^P	4x w75 ^L
1x f3	1x p17	34x e3	1x qb18	24x s4				

§2 1

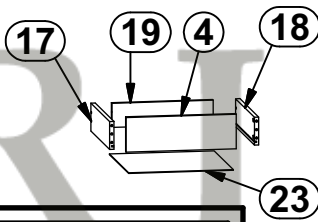
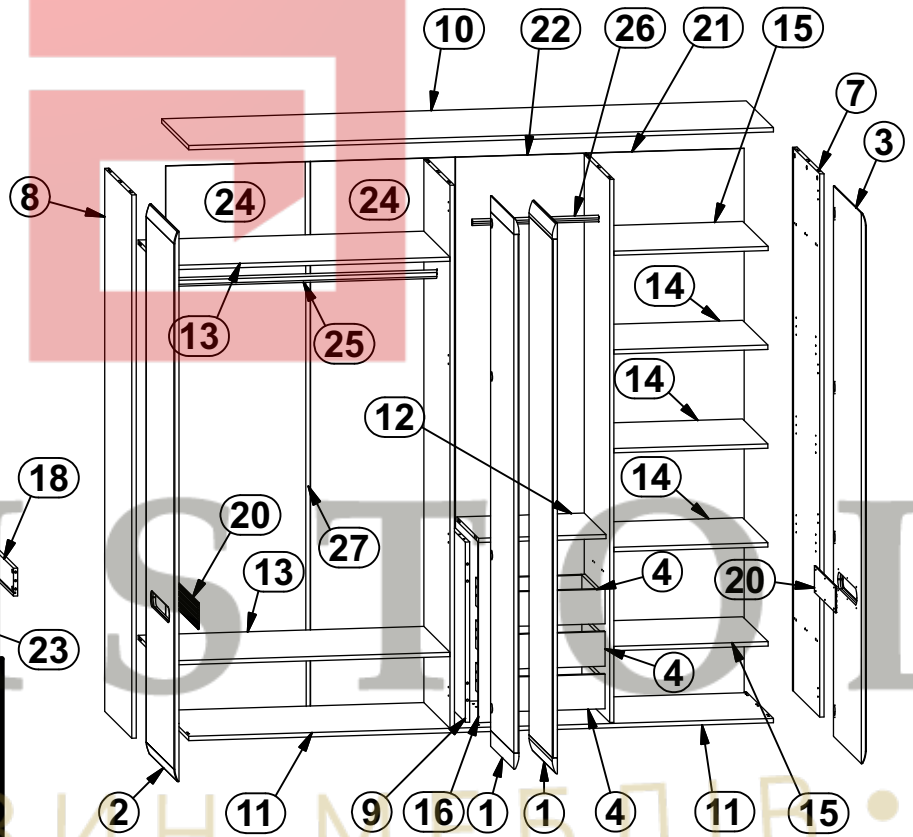
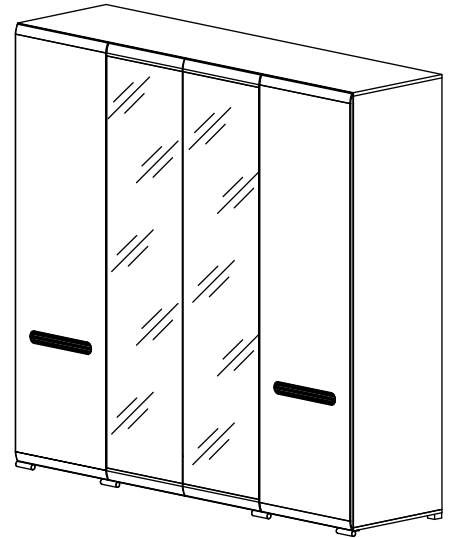
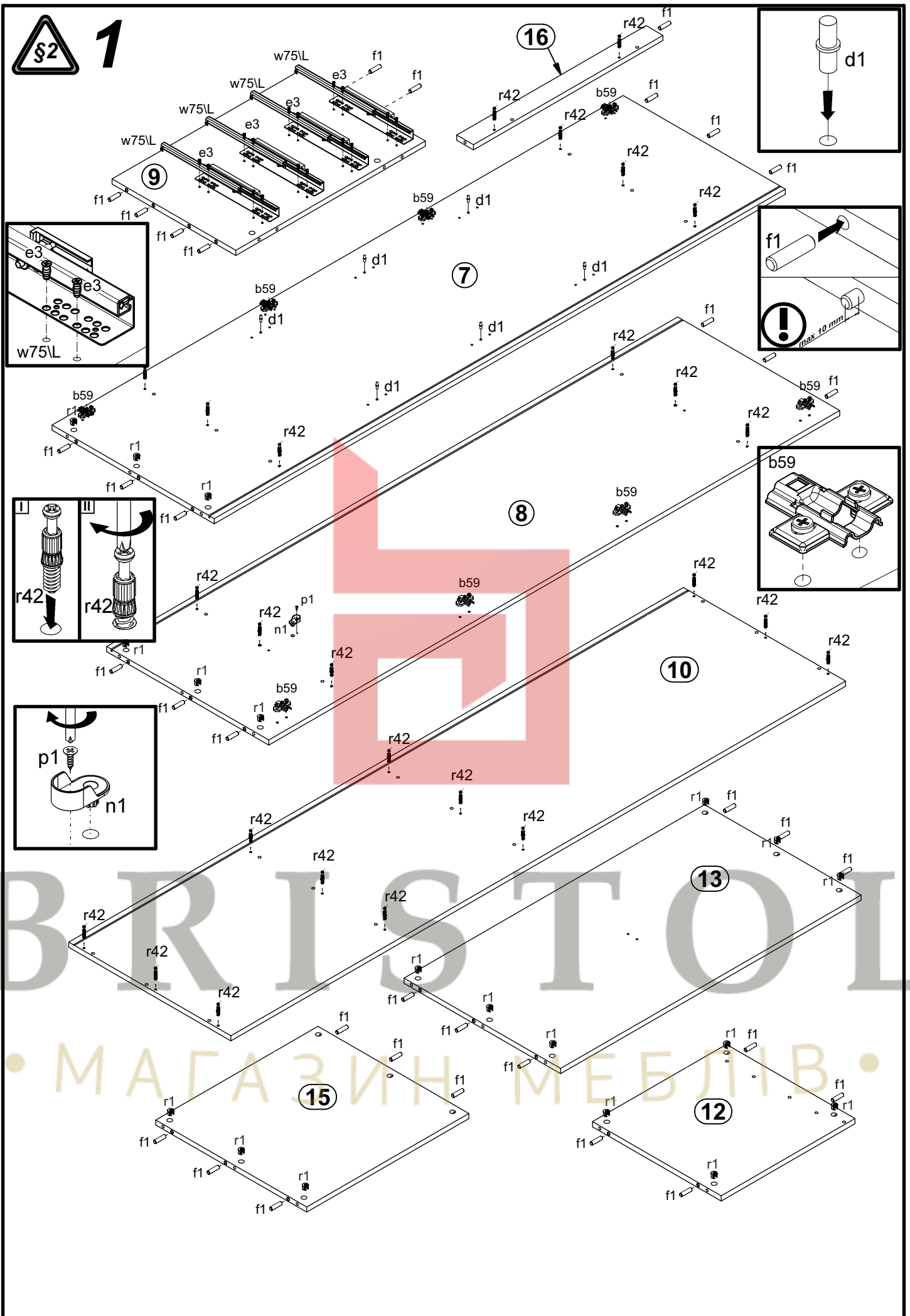

§2 1

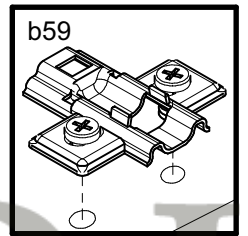
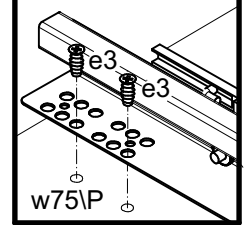
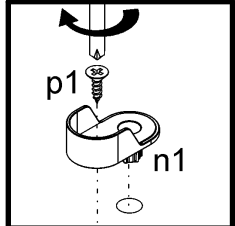
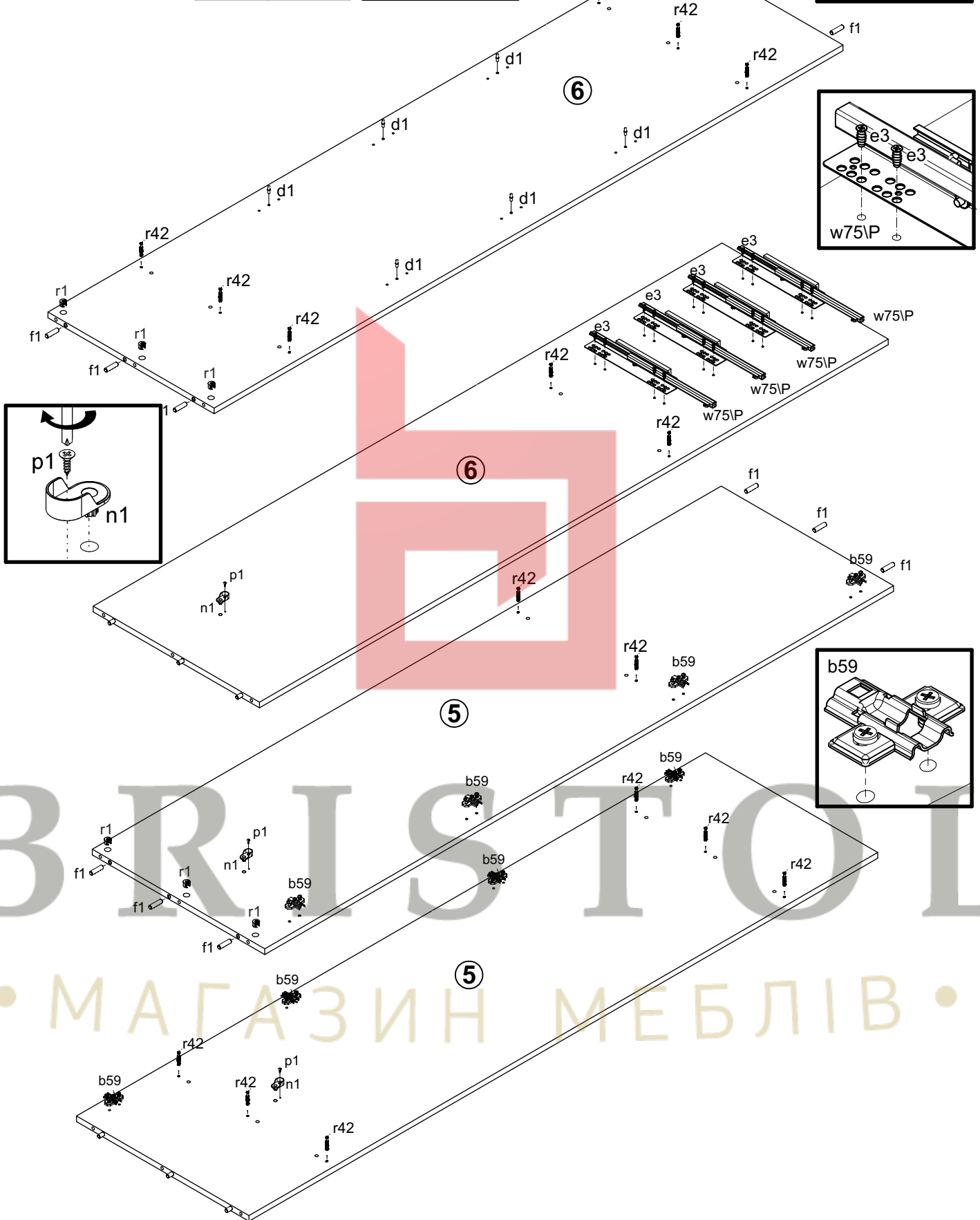
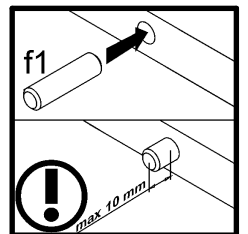
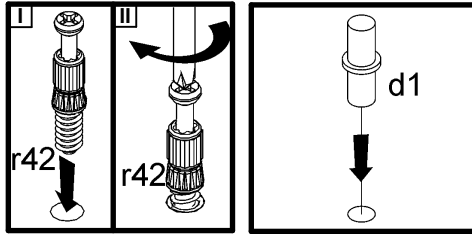

1

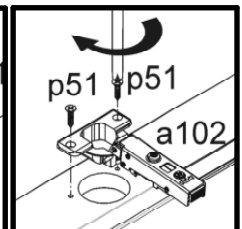
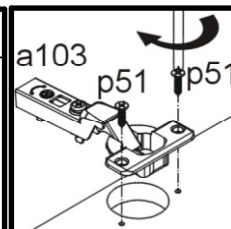
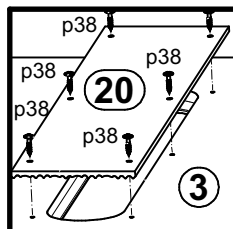
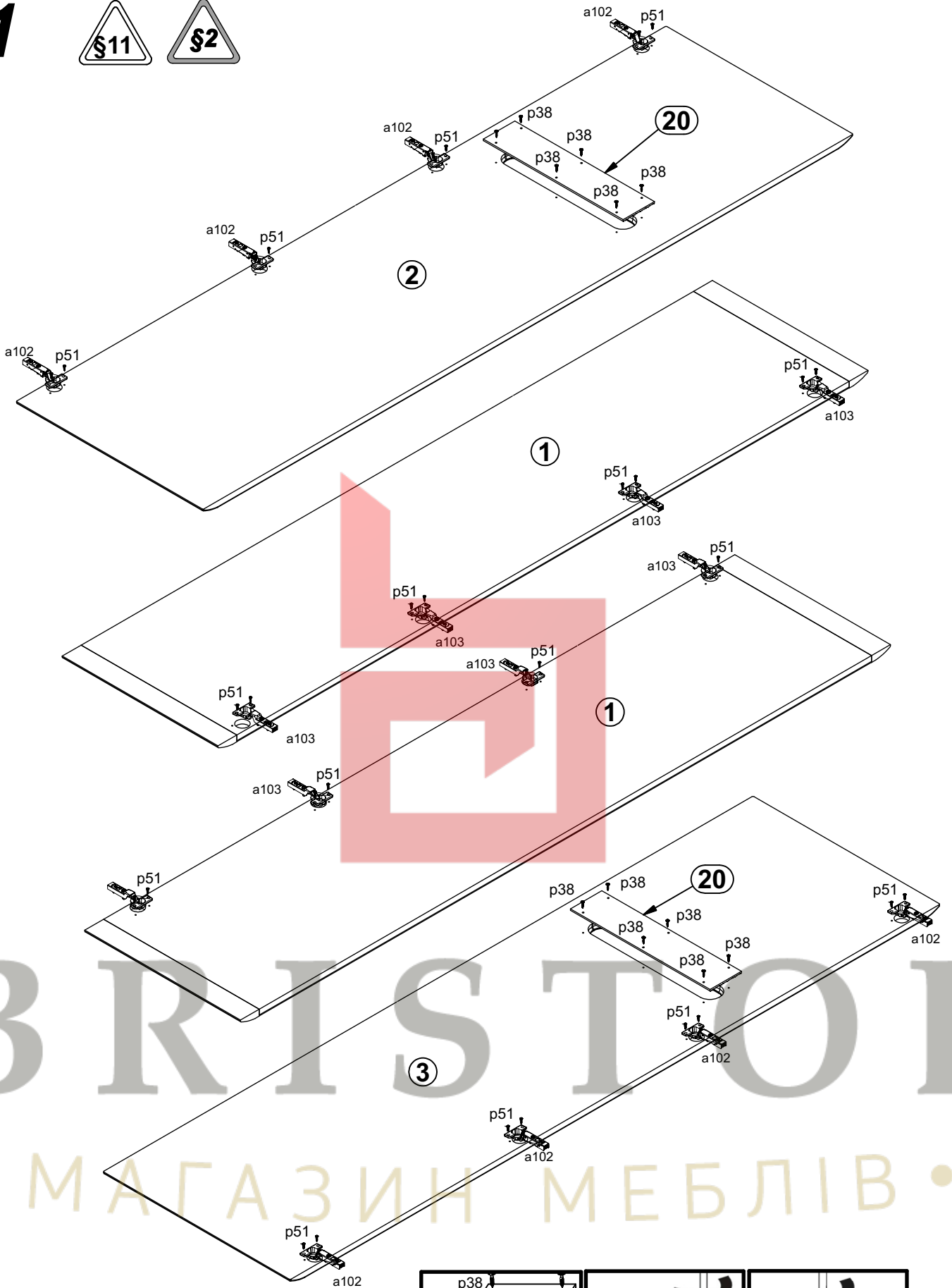

2

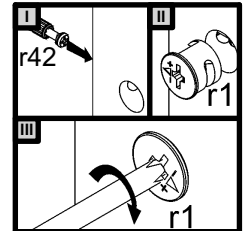
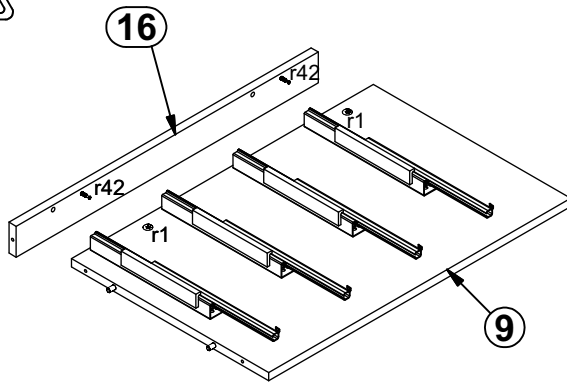

3

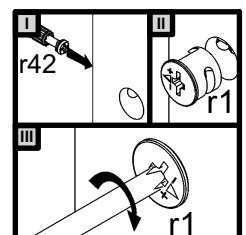
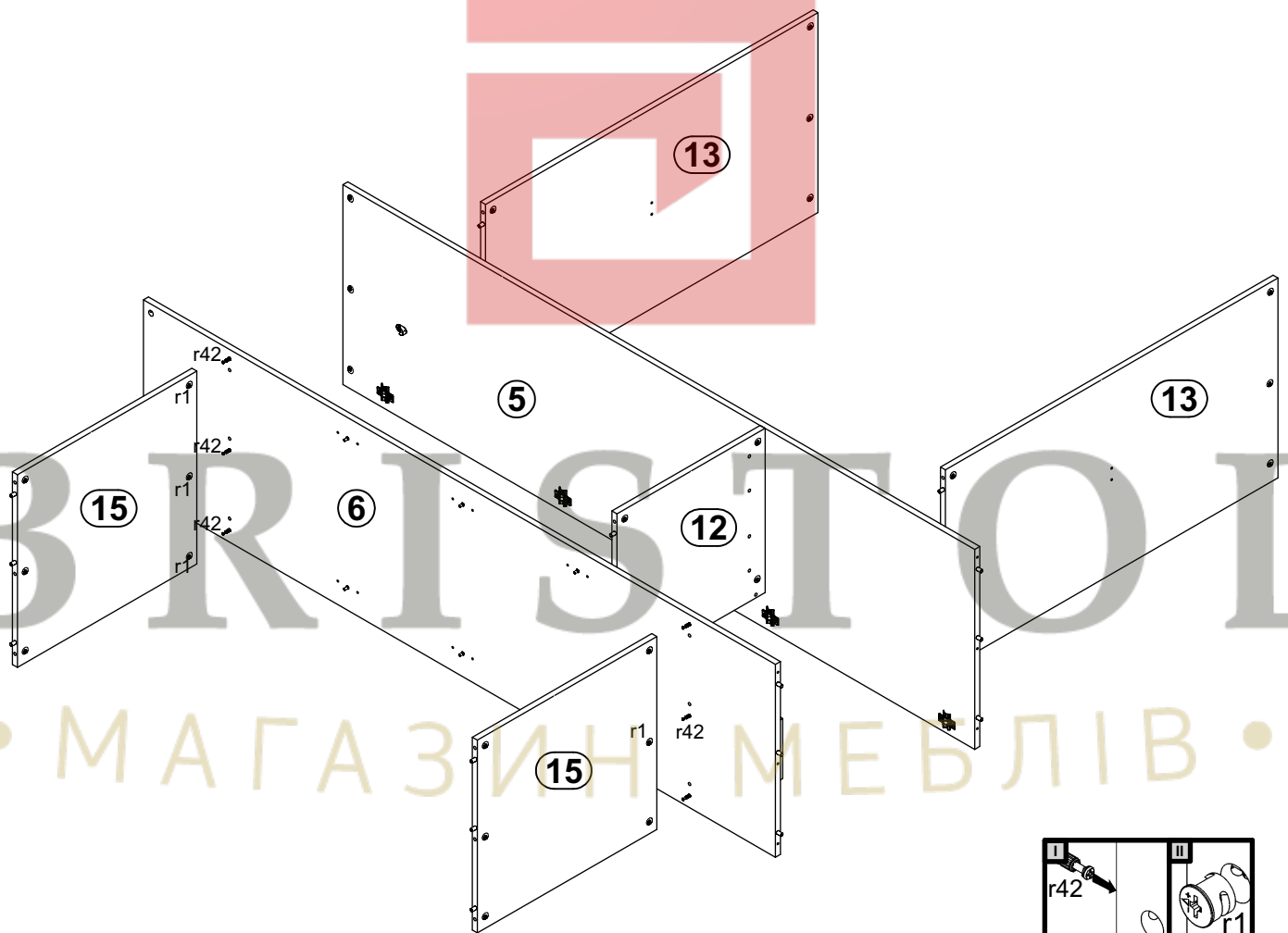

4

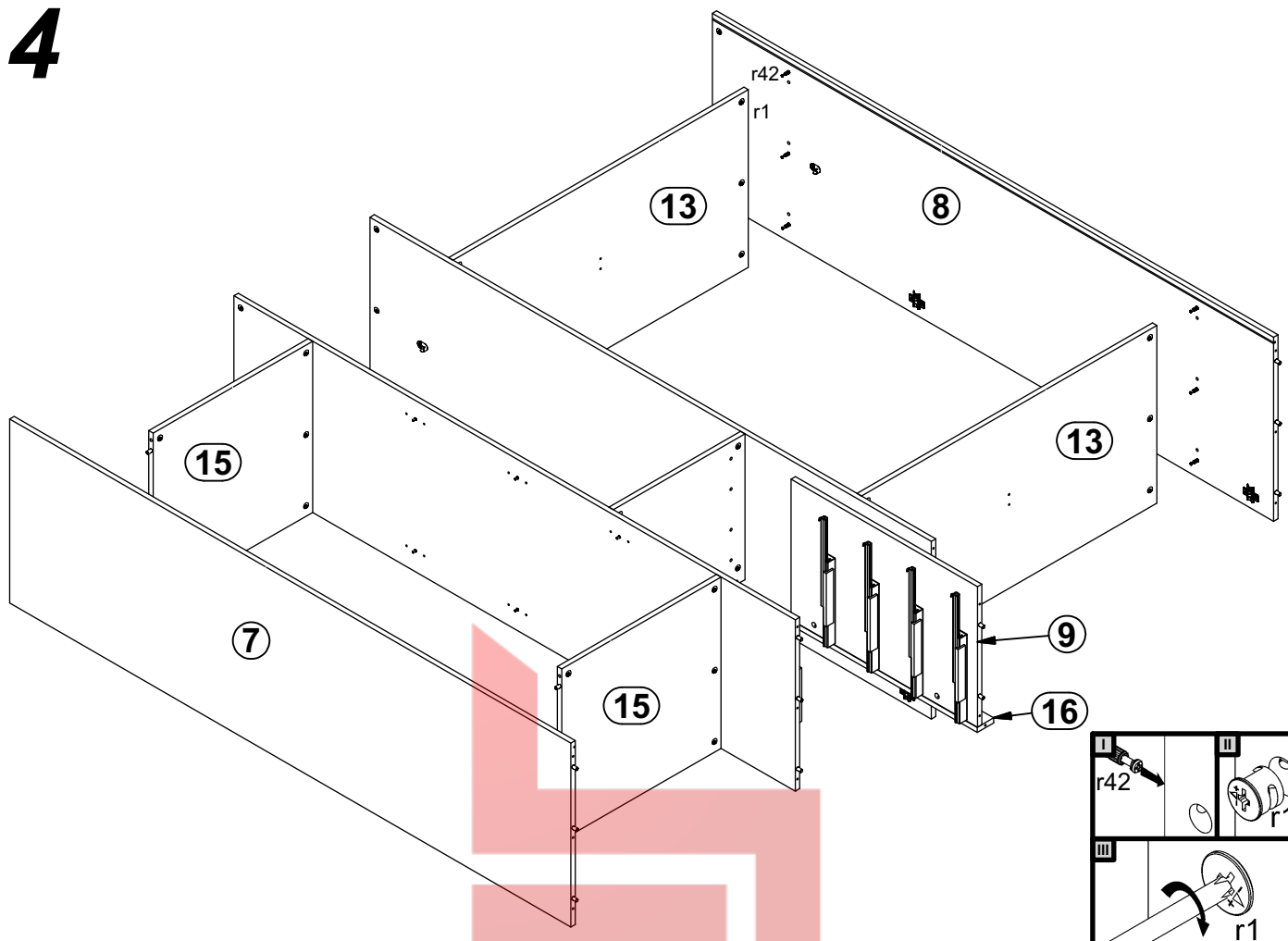

5

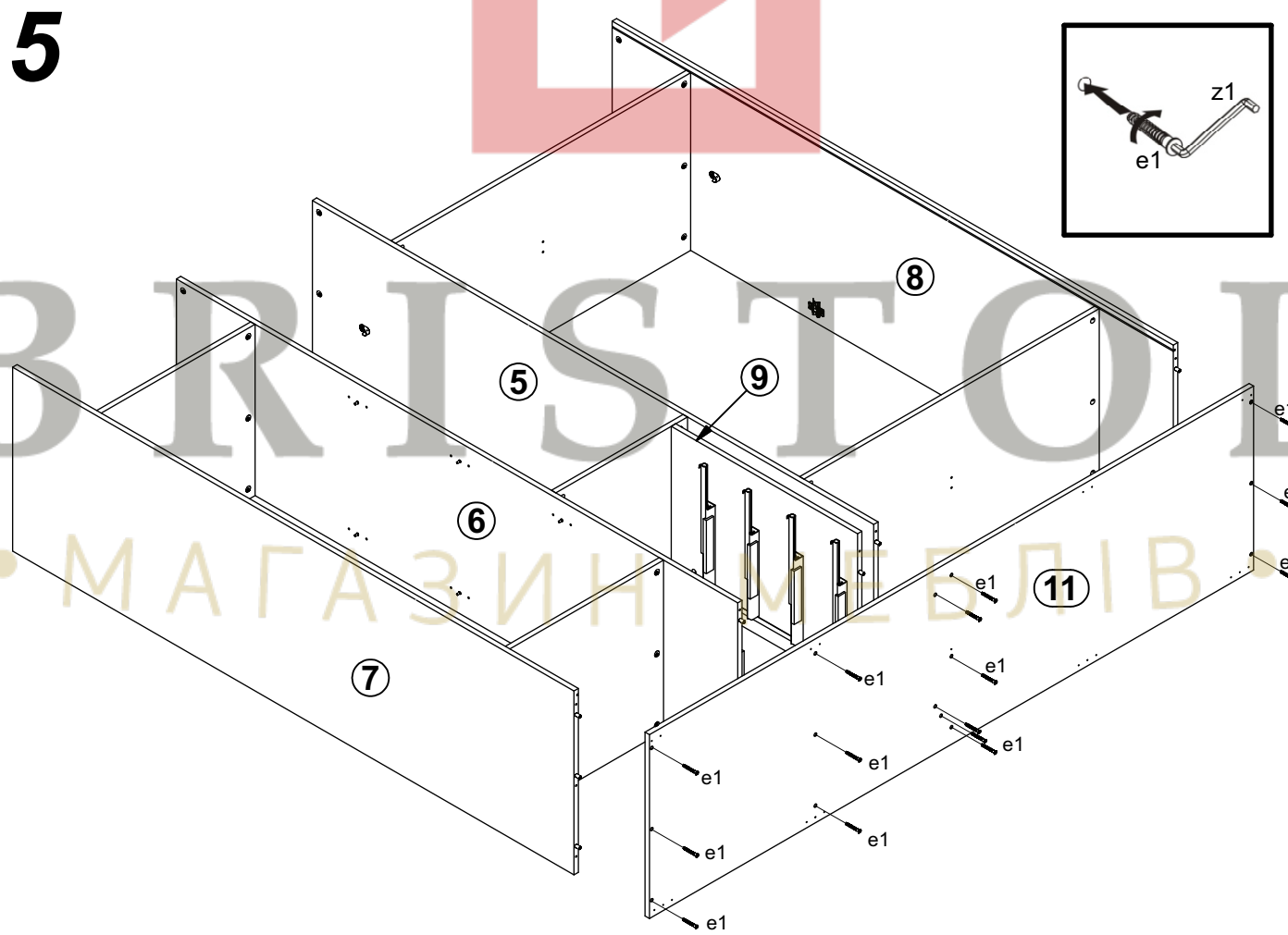

6

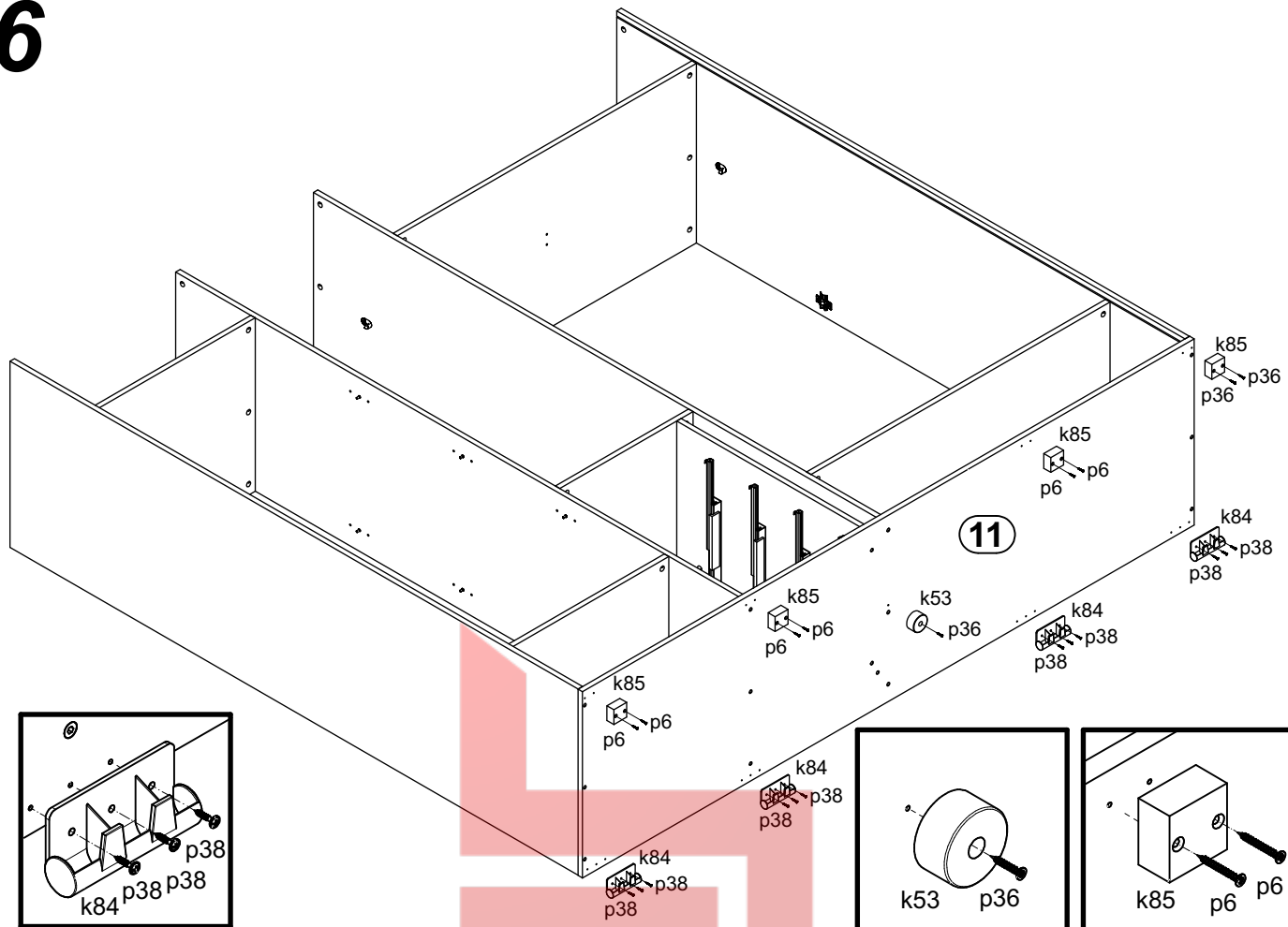

7

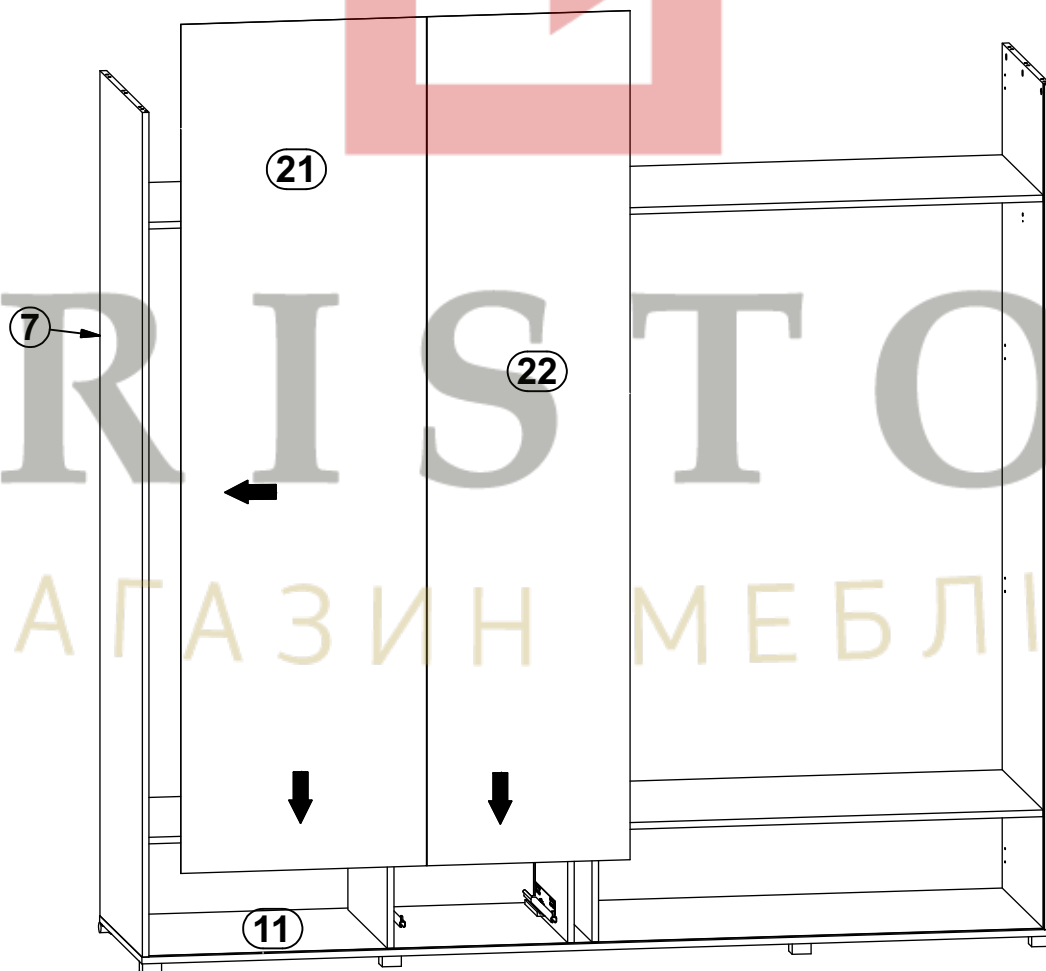

8

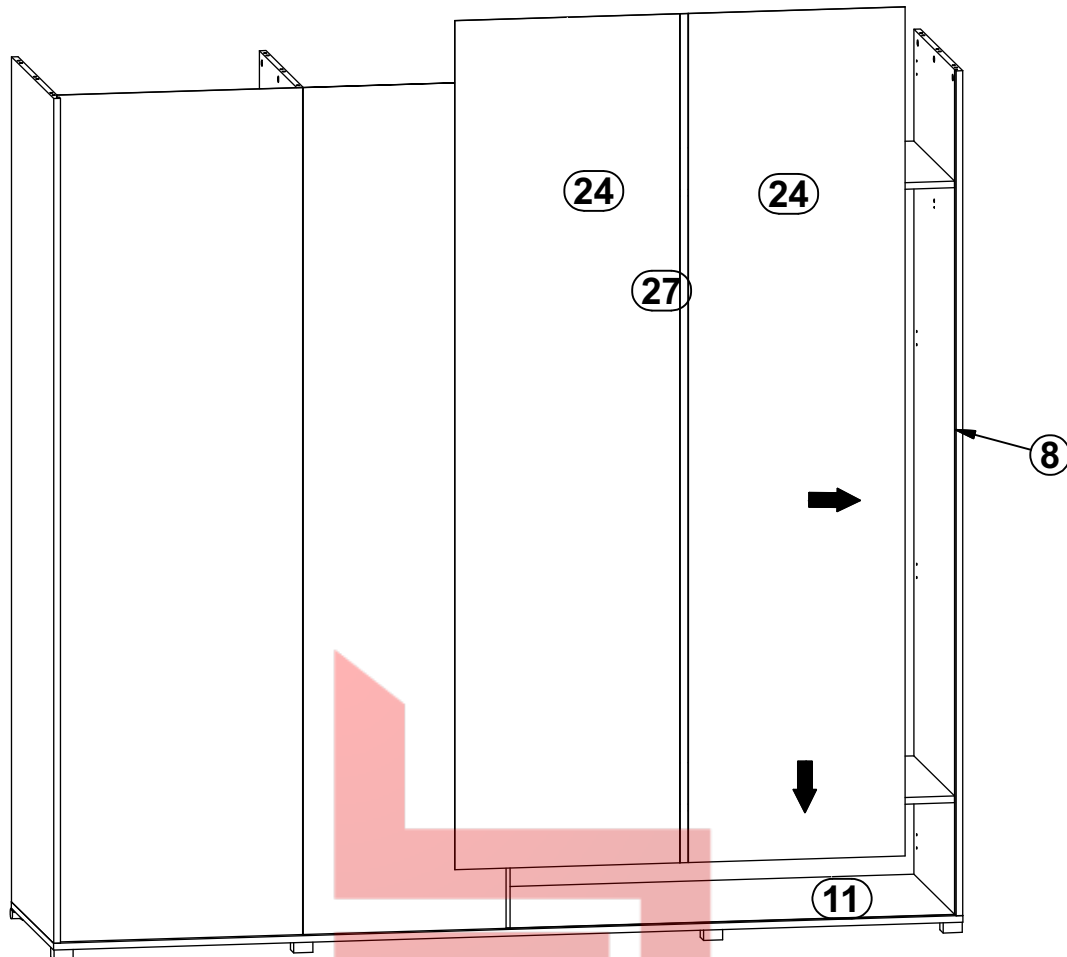

9

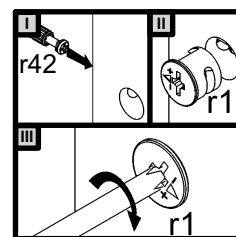
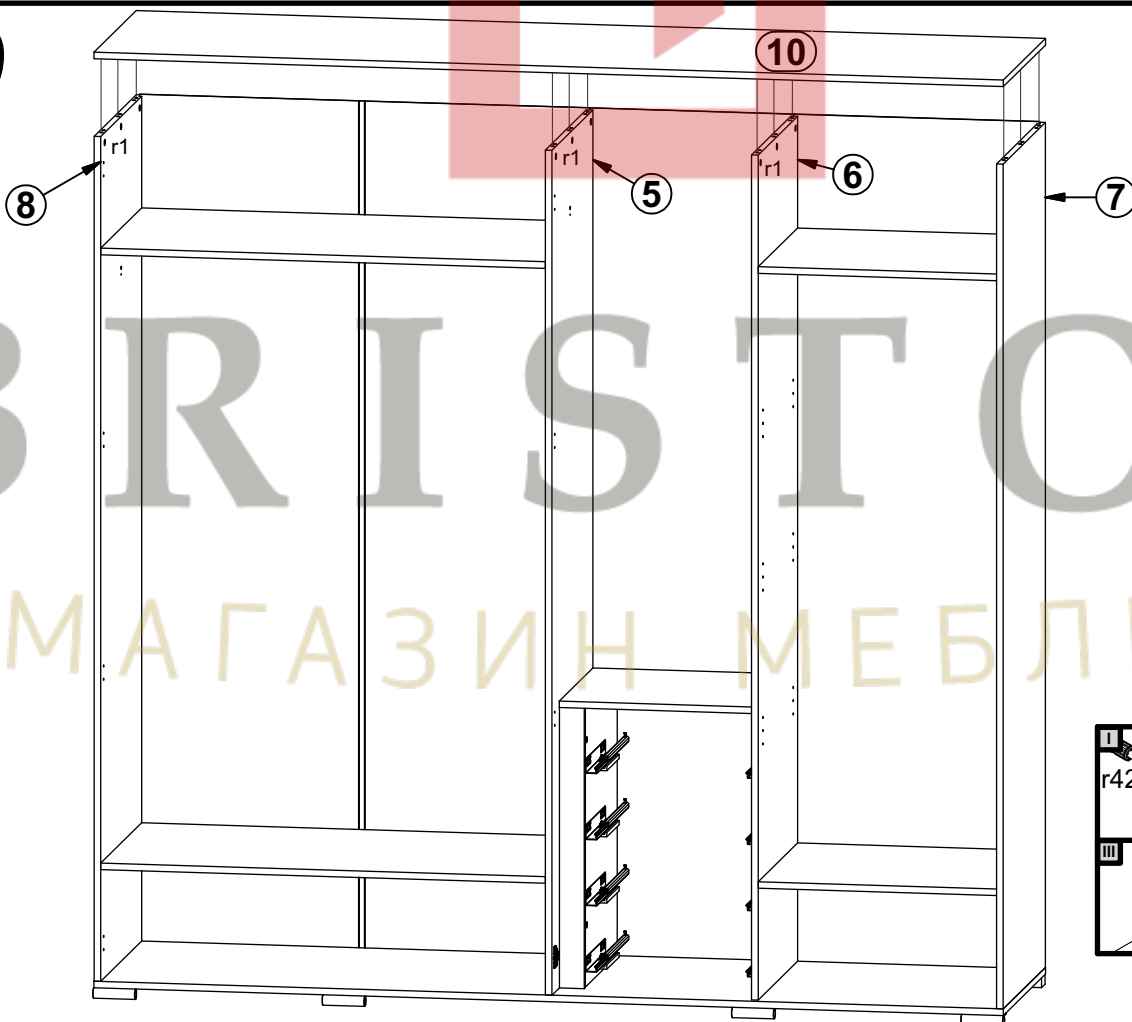

12

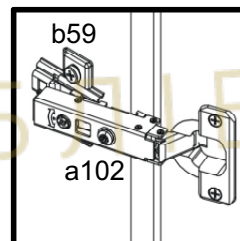
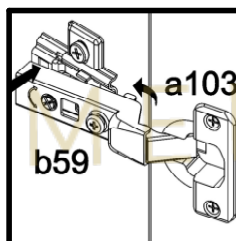
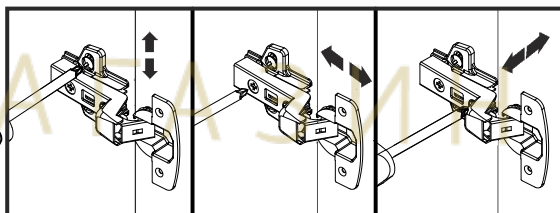
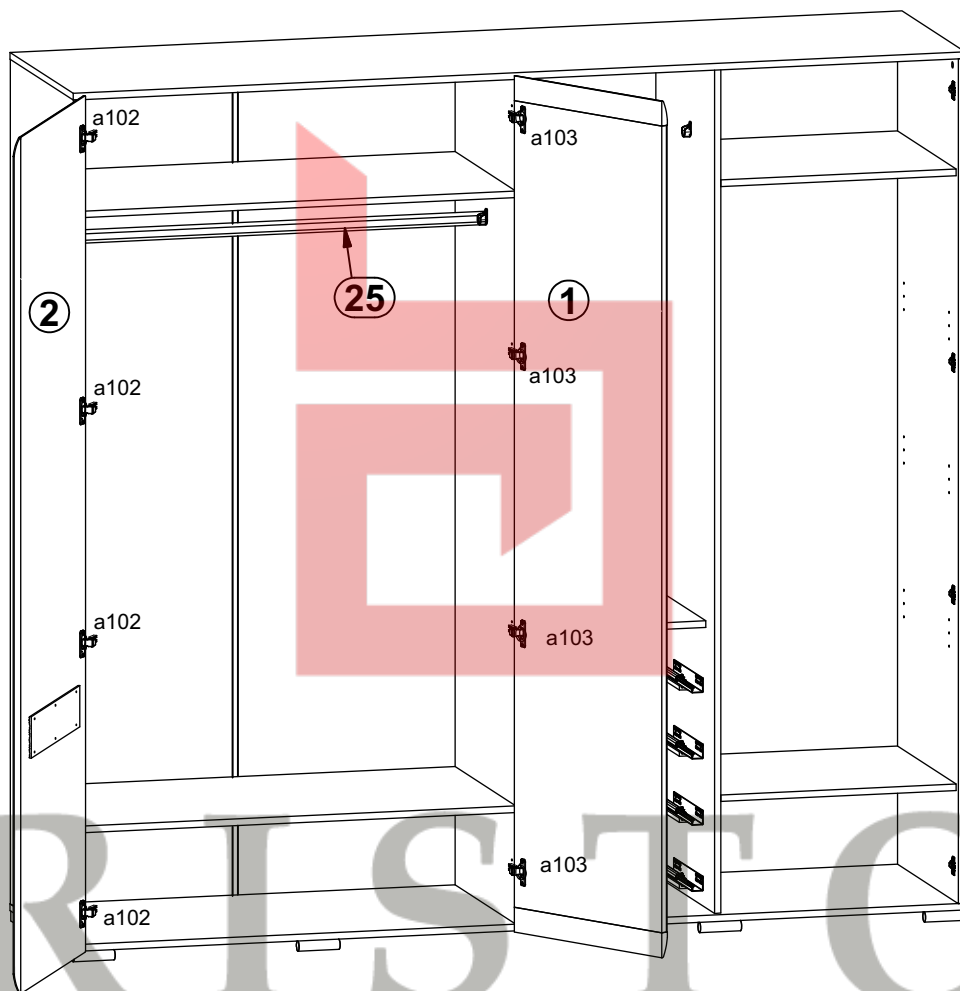
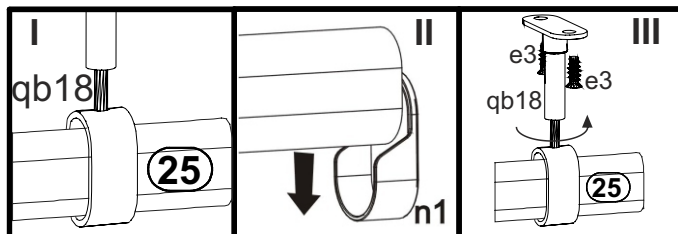
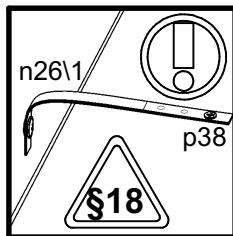

13

