

ЛЕНА

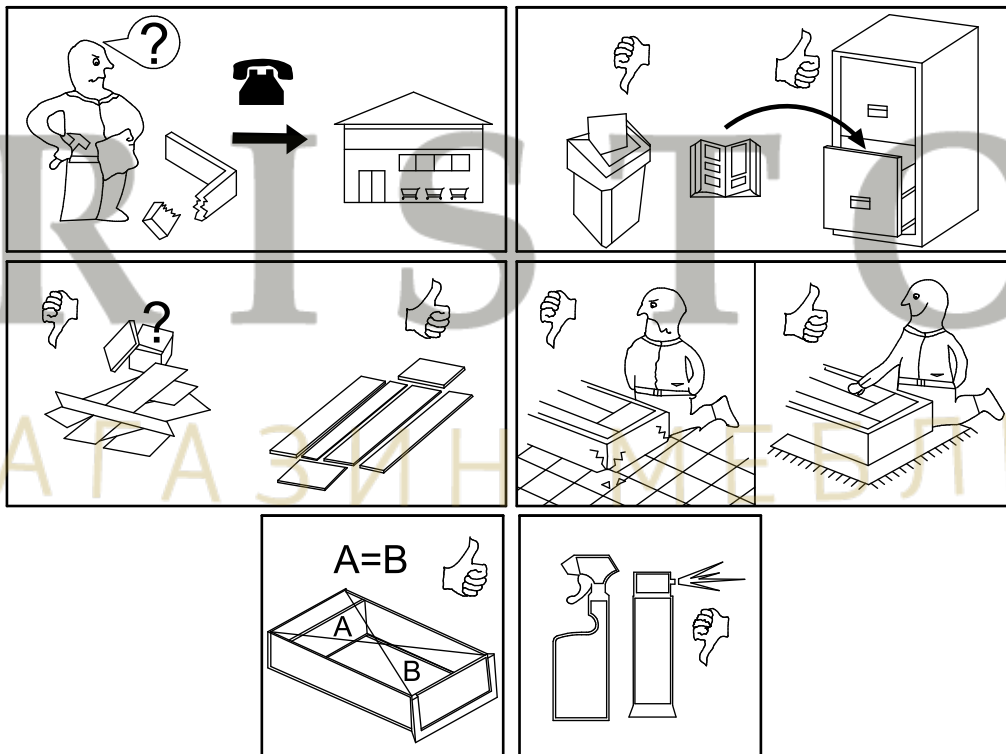

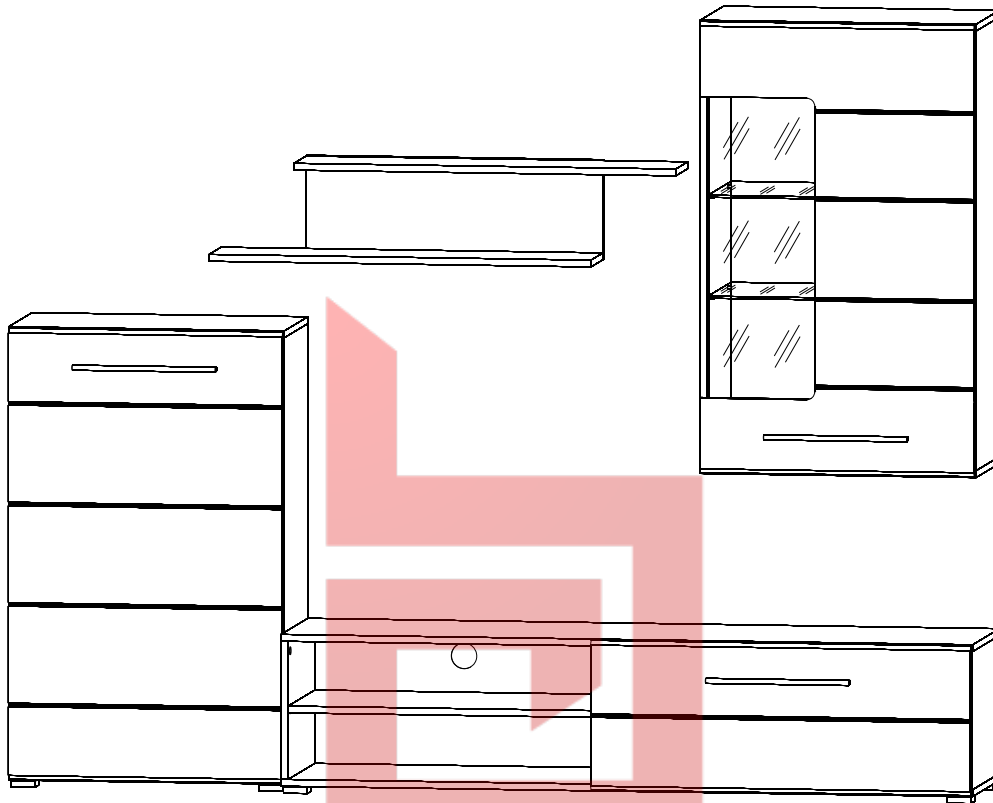

2x K16 a43	6x K0 a44	8x b19	3x L 340 mm c520	12x φ5x17 mm d1	8x φ5x17 mm d3
26x φ7x50 mm e1	2x φ6,3x13 mm e2	4x φ5x11 mm e4	28x φ8x30 mm f1	2x g2	9x 56x56x20 mm k52
110x i1	7x 3 mm i3	1x m48	2x n2	2x 50x12x1,5 mm n3	2x n10
1x 81x21x15/1,5 mm n14	2x n122/1	4x silikon φ8x1,8 mm o21	2x o43/1	1x o43/6	
4x φ3,5x13 mm p1	6x φ3,5x13 mm p5	9x φ4x30 mm p9	22x φ4x30 mm p21	16x φ3,5x15 mm p51	7x φ3x16 mm p52
4x φ3x10 mm p400	14x φ15x12 mm #16 r1	14x 20/11 r42	4x s1	12x ø16 s2	1x z1

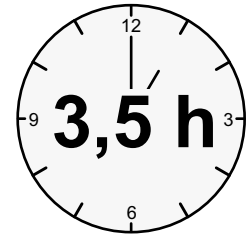
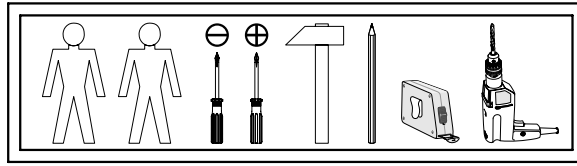
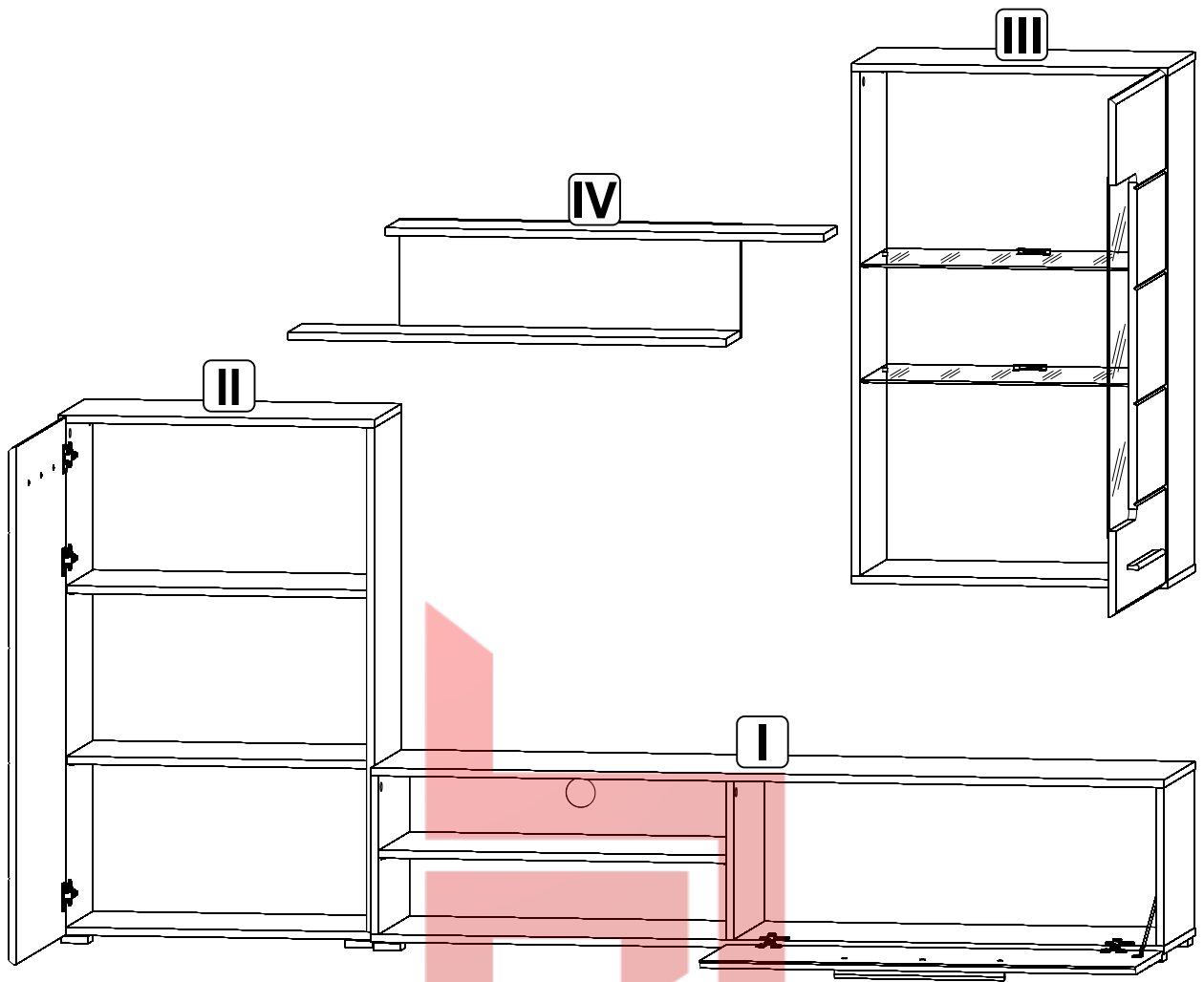
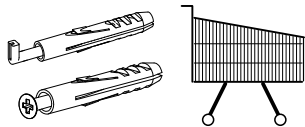

I Тумба РТВ

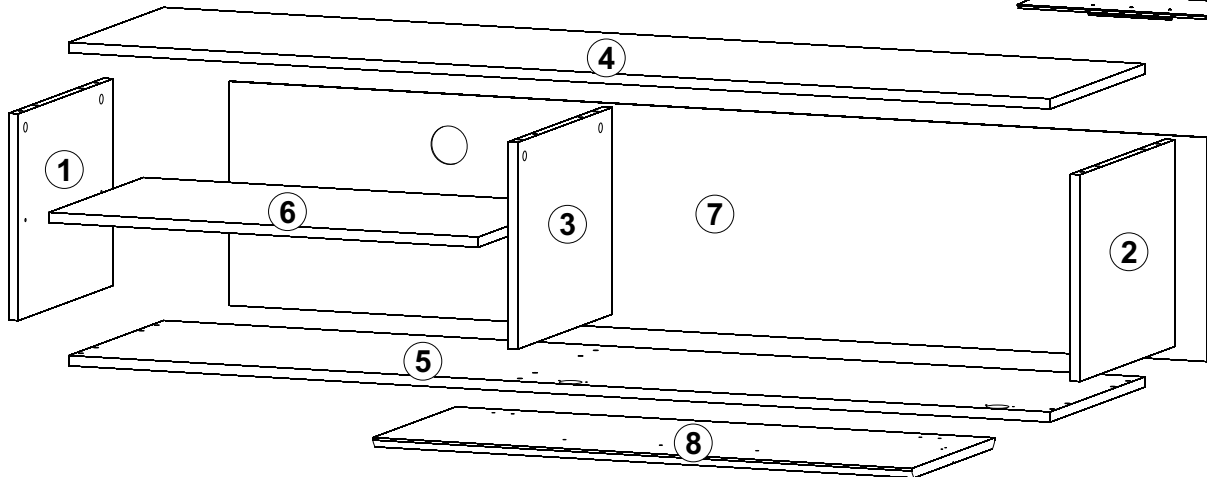
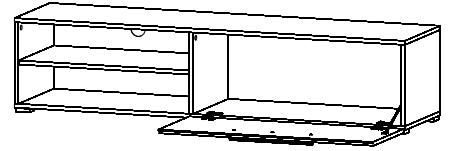

A	B	C	D	A	B	C	D		
1	ML1-105	323	400	1/3	5	ML1-205	1630	400	1/3
2	ML1-106	323	400	1/3	6	ML1-302	713	398	1/3
3	ML1-107	323	400	1/3	7	ML1-903	1624	350	1/3
4	ML1-204	1630	400	1/3	8	ML1-002-01	895	350	3/3



1 §2

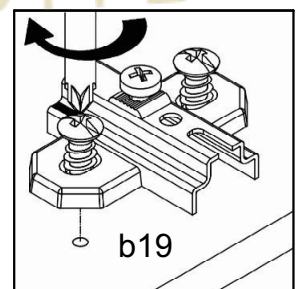
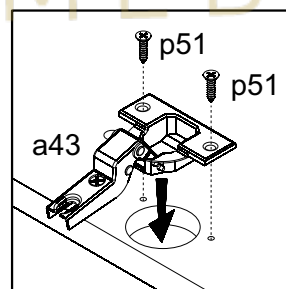
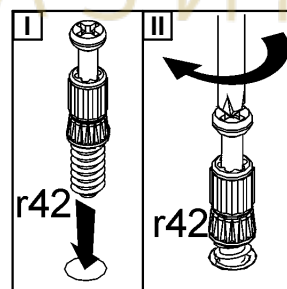
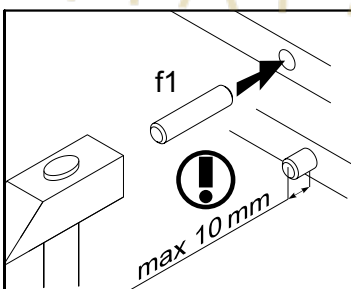
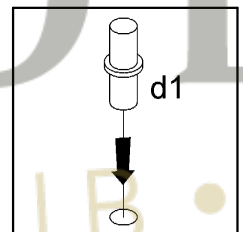
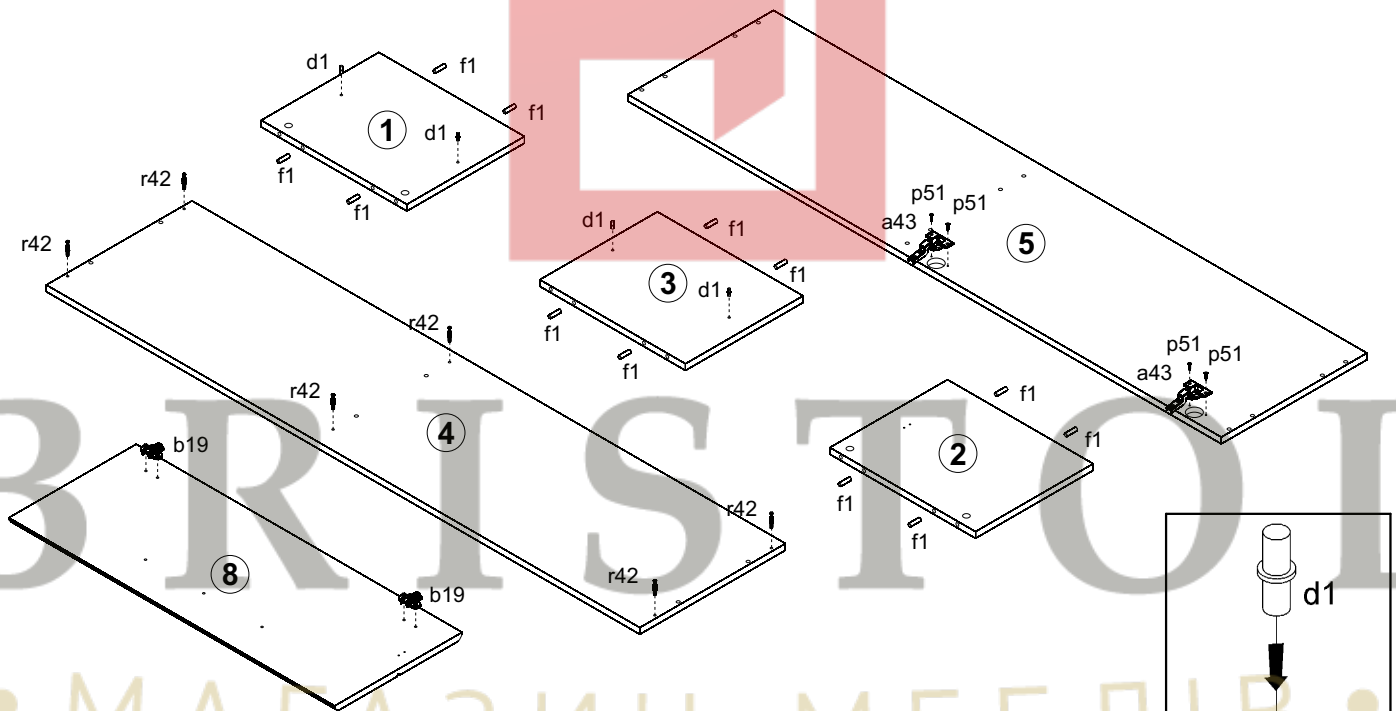
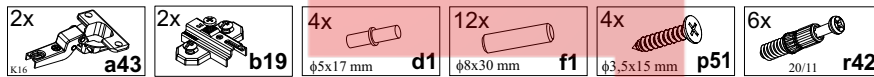

2

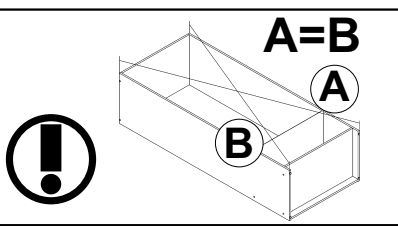
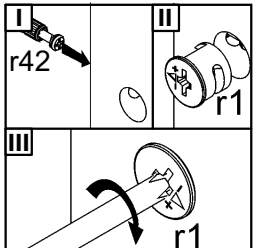
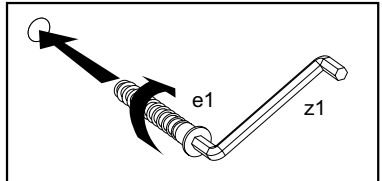
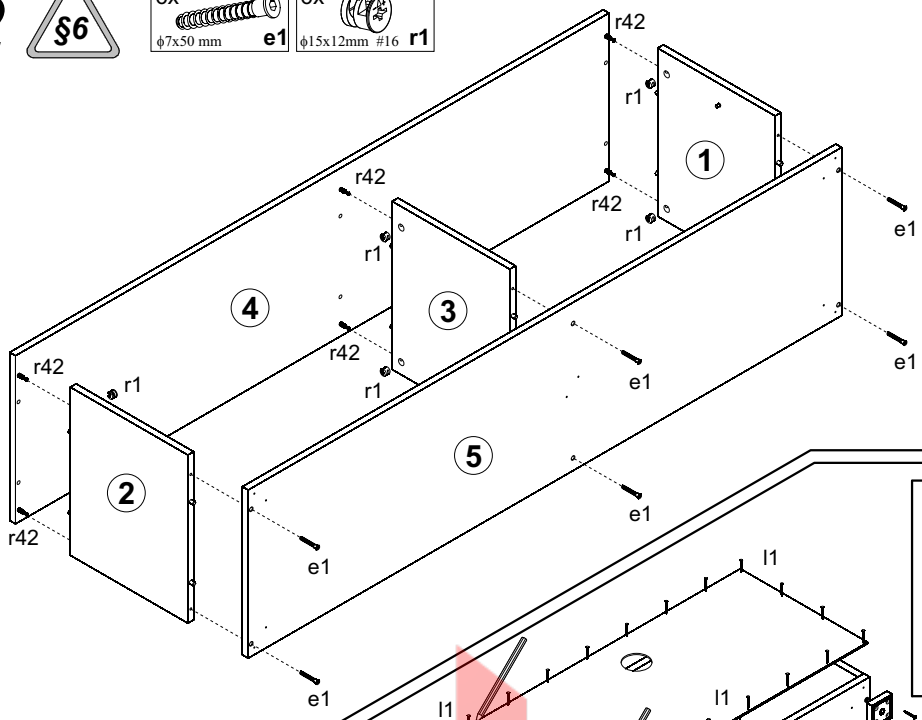
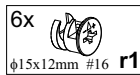
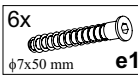

3

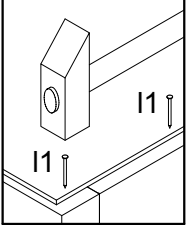
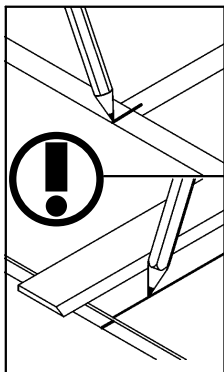
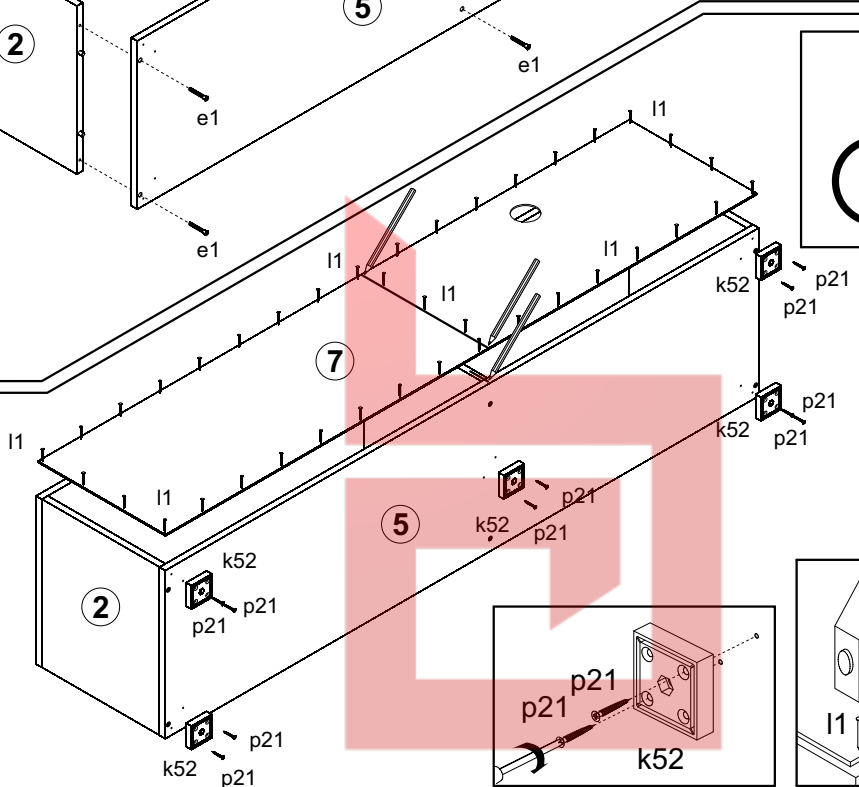
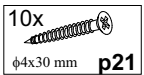
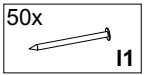
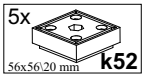

4

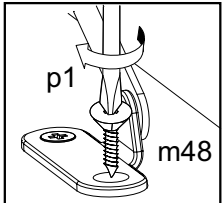
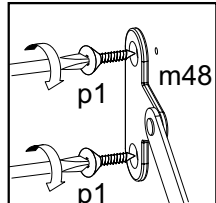
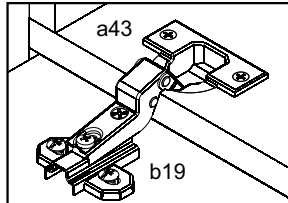
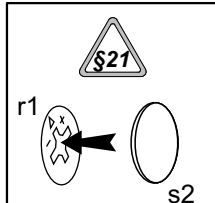
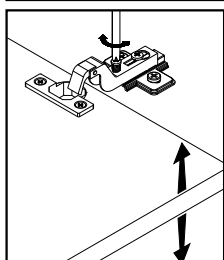
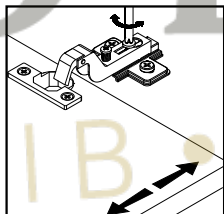
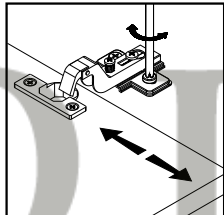
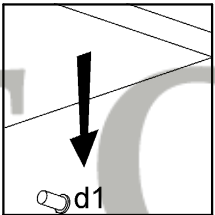
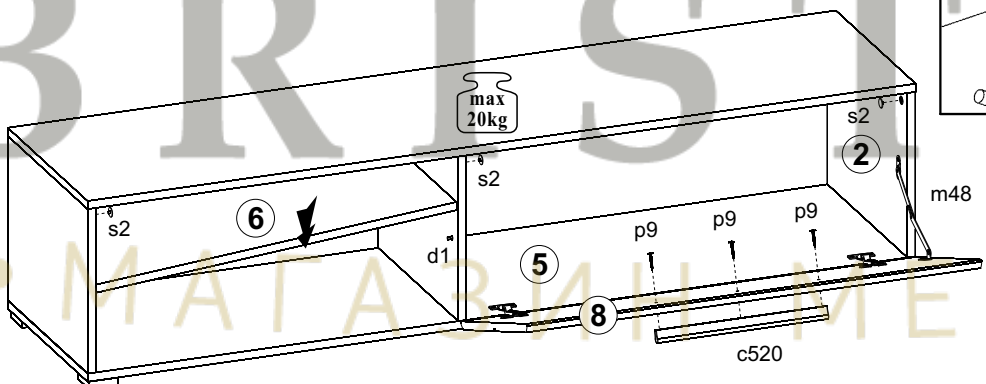
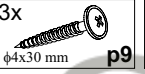
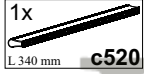

II Пенал

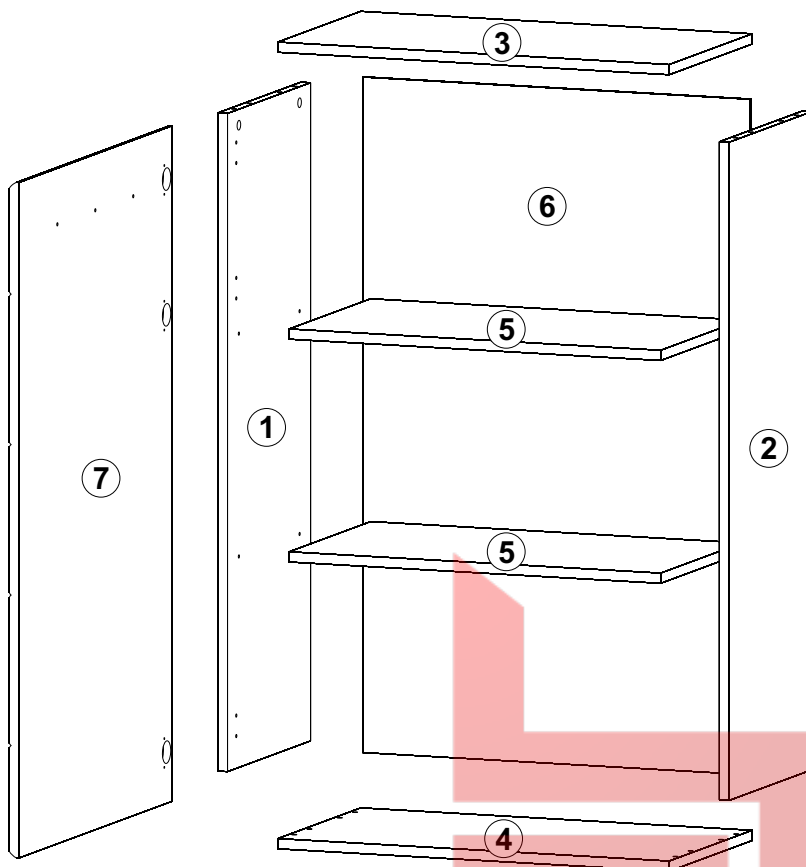
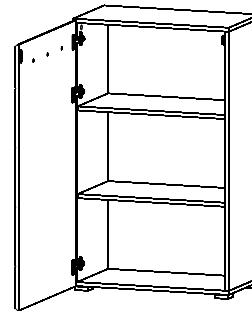



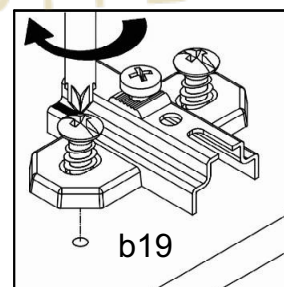
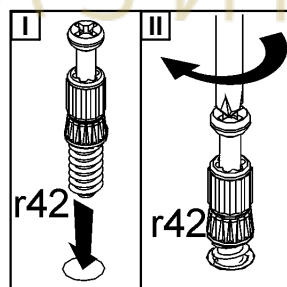
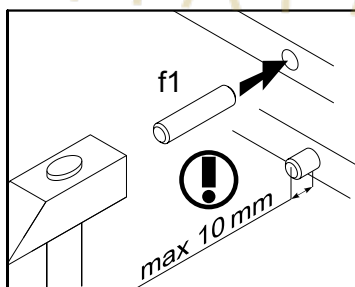
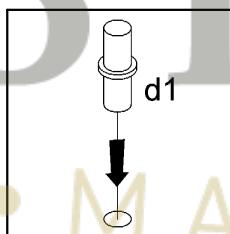
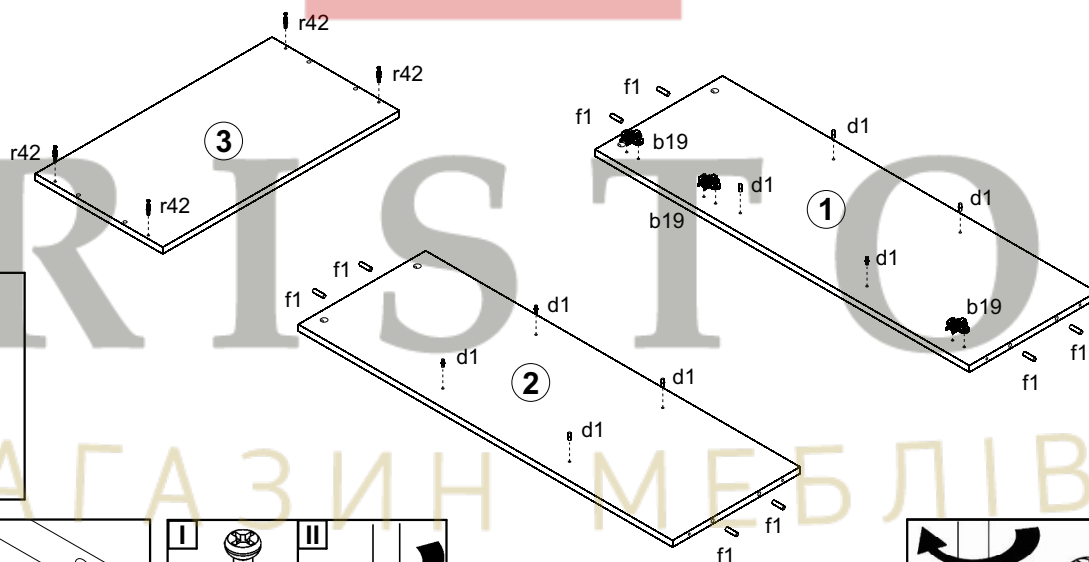
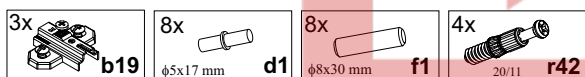

A	B	C	D
1	ML1-101	1028	350 2/3
2	ML1-102	1028	350 2/3
3	ML1-201	650	350 2/3
4	ML1-202	650	350 2/3
5	ML1-304	617	344 2/3
6	ML1-901	1055	644 3/3
7	ML1-001-01	645	1055 3/3

5



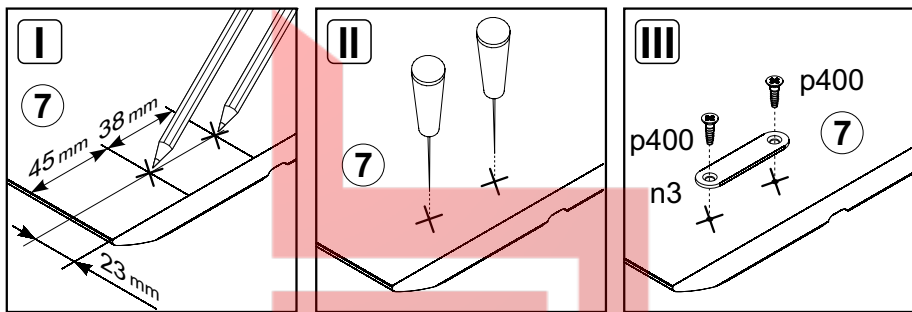
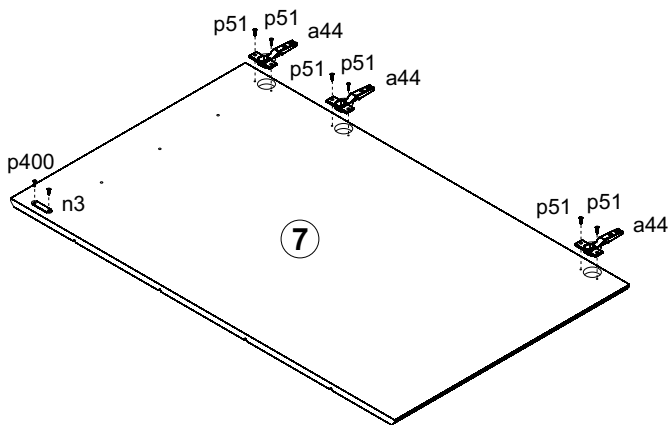
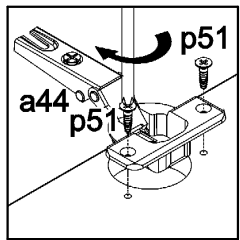

6

- 3x  a44
- 1x  n3
- 6x  p51
- 2x  p400



7



- 4x  e1
- 4x  r1

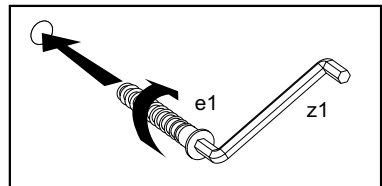
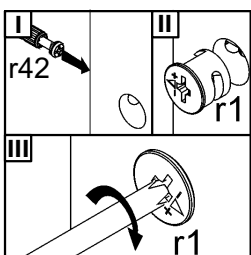
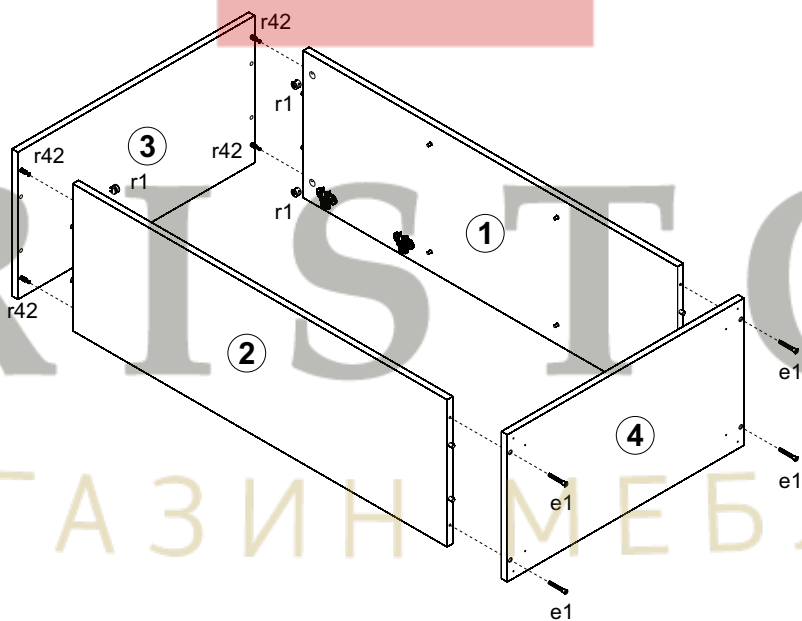

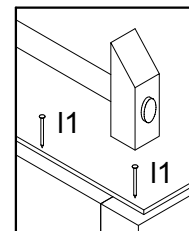
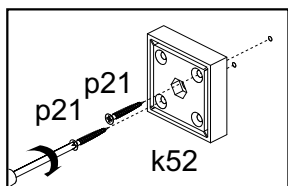
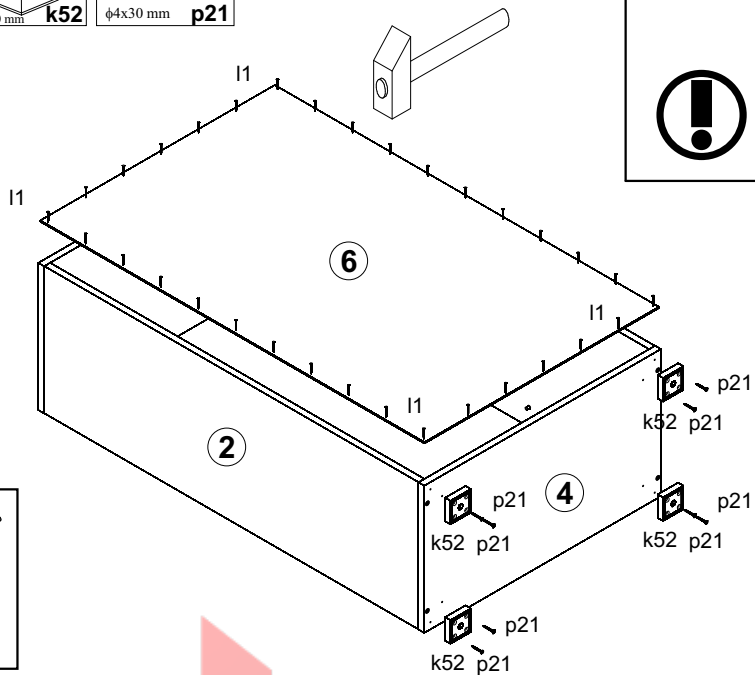
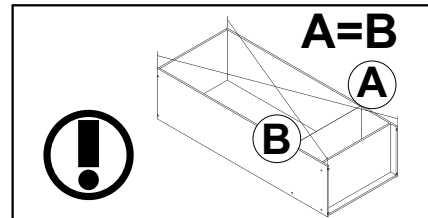
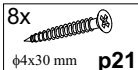
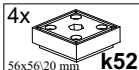
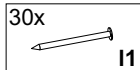
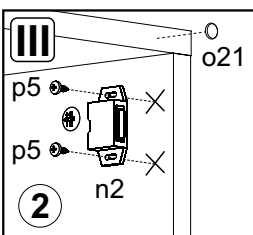
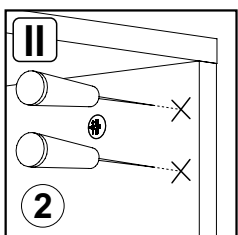
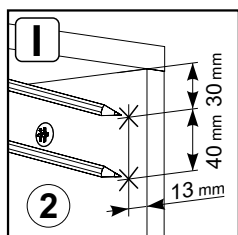
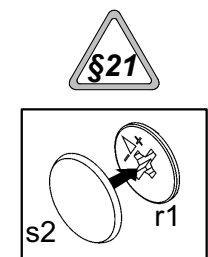
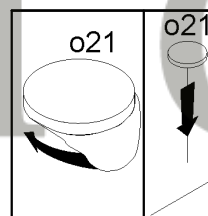
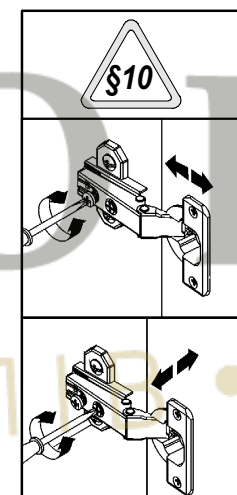
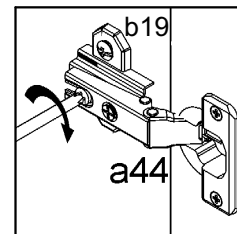
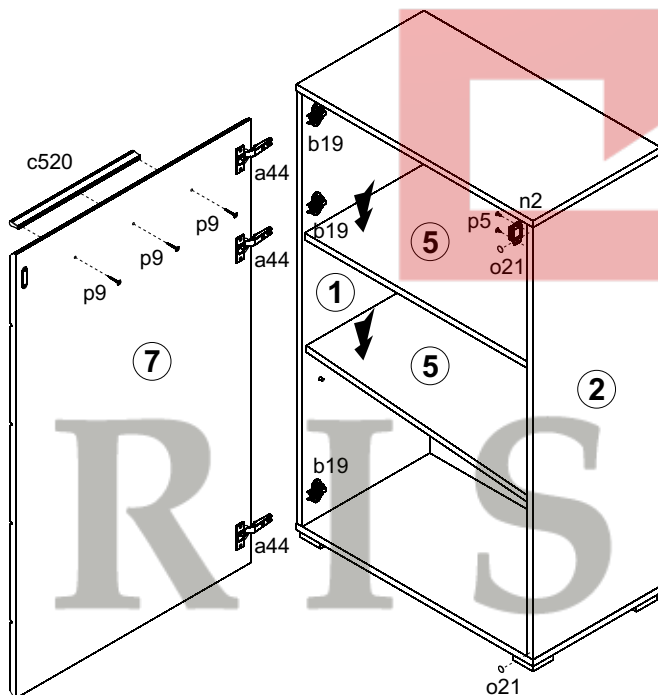
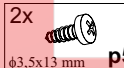
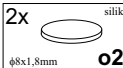
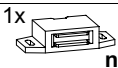
8**9**



Вітрина навісна права / Витрина навесная правая

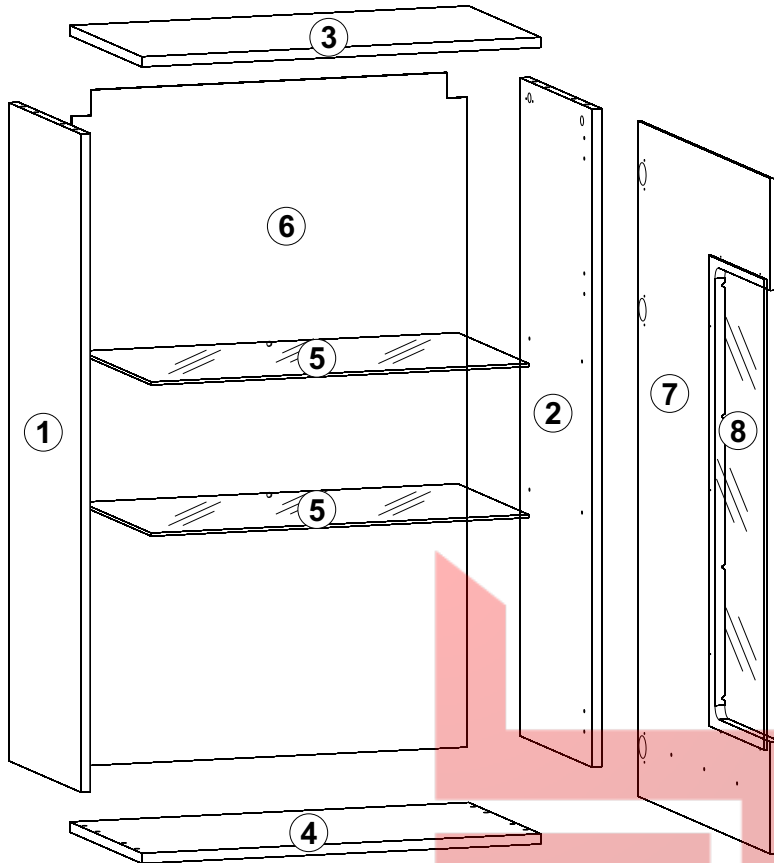
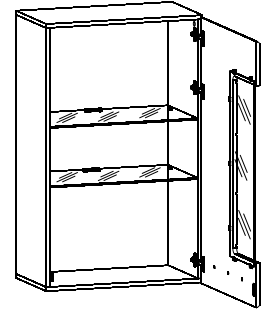



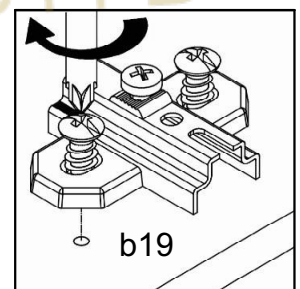
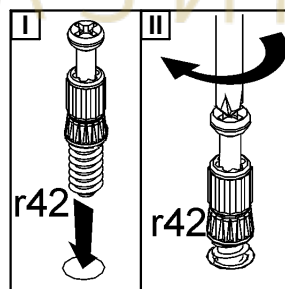
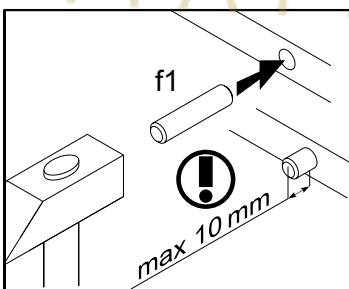
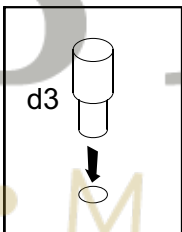
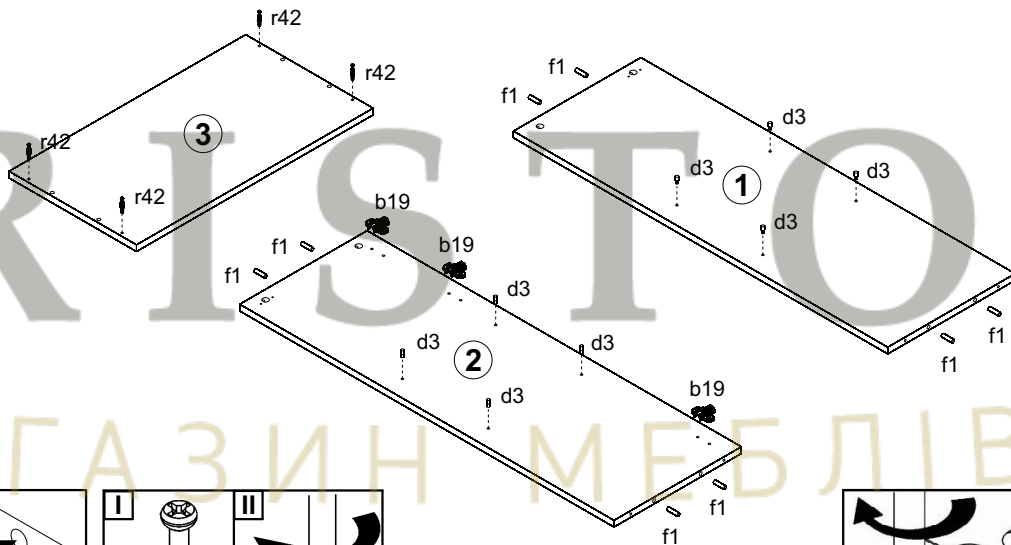
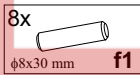
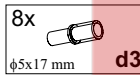

A	B	C	D	
1	ML1-103	1028	350	2/3
2	ML1-104	1028	350	2/3
3	ML1-201	650	350	2/3
4	ML1-203	650	350	2/3
5	ML1-301	615	329	2/3
6	ML1-902	1055	644	3/3
7	ML1-003-01	645	1055	3/3
8	ML1-501	735	270	3/3

10

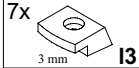
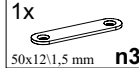

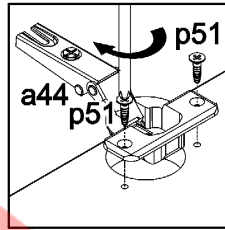
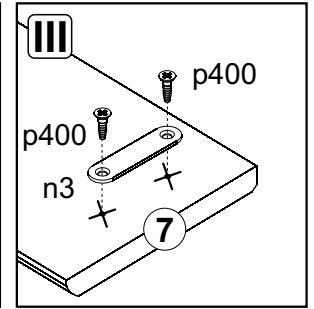
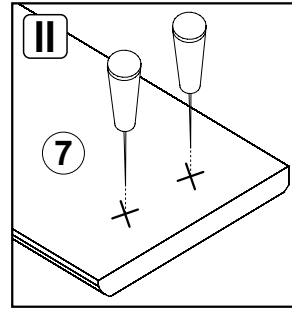
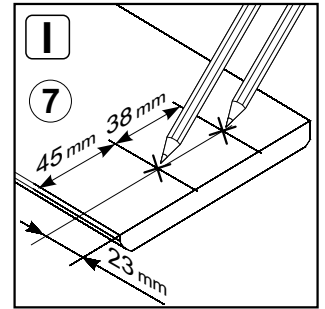
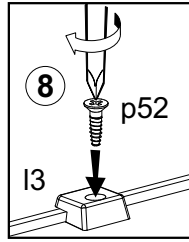
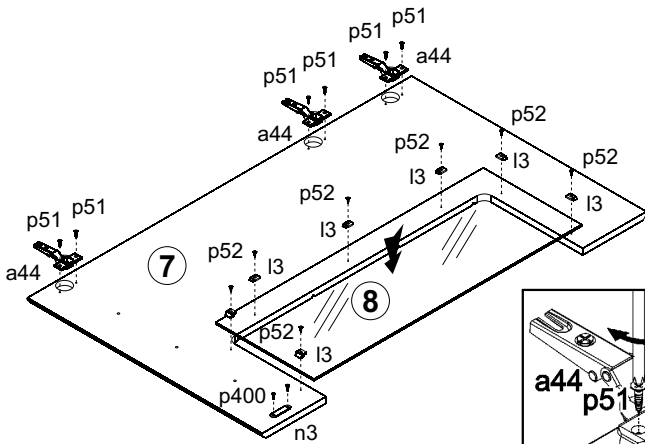

11

- 3x  a44
- 7x  l3
- 1x  n3
- 6x  p51
- 7x  p52
- 2x  p400



12



- 4x  e1
- 4x  r1

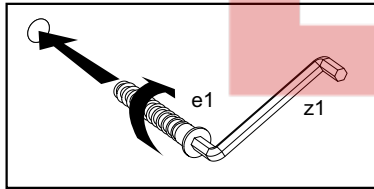
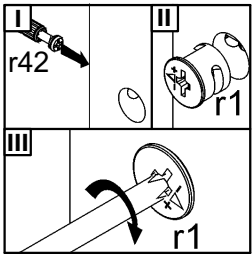
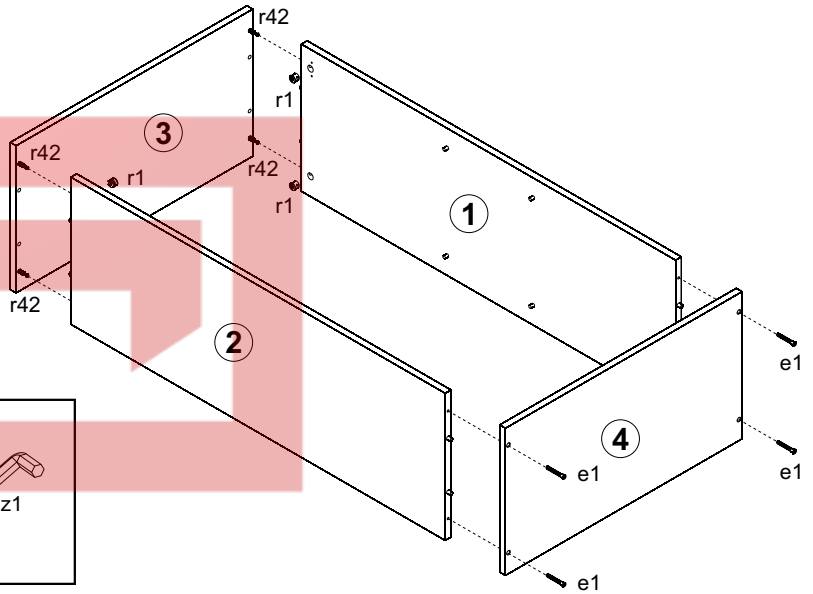

13

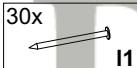
- 30x  l1

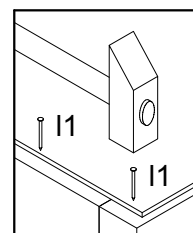
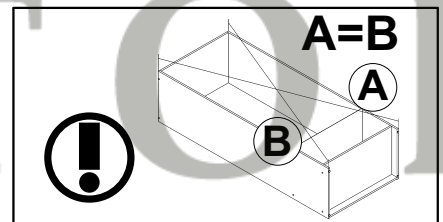
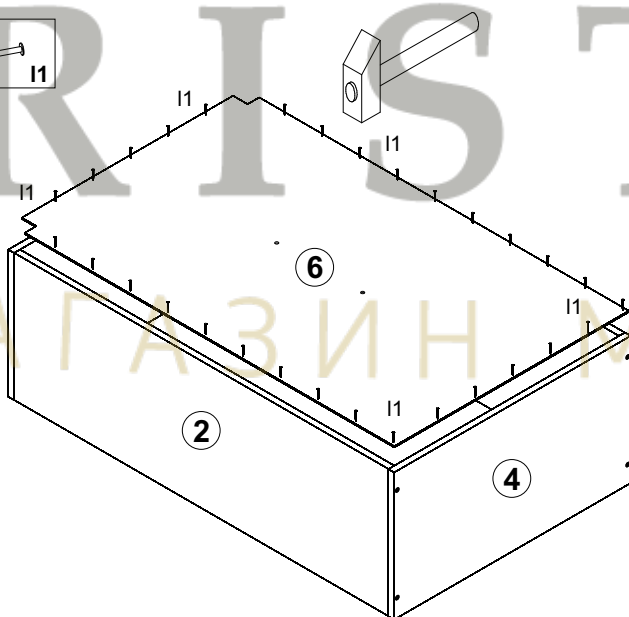

14

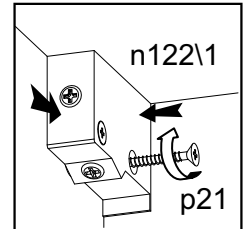
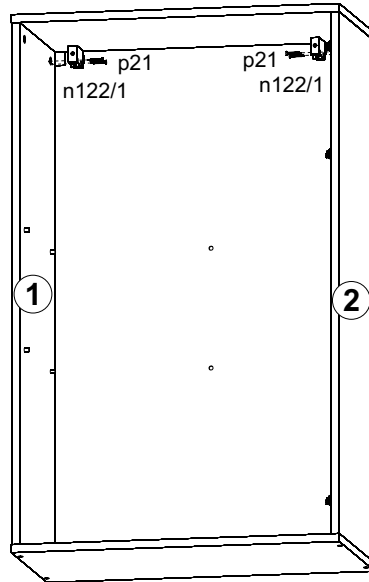
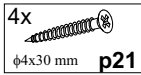

15

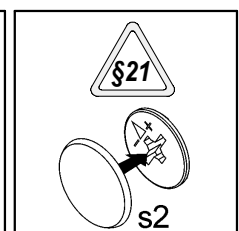
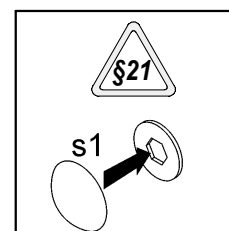
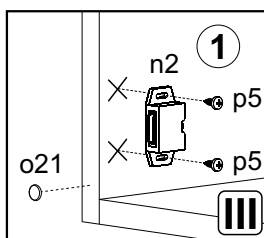
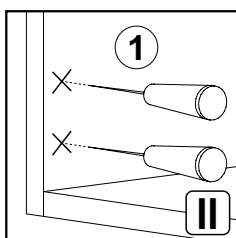
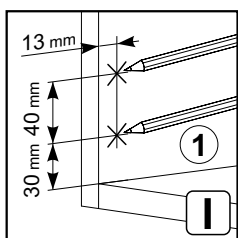
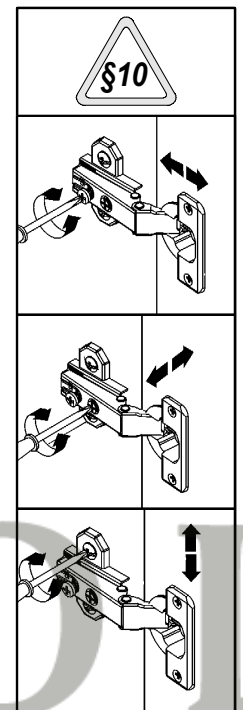
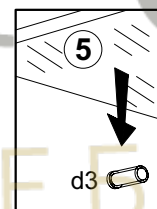
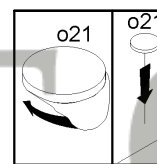
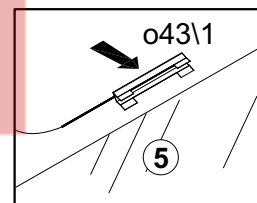
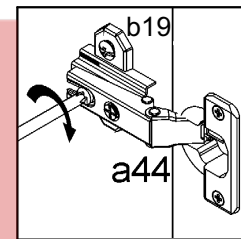
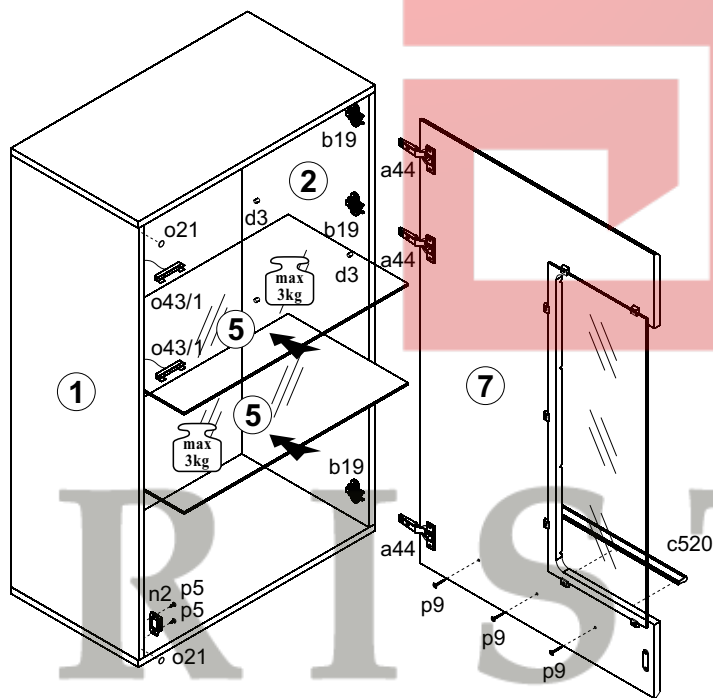
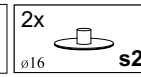
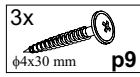
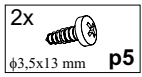
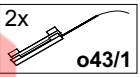
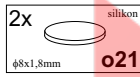
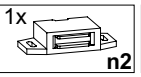
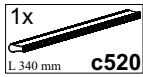

IV Полиця / Полка

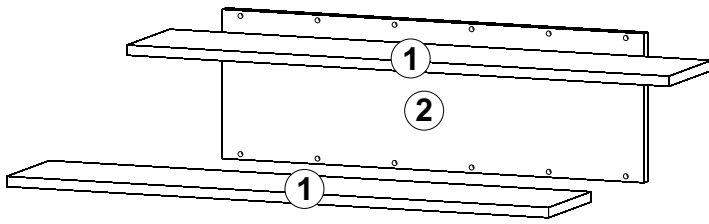
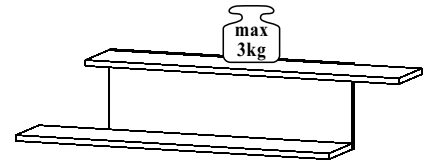

A	B	C	D
1	ML1-303	900	180
2	ML1-401	700	233

16

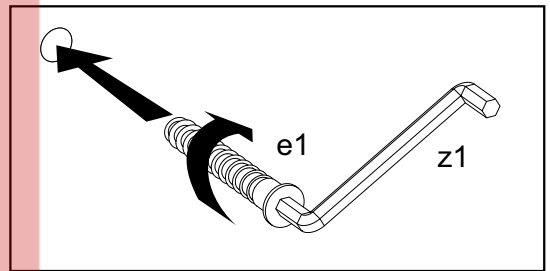
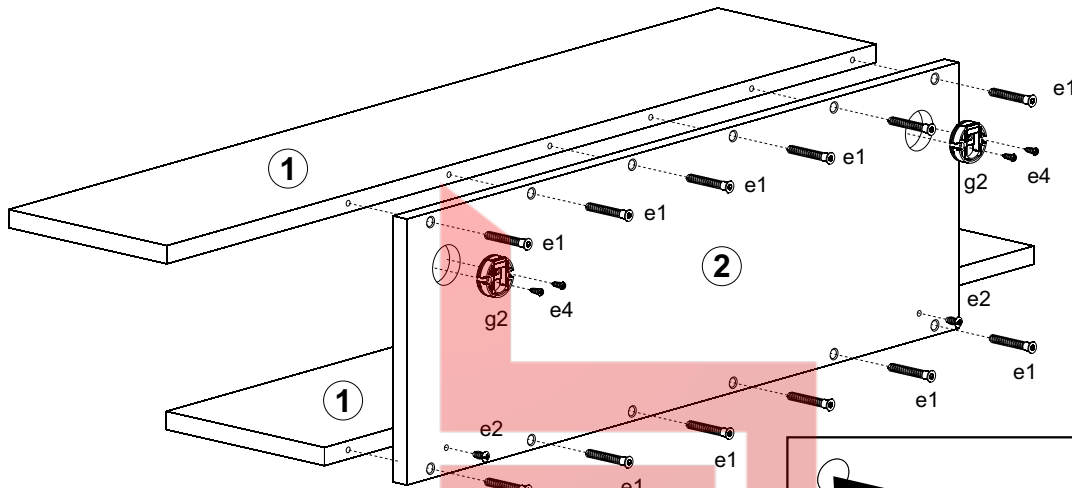
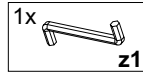
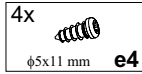
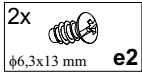
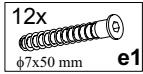

17

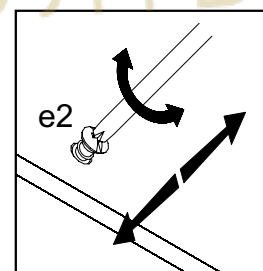
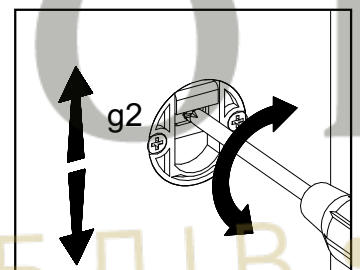
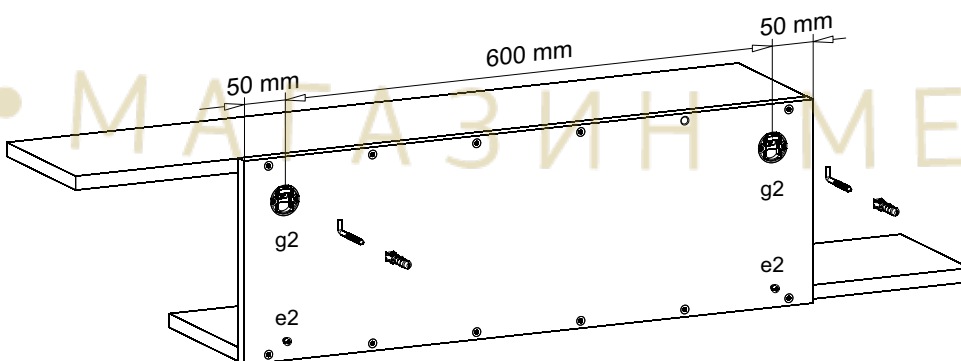
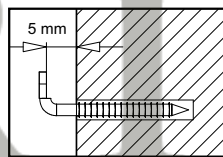
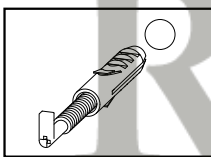
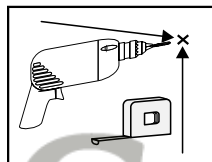

18

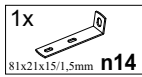
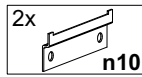

25 mm 64 mm

64 mm 25 mm

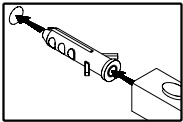
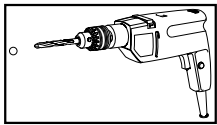
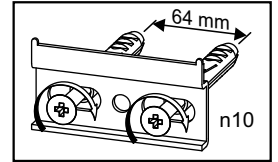
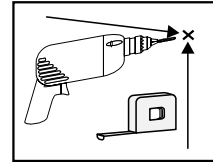

n14

