

A	B	C		D
1	NT1-765	1660	842	2/4
2	NT1-767	1660	387	2/4
3	NT1-014	1523	386	1/4
4	NT1-125	1603	200	3/4
5	NT1-126	2000	250	3/4
6	NT1-523	1694	80	3/4
7	NT1-524	1694	80	3/4
8	NT1-521	386	68	4/4
9	NT1-522	486	68	4/4
10	NT1-570	350	92	4/4

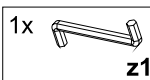

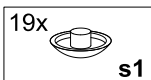

3

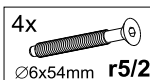
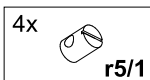
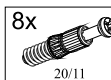
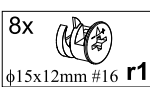
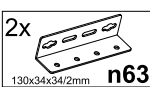
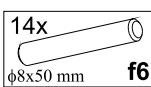
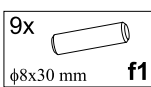
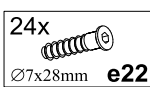
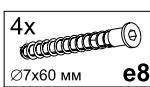
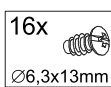
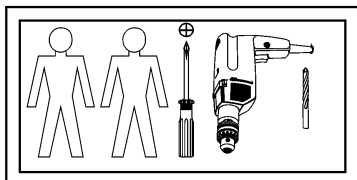
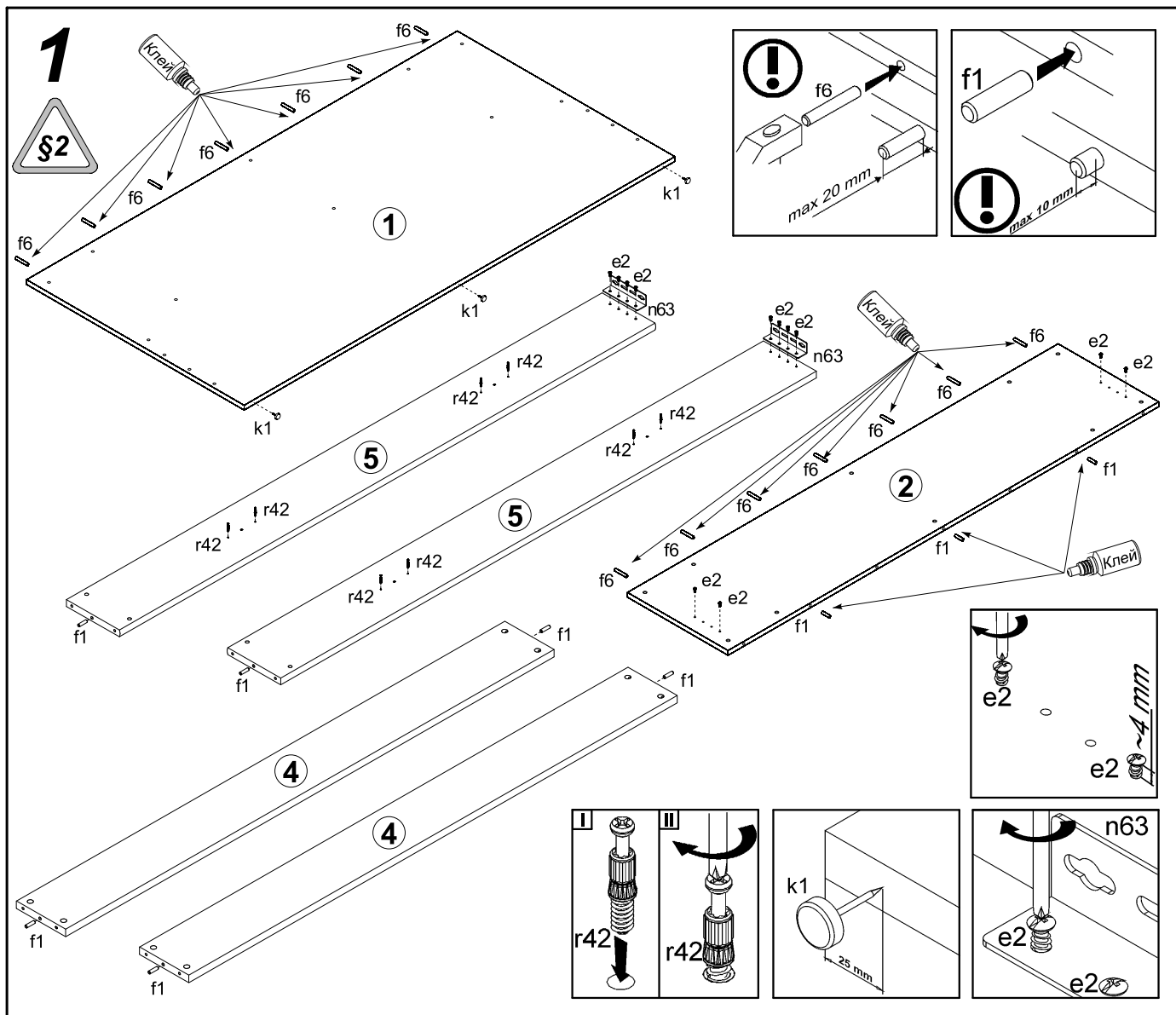
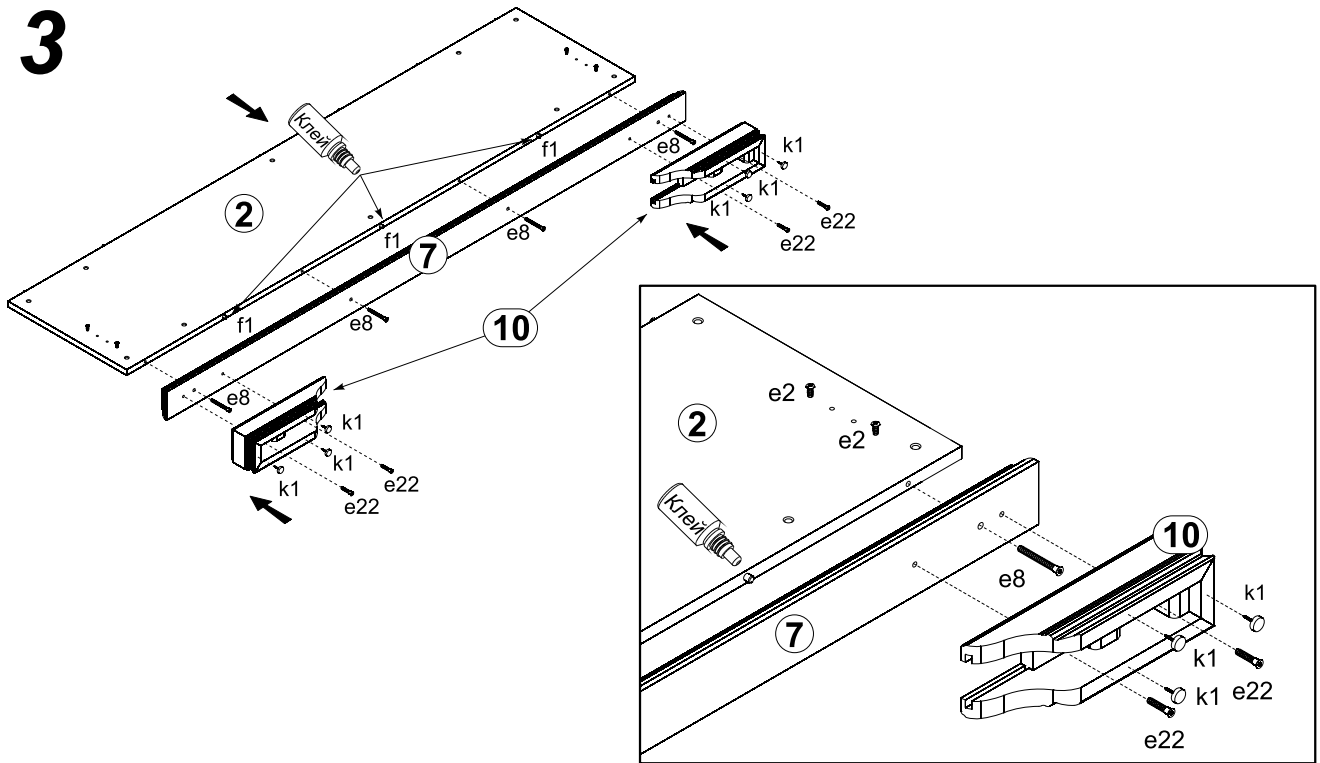

4

