

# КОЕН

Пенал REG1D2S

A	B	C	D	
1	S136-003	446	185	3/4
1A	S136-003A	446	185	3/4
2	S136-001	1458	446	4/4
2A	S136-001B	1458	446	4/4
3	S136-113	1983	371	1/4
4	S136-114	1983	371	1/4
5	S136-115	408	371	1/4
6	S136-116	408	371	1/4
7	S136-204	580	371	1/4
8	S136-302	547	371	1/4
9	S136-404	547	68	1/4
10	S136-405	453	60	1/4
11	S136-406	451	50	1/4
12	S136-334	547	371	1/4
13	S136-571	2000	65	2/4
14	S136-572	2000	65	2/4
15	S136-576	581	65	2/4
16	S136-904	415	348	1/4
17	S136-908	1925	287	1/4
18	S136-511	350	120	1/4
19	S136-512	350	120	1/4
20	S136-5557	404	120	1/4
21	LH-1898	1898	14	1/4

→ Фасад ДСП  
→ Фасад МДФ  
→ Фасад ДСП  
→ Фасад МДФ

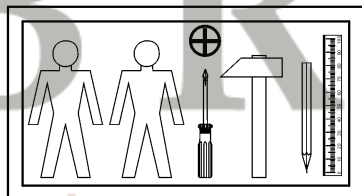
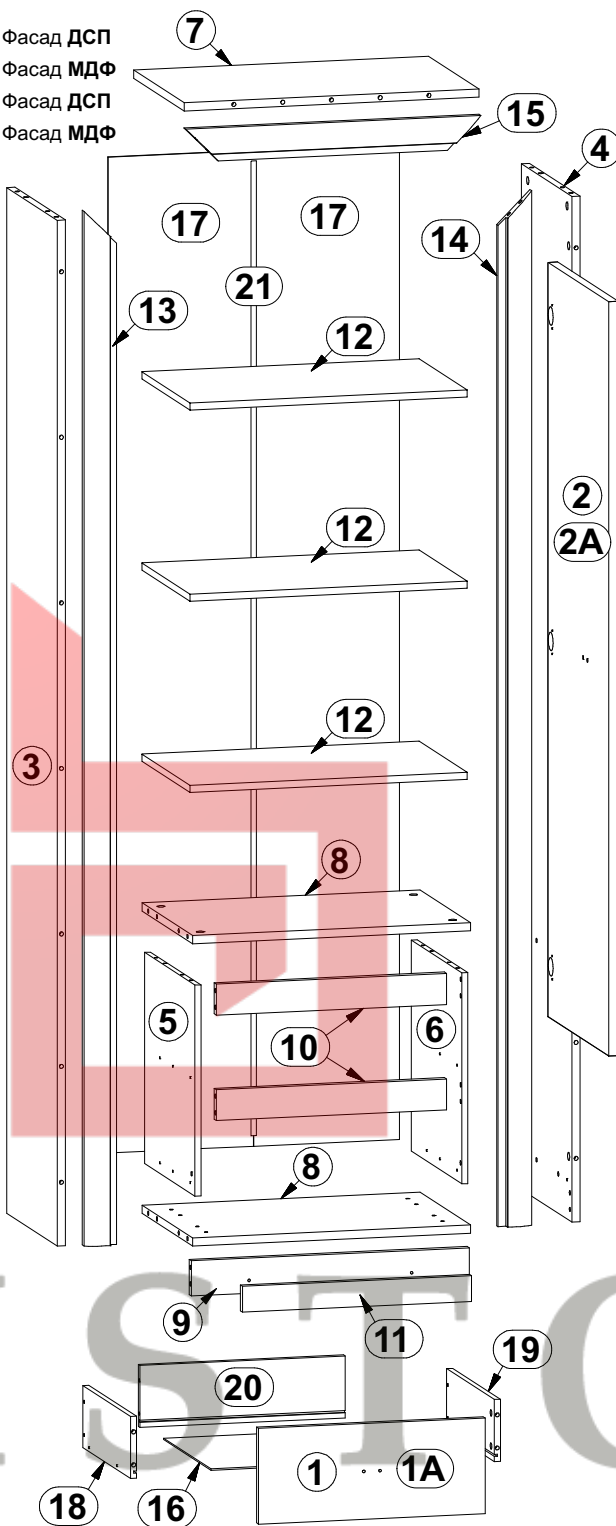

3x  a99	3x  b43	3x  c317	12x  d1 φ5x17 mm	6x  e2 φ6,3x13 mm	6x  p51 φ3,5x15 mm	12x  e3 φ6x13 mm	8x  e32 φ5x50 mm	34x  f1 φ8x30 mm	
16x  f9 φ6x30 mm	6x  j30 M4x22 mm	4x  k1	60x  l1	1x  n26/1	1x  p38 φ3,5x16 mm	8x  p54 φ3x12 mm	2x  p94 φ4x28 mm	27x  r1 φ15x12mm #16	
2x  r10	8x  r15 φ12x10,5mm #12	31x  r42 20/11	8x  s2 φ16	2x  w45/CL 350 mm	2x  w45/CR 350 mm	2x  w45/DL 350 mm	2x  w45/DR 350 mm		
								3x  a63/1 h=3mm	Для фас. МДФ

**1**  §2

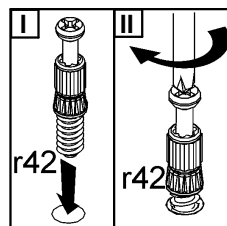
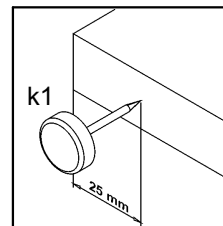
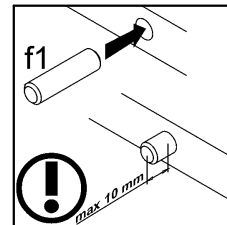
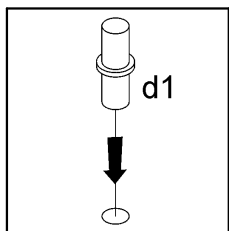
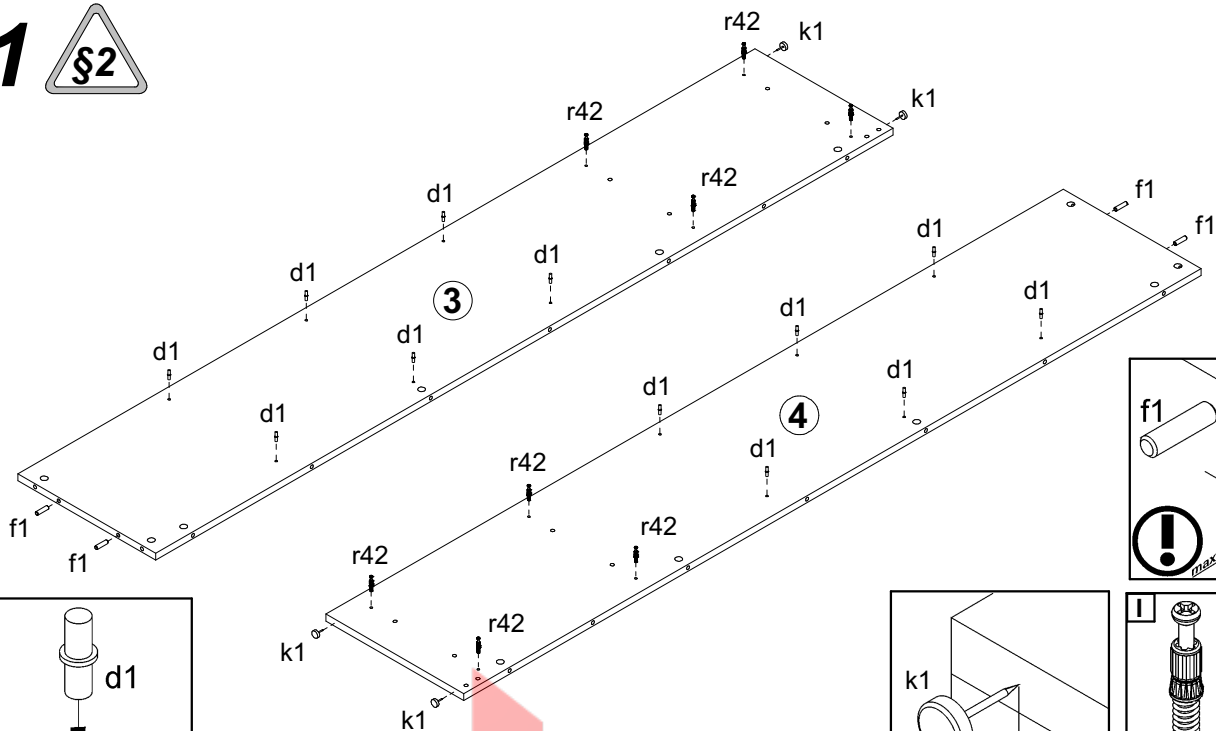

**2**  §6

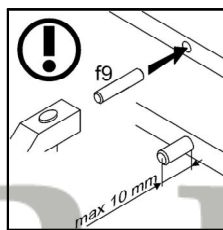
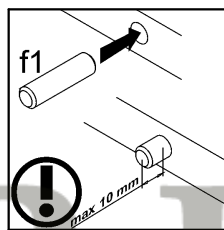
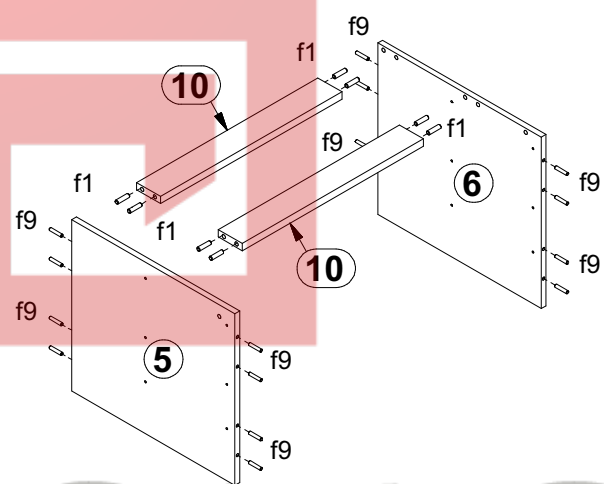

**3**

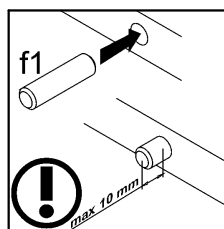
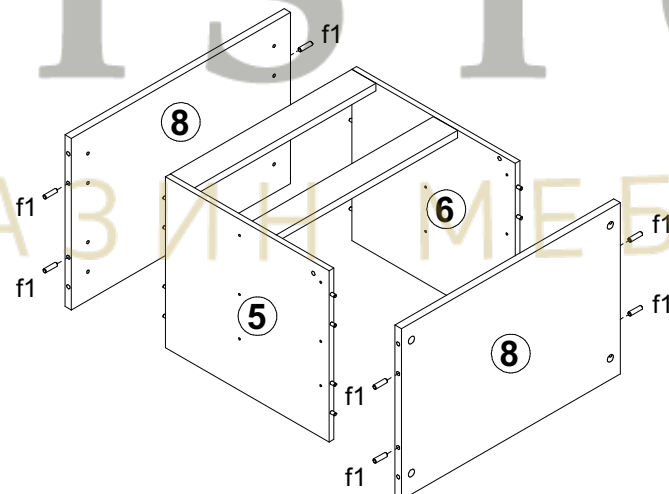

# 4

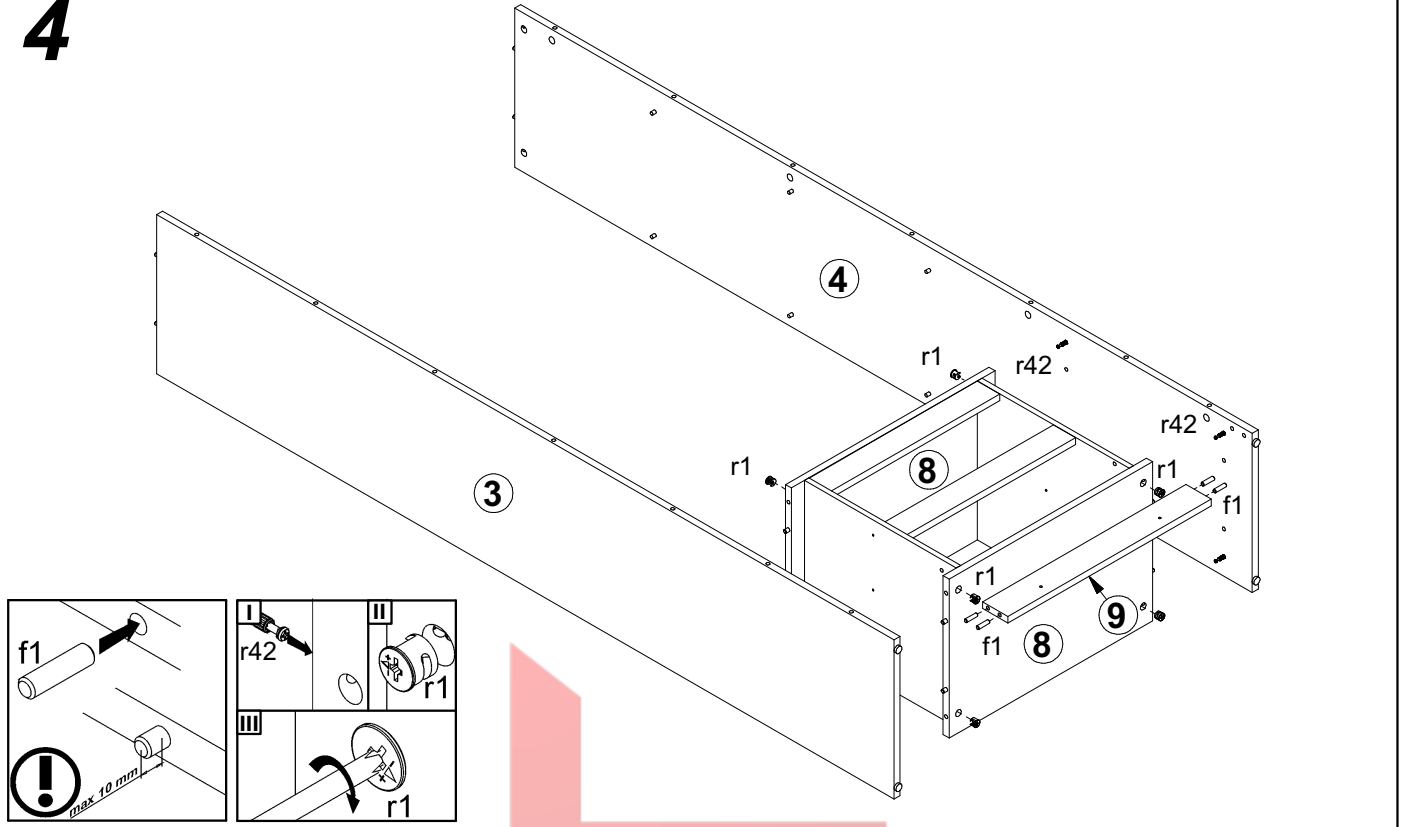

# 5

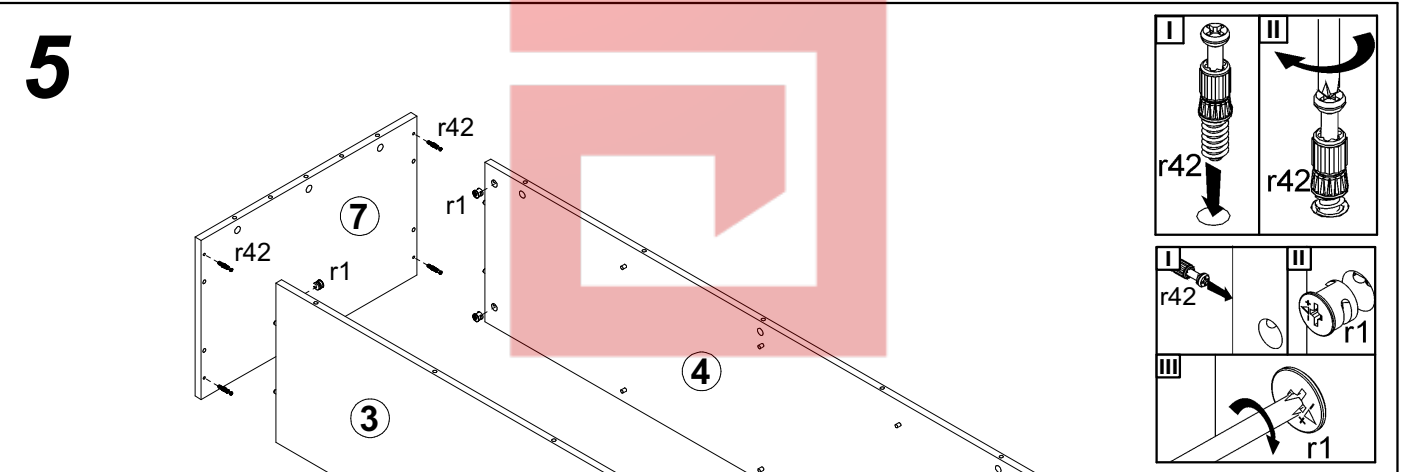

# 6

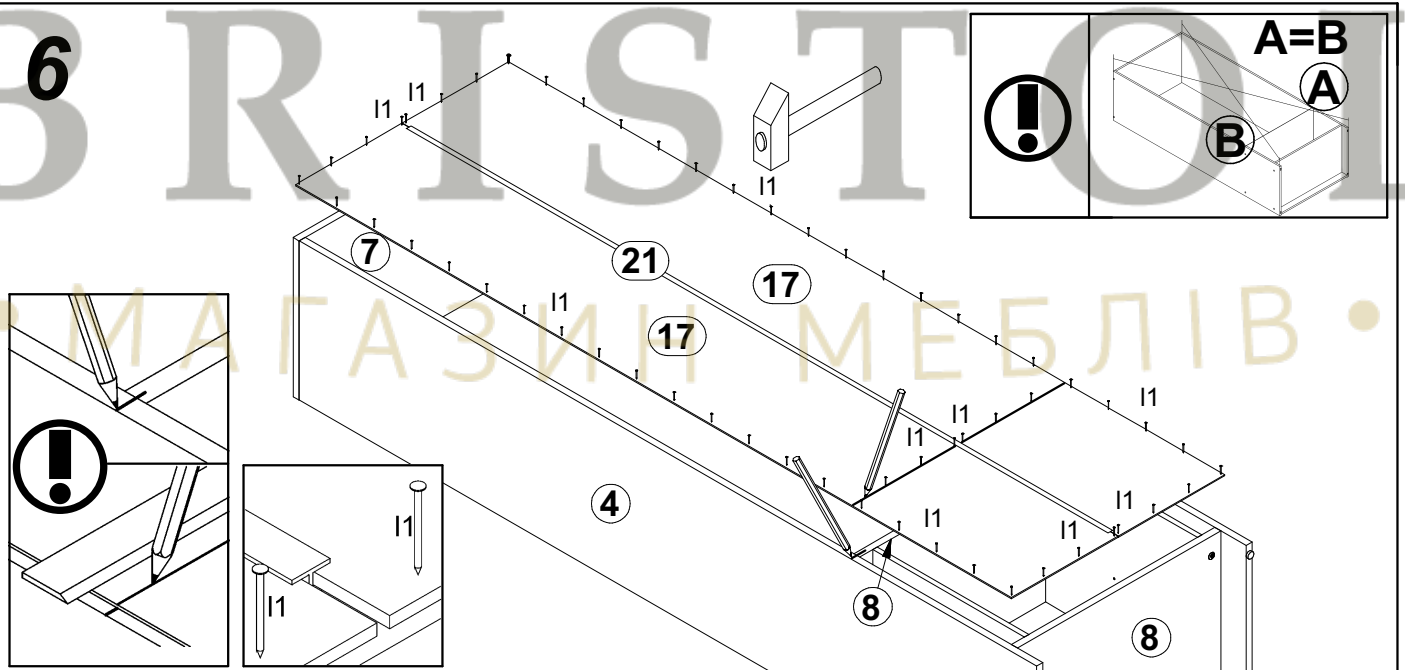

# 7

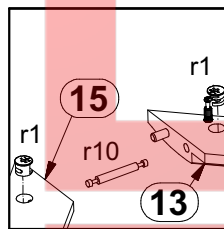
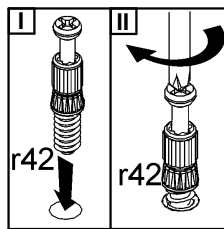
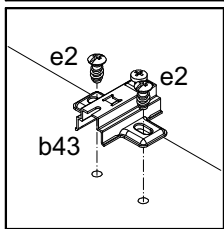
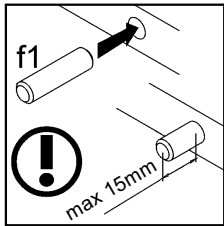
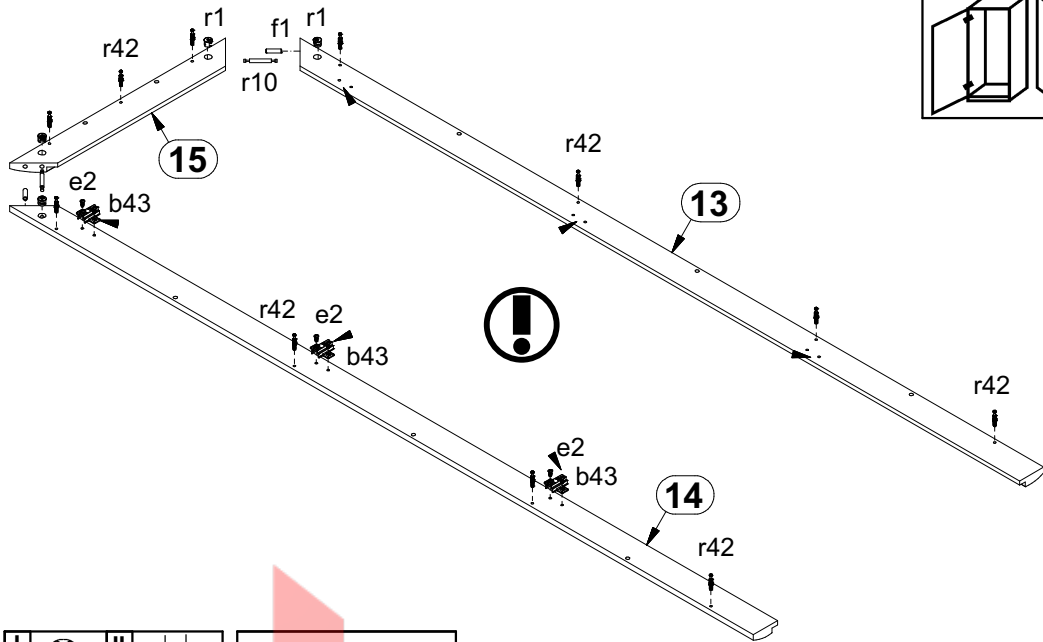
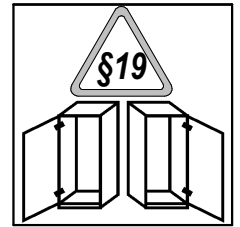

# 8

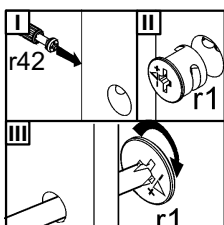
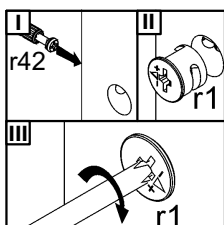
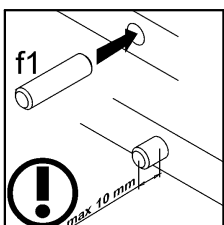
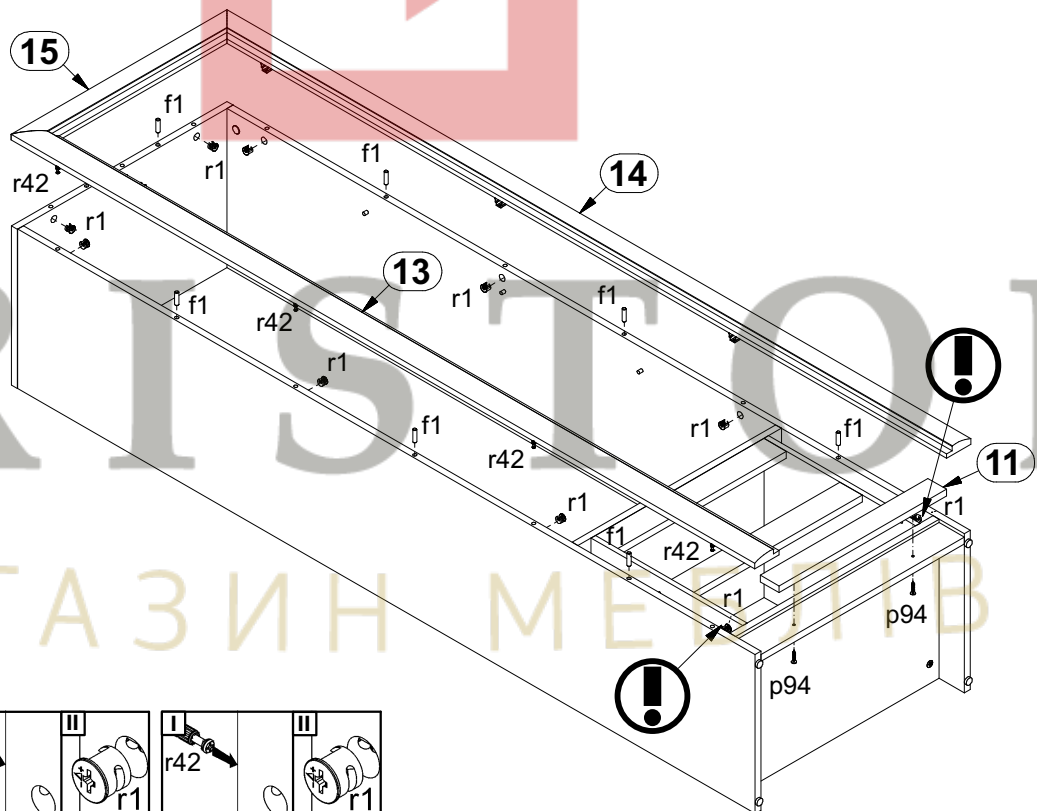

9

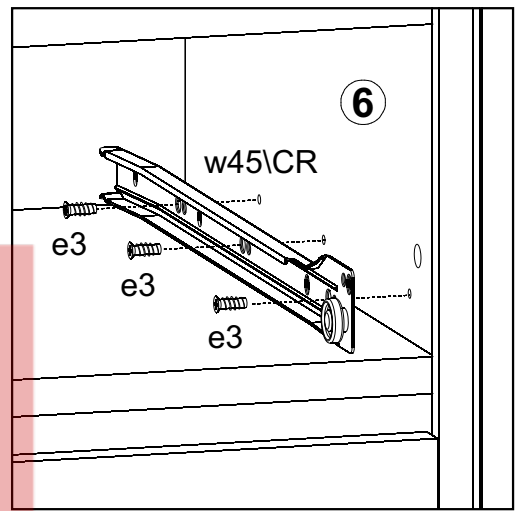
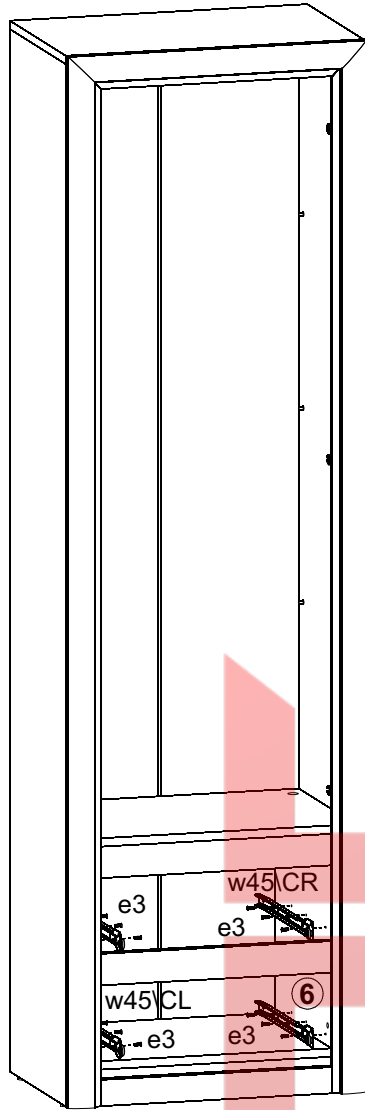

10

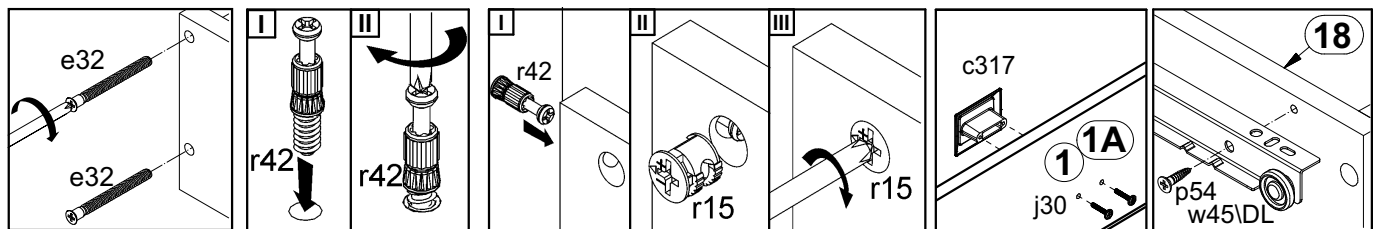
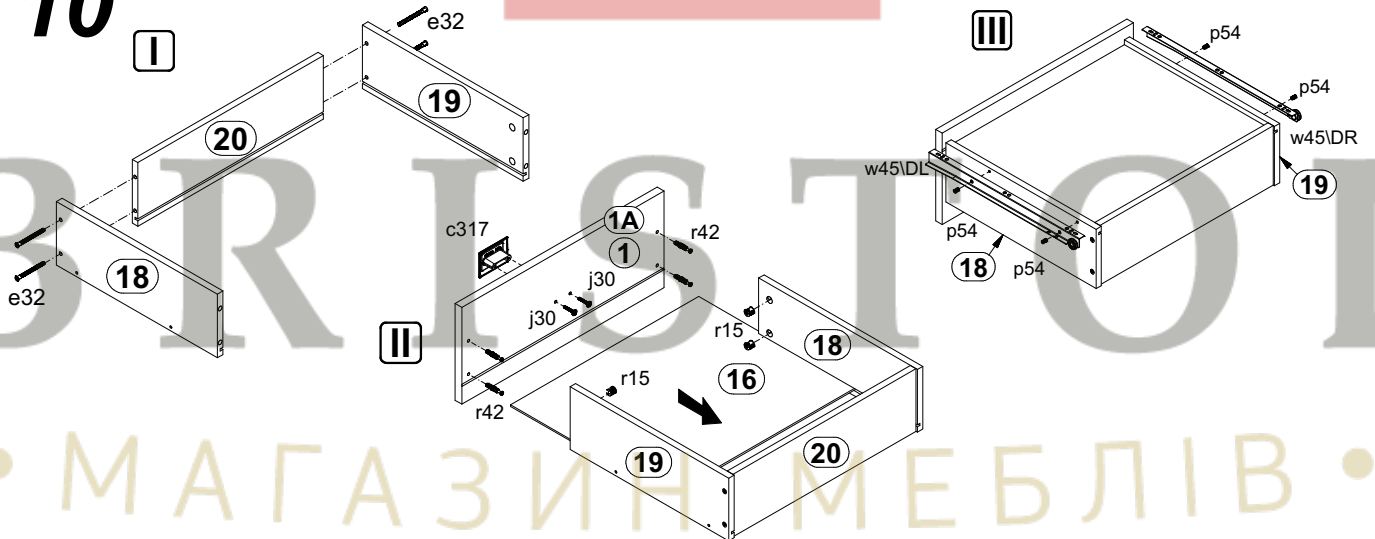

# 11

## Фасад ДСП

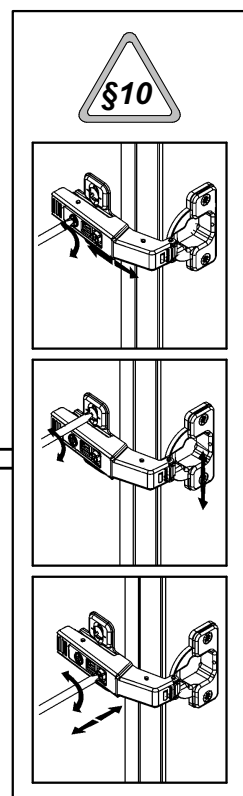
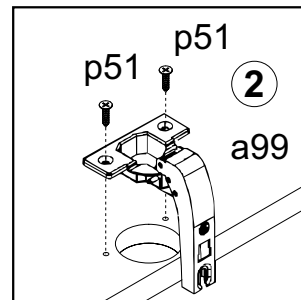
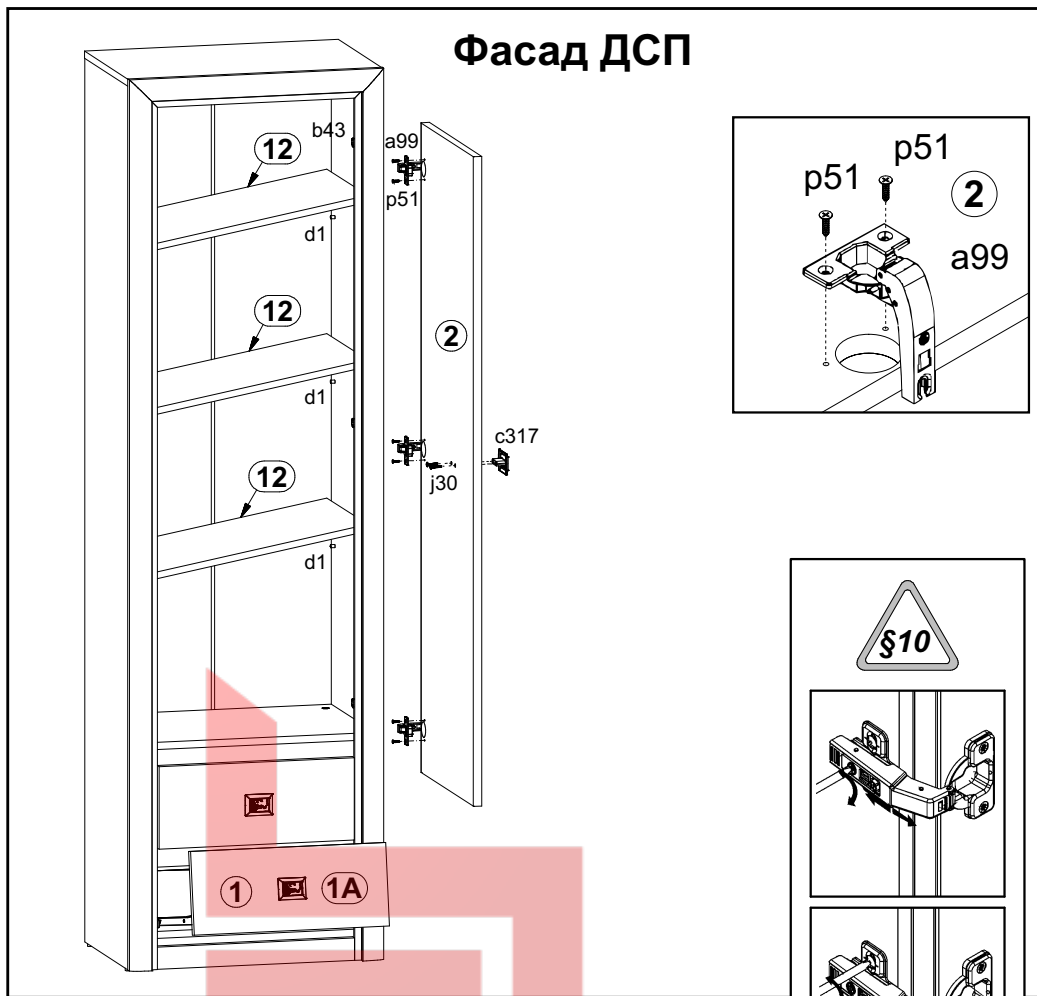
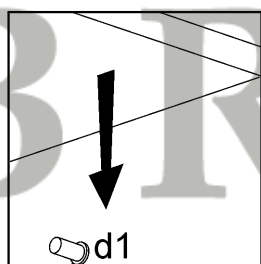
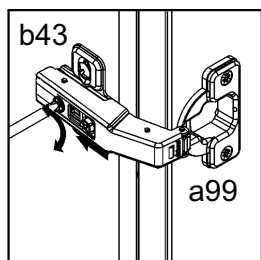
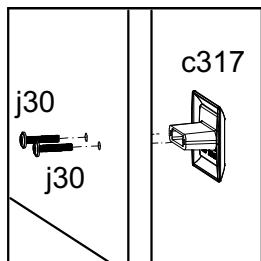
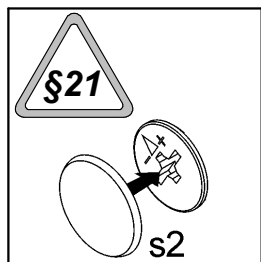
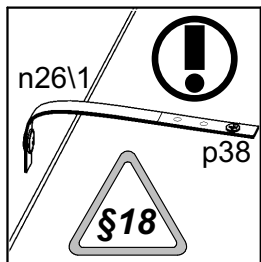

## Фасад МДФ

