

RAFLO

S126-REG1W/19/6 P

A	B	C	D
1	S126-138	1902	329
2	S126-201	590	351
3	S126-302	557	315
4	S126-319	557	315
5	S126-451	567	562
6	S126-559	229	522
7	S126-580	1085	80
8	S126-581	835	80
9	S126-582	623	80
10	S126-743	462	130
11	S126-744	834	329
12	S126-745	606	329
13	S126-9908	561	567
14	S126-9909	761	567
15	qa82\1		1/2

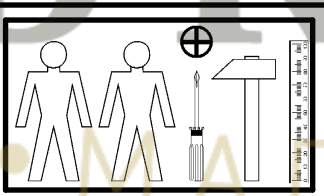
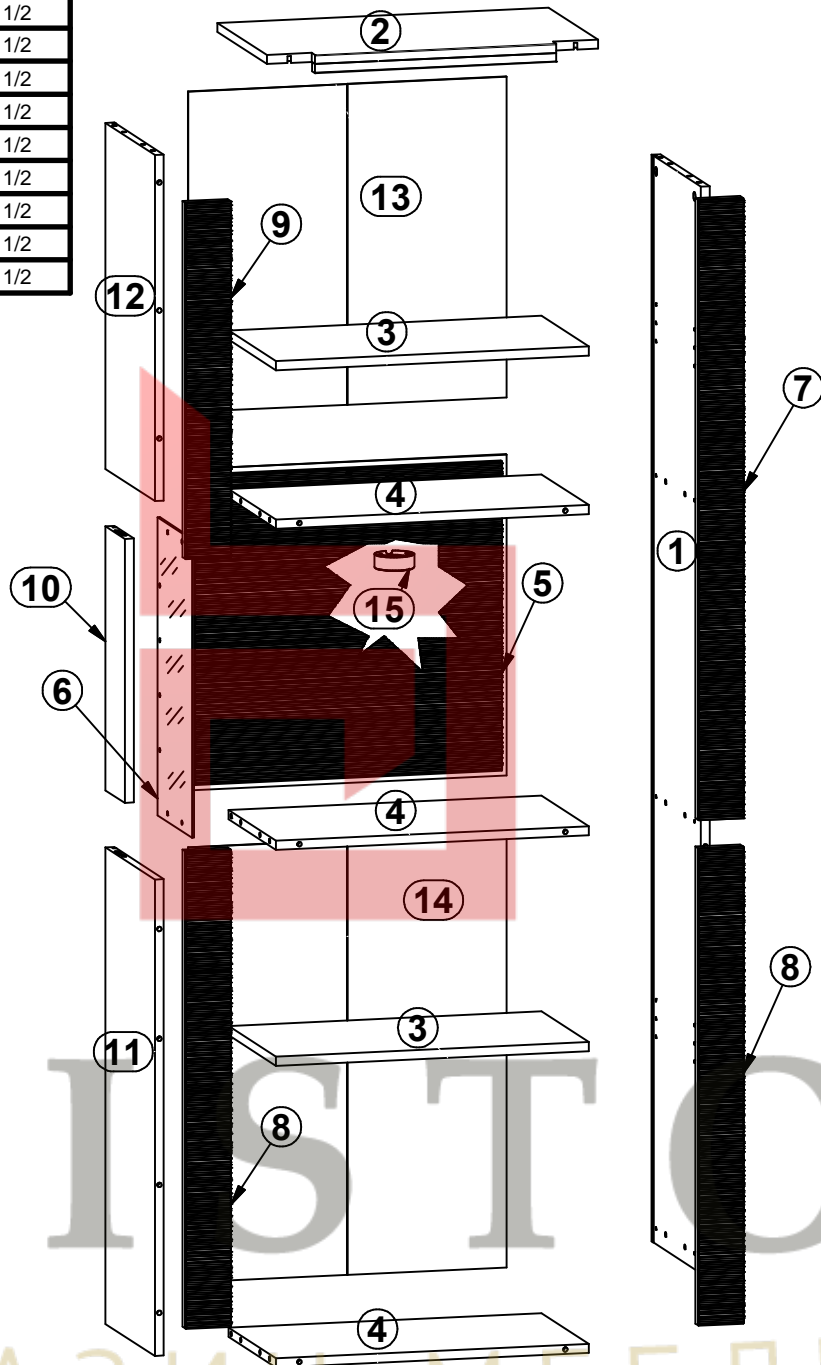
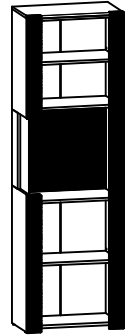

4x a56	4x b41	1x c315	8x $\phi 8 \times 17$ mm d1	24x $\phi 8 \times 30$ mm f1	4x $\phi 8 \times 50$ mm f6	4x k1	18x l1	14x l2
6x 28x13x3,5\1 mm n108	16x o1	1x o48\1	1x o48\2	2x p114	16x $\phi 3,5 \times 16$ mm p38	8x $\phi 3,5 \times 15$ mm p51	2x $\phi 3 \times 12$ mm p54	6x $\phi 2,9 \times 16$ mm p55
39x $\phi 1,5 \times 12$ mm #16 r1	4x r10	2x $\phi 20 \times 12$ mm #16 r36	2x $\phi 7,7 \times 8$ r37	31x r42	21x $\phi 16$ s2	1x n26\1	1x $\phi 3,5 \times 16$ mm p38	2x $\phi 11 \times 5$ mm s43

1

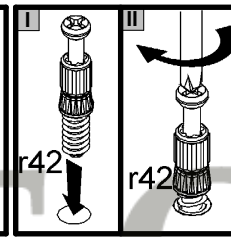
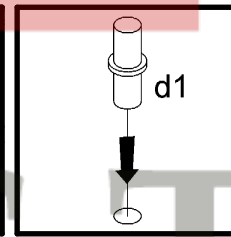
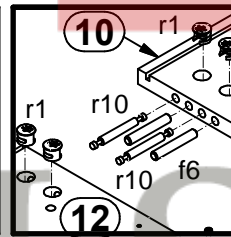
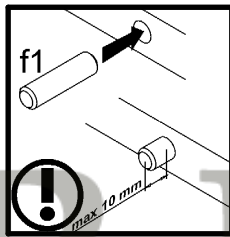
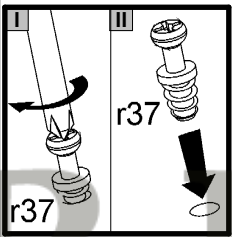
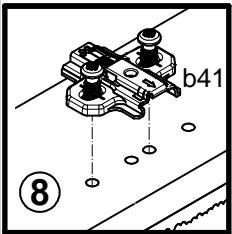
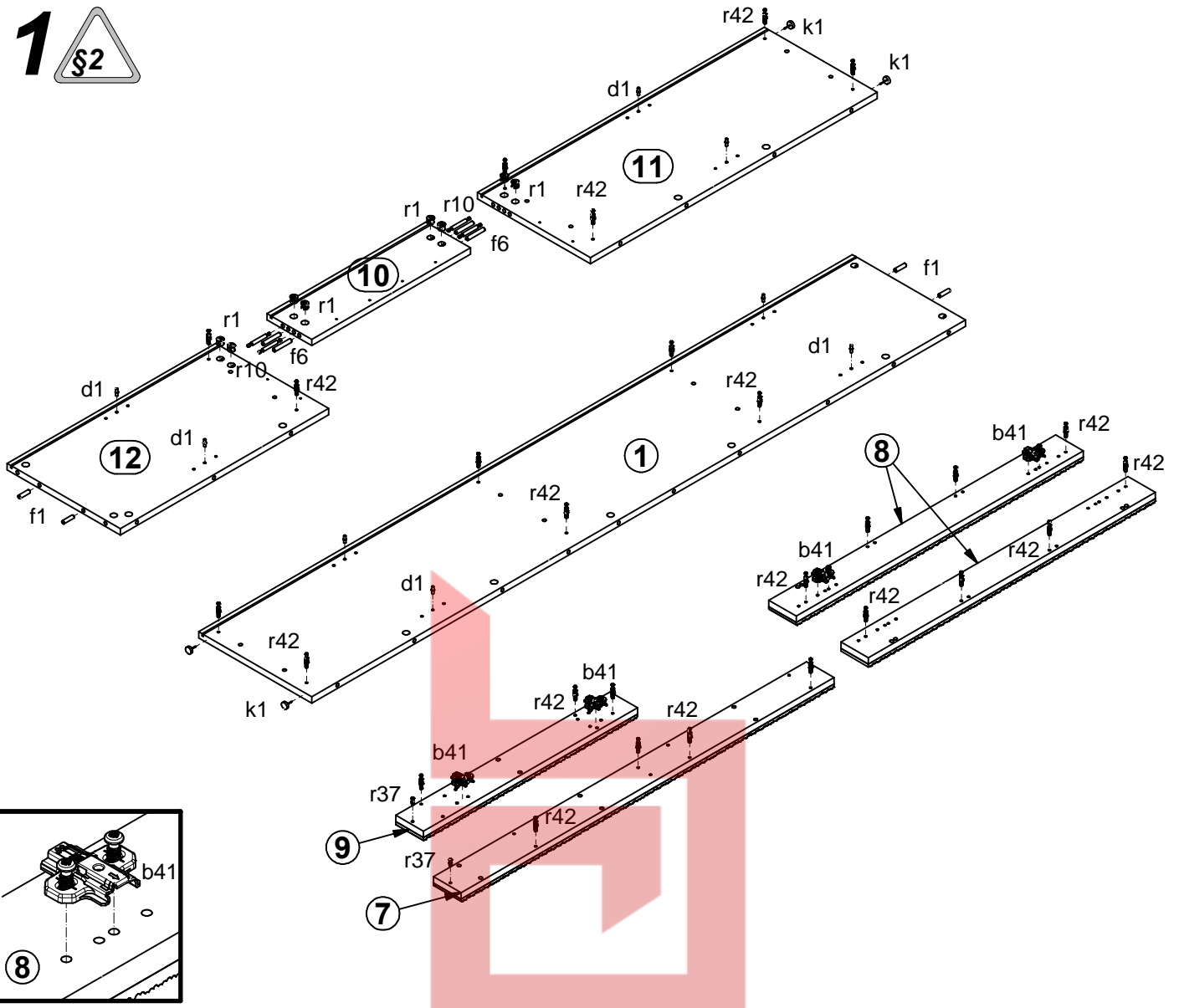

2

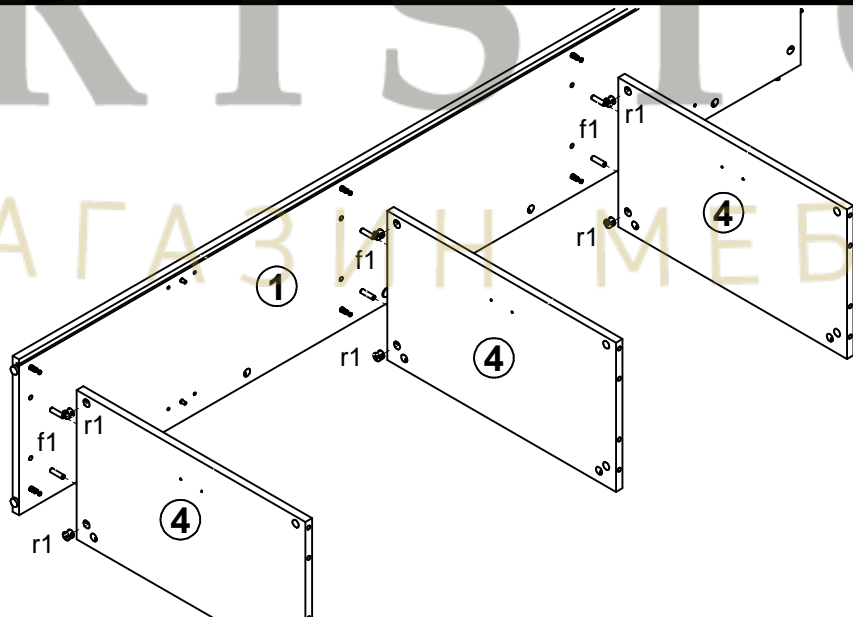

3

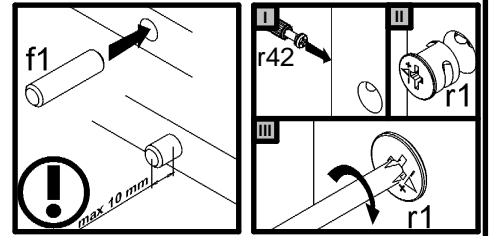
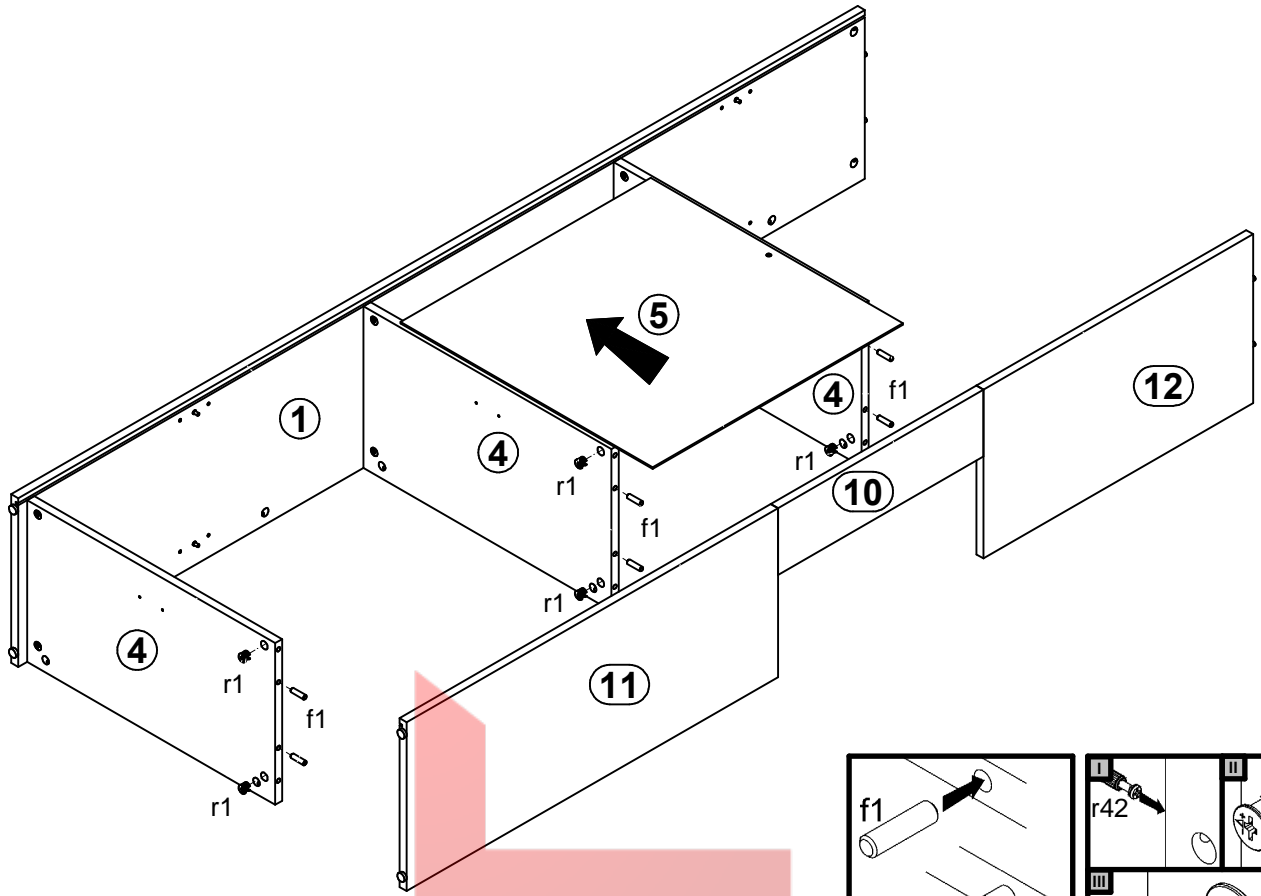

4

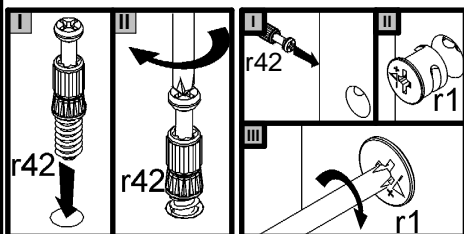
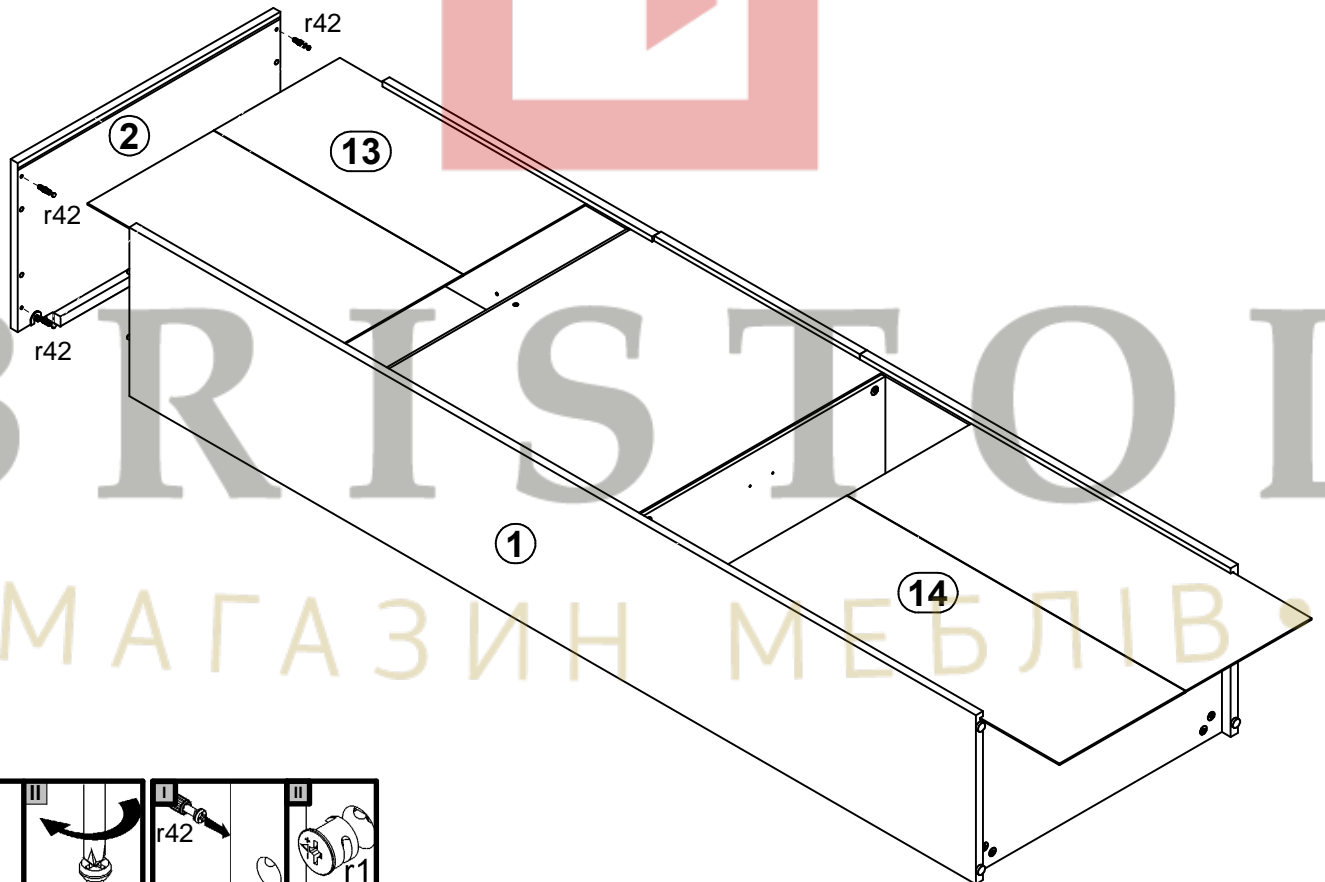

5

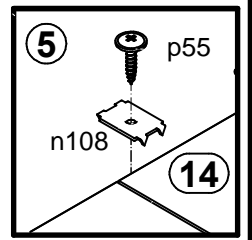
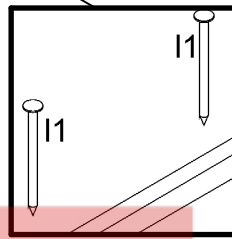
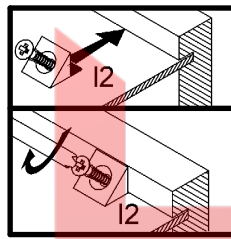
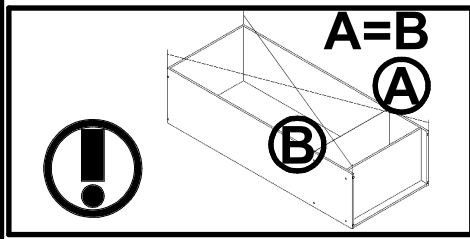
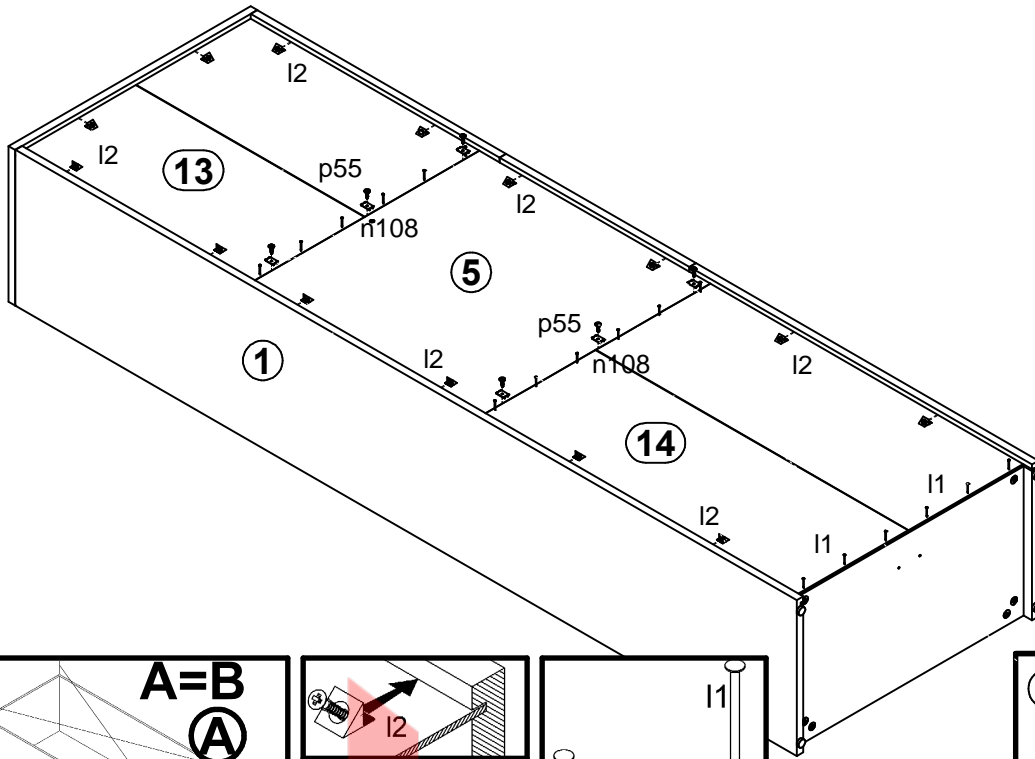

6

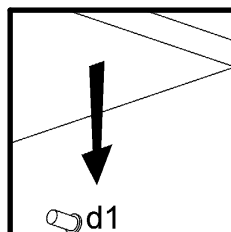
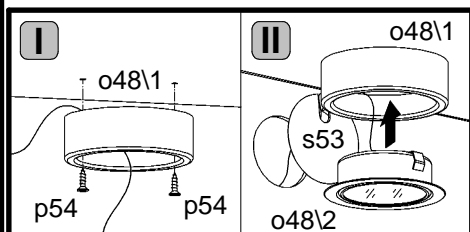
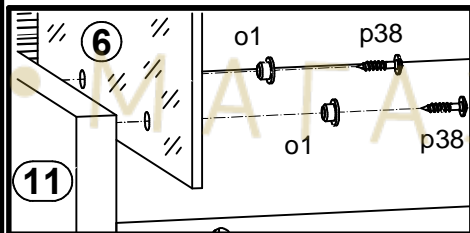
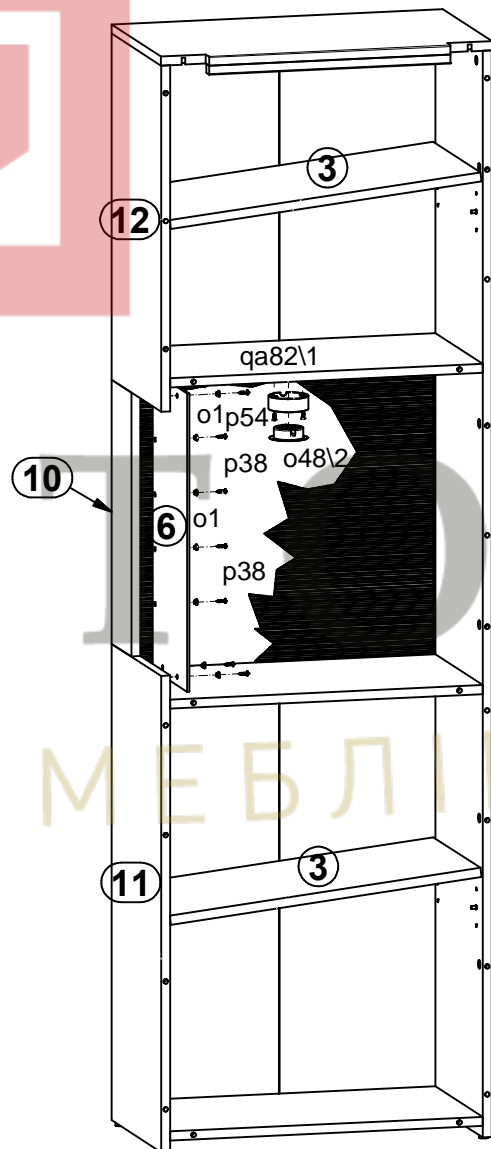

7

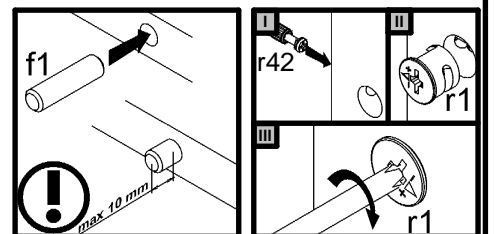
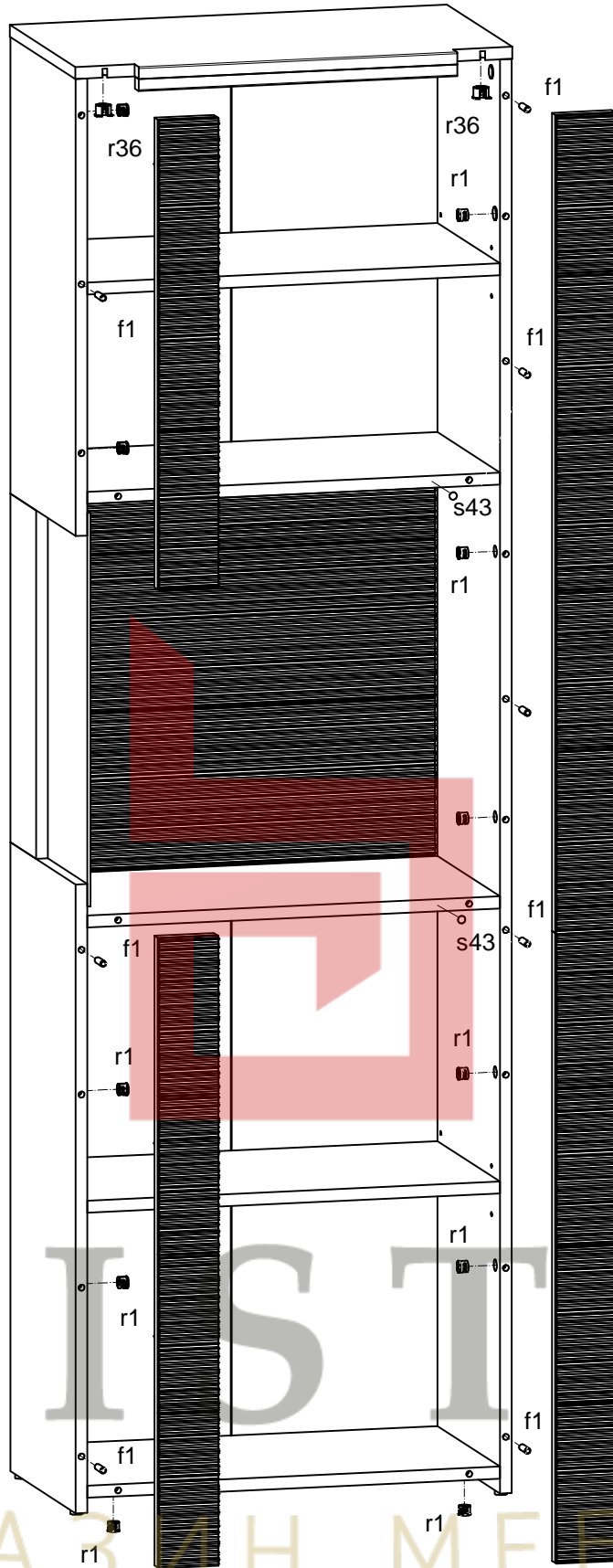

RAFLO

S126-REG1W/19/6-FR2

A	B	C	D
1	S126-558	484	522
2	S126-748	813	424
3	S126-749	587	424

