

RAFLO

S126-SFW1K/4/15

A	B	C	D	
1	S126-115	334	229	1/2
2	S126-116	334	209	1/2
3	S126-117	334	209	1/2
4	S126-118	334	209	1/2
5	S126-205	1519	251	1/2
6	S126-576	368	80	1/2
7	S126-904	1496	344	2/2

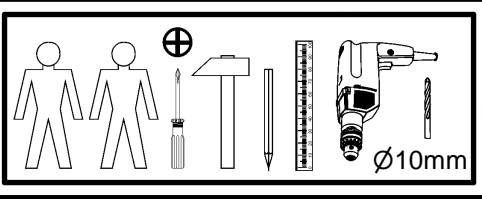
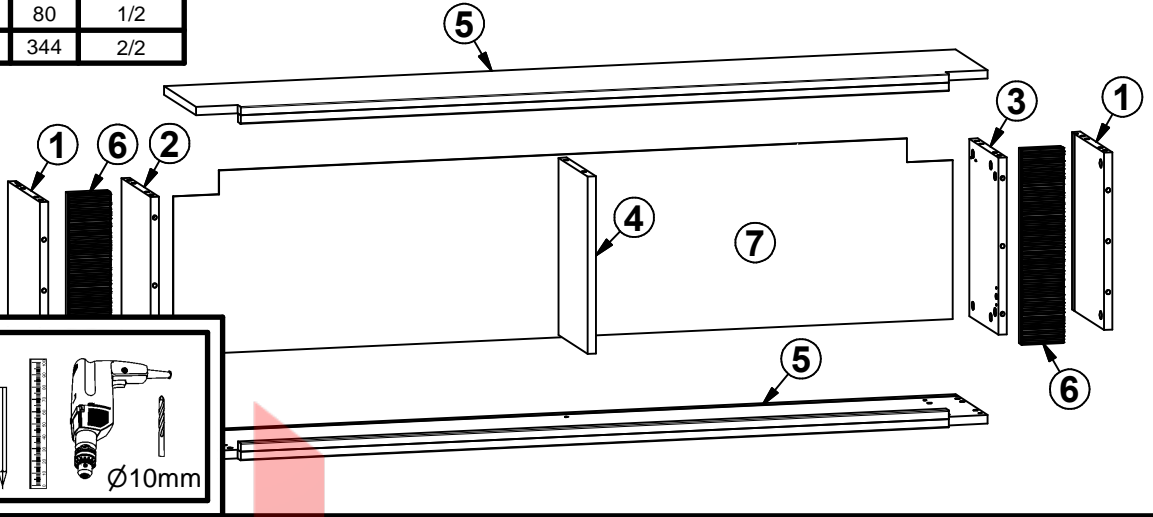
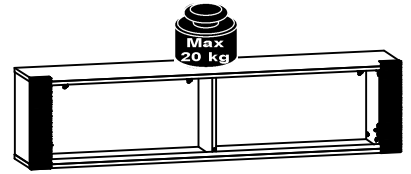

28x φ8x30 mm f1	2x φ10x50 mm f35	10x I1	14x I2	2x m25\2	2x 50 N m25\7	2x m25\9	1x n38\L	1x n38\P
4x φ4x30 mm p21	4x φ5,5x15 mm p51	2x φ5x60 mm p75	20x φ15x12mm #16 r1	20x r16	14x ø16 s2	1x φ11x5 mm s43	1x z1	

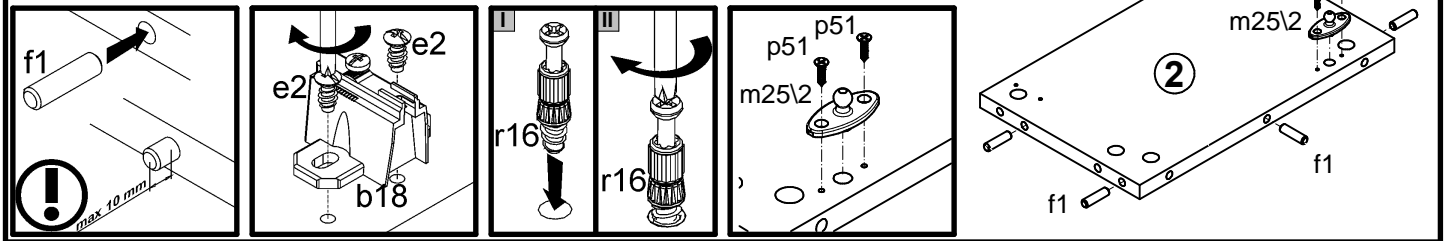
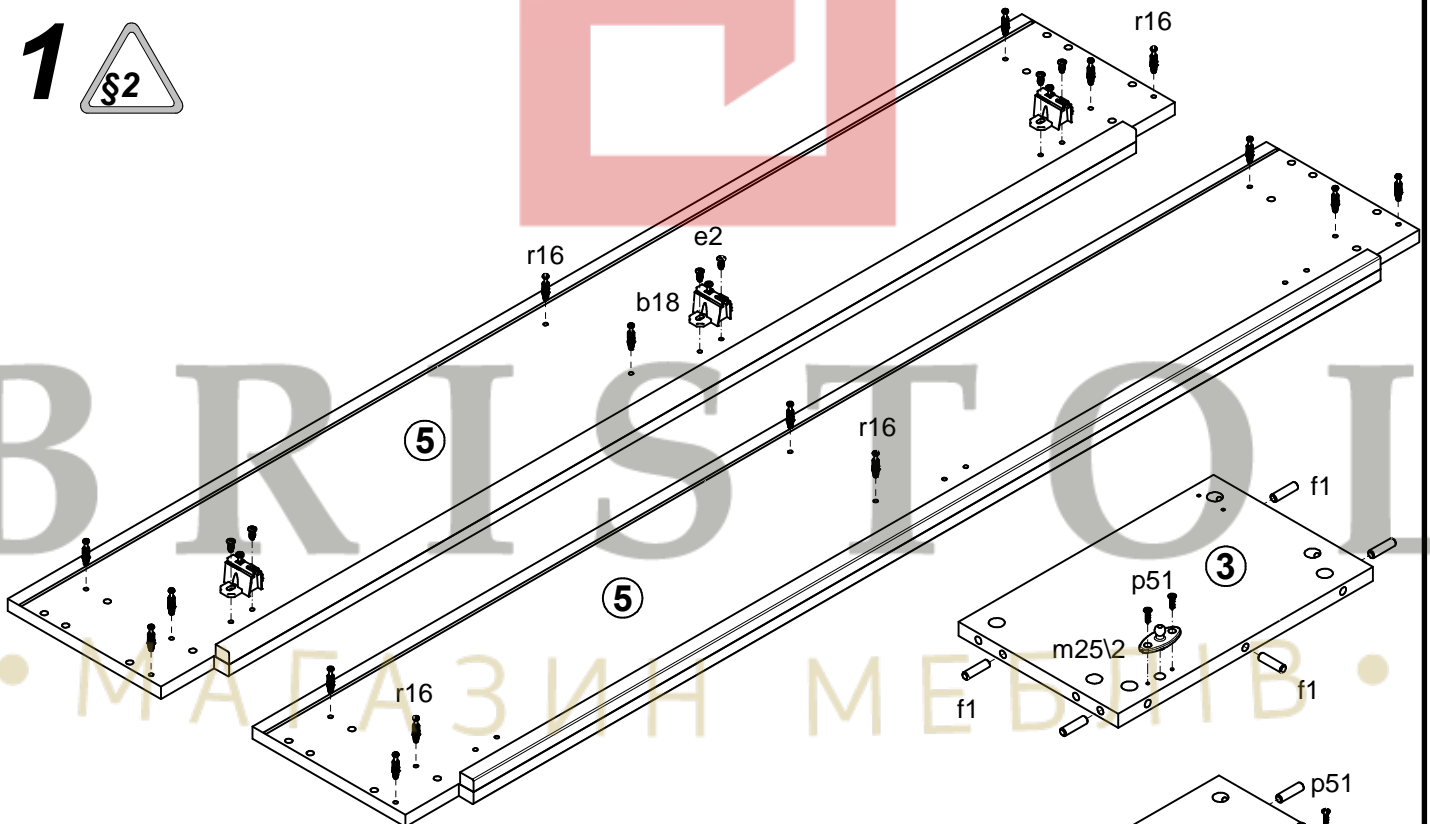

2

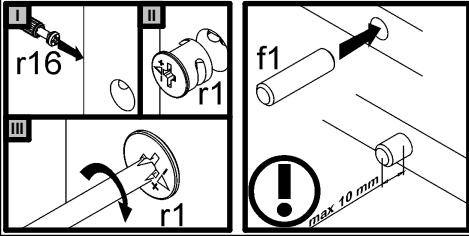
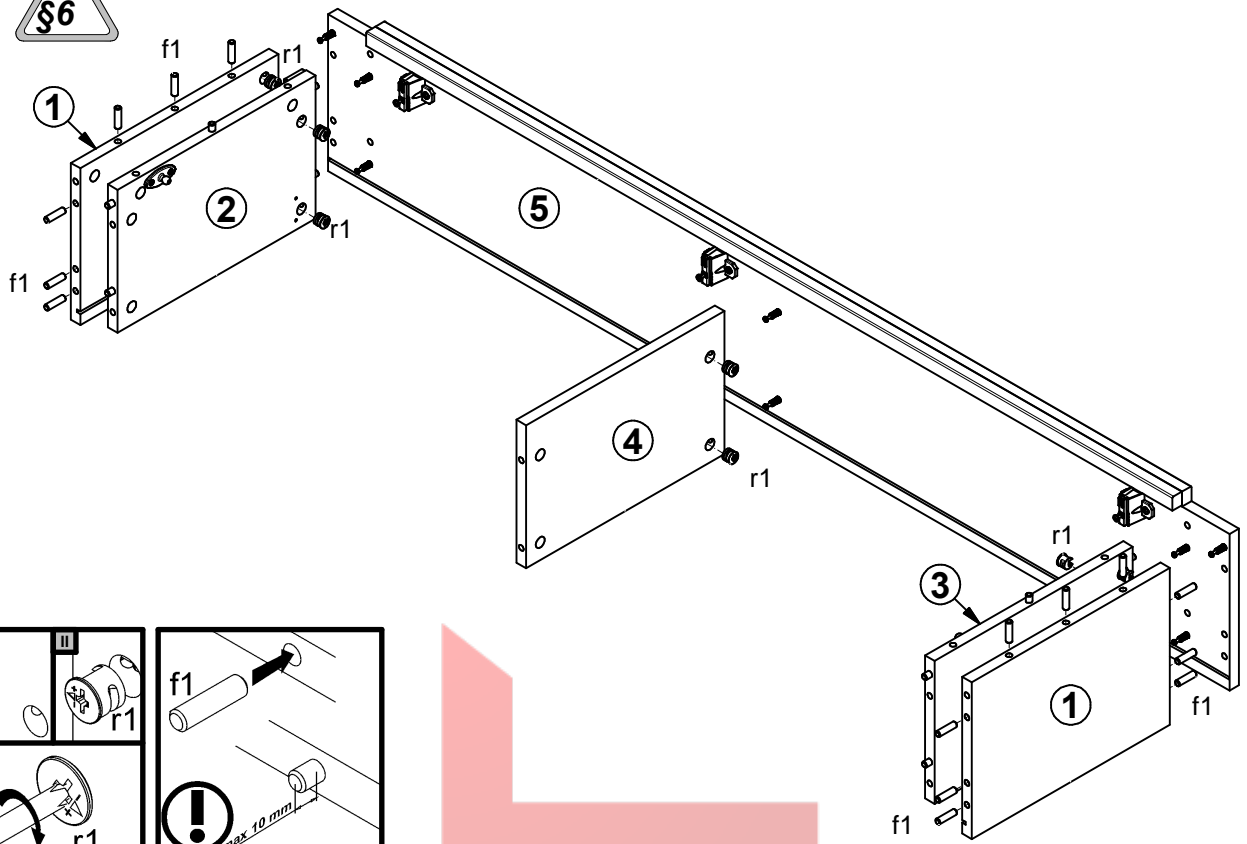

3

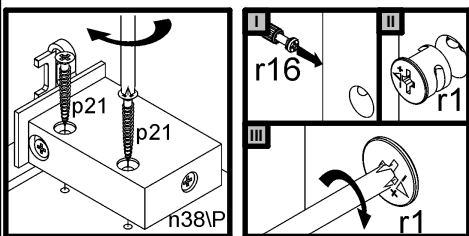
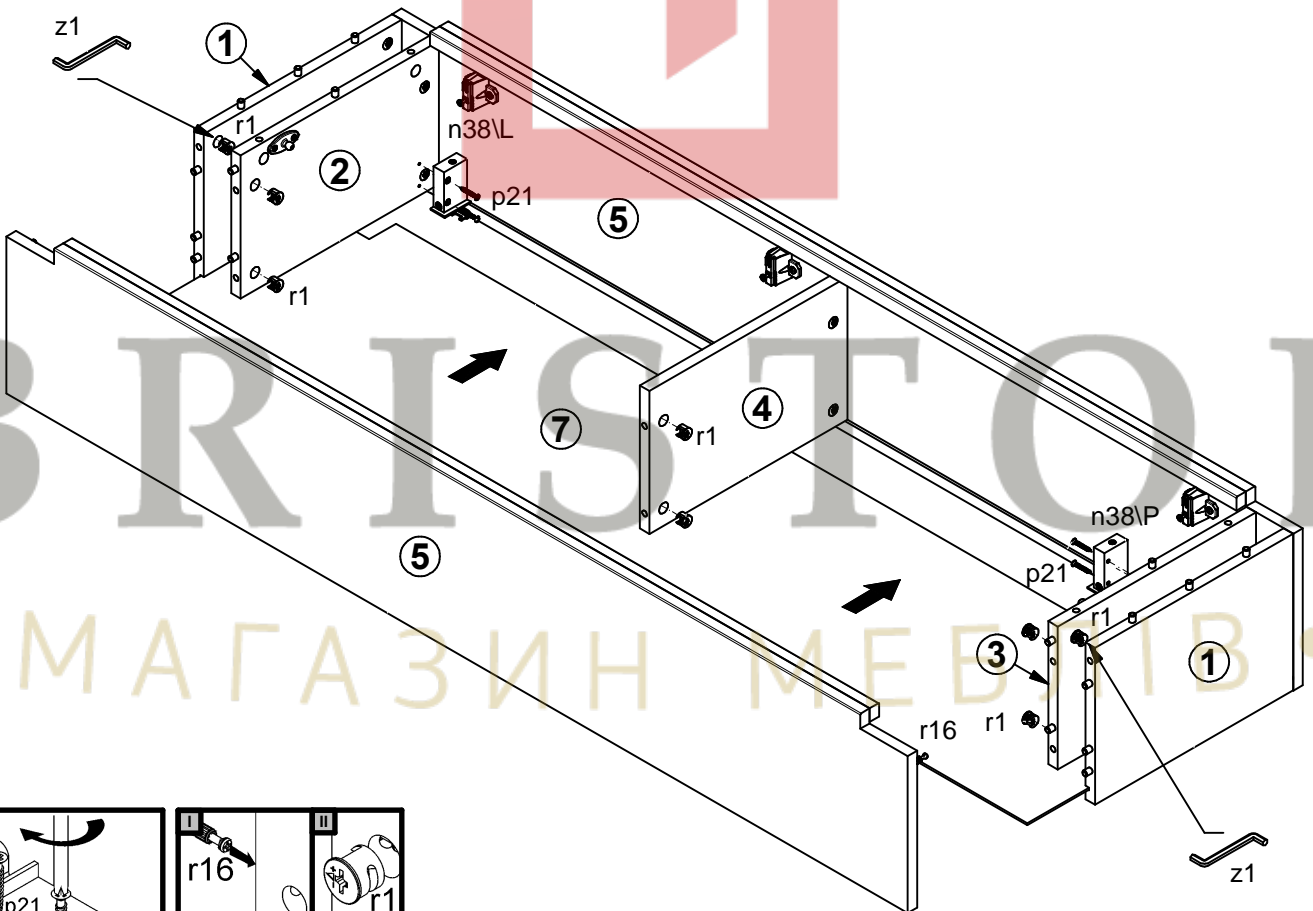

5

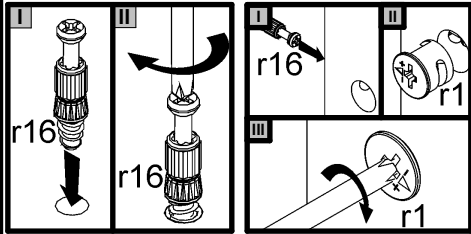
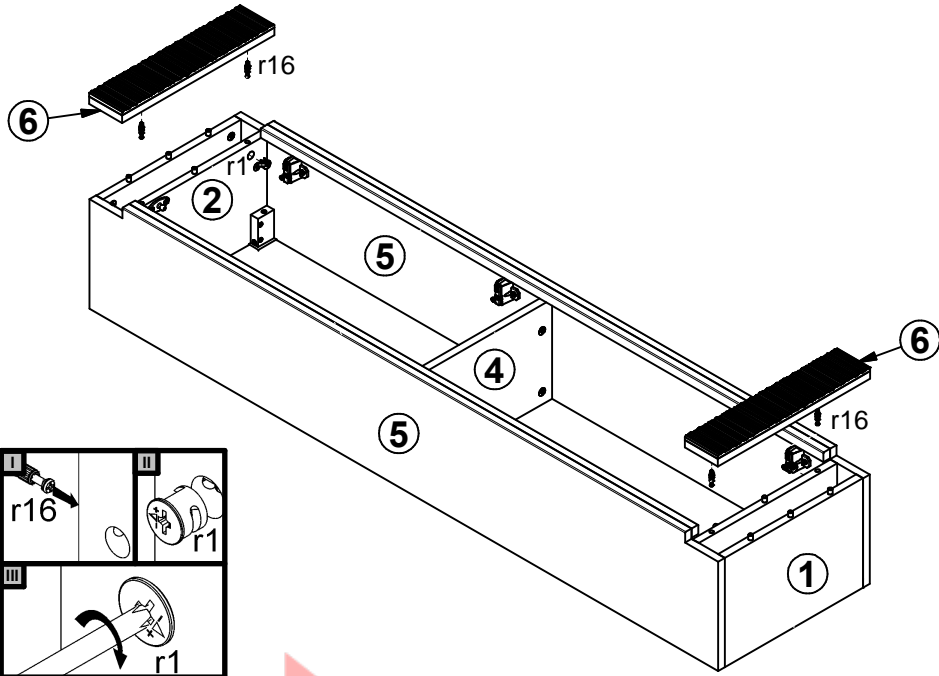

6

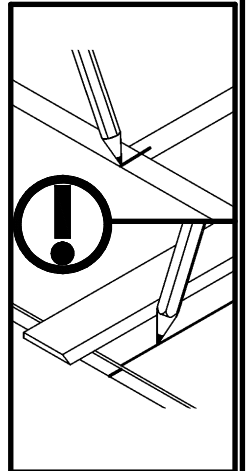
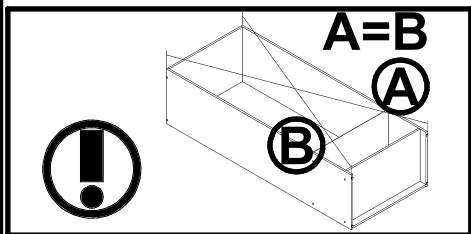
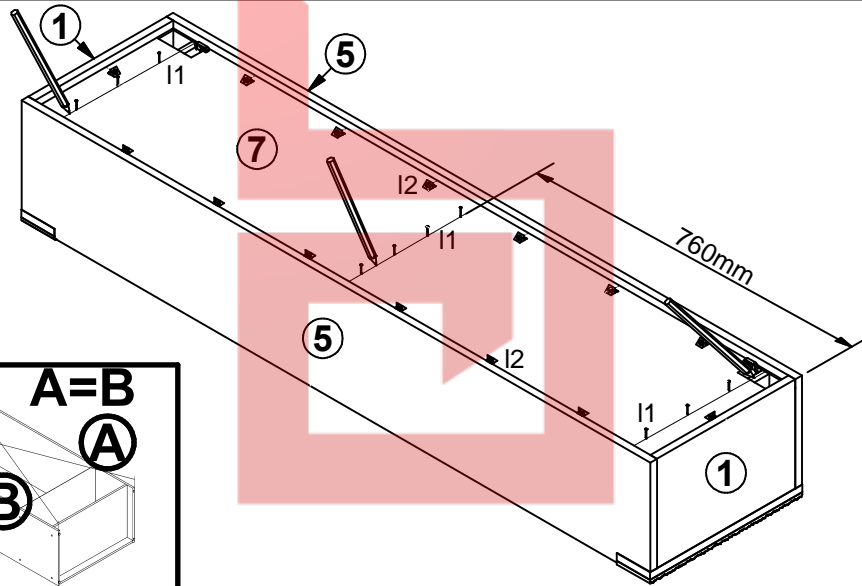

7

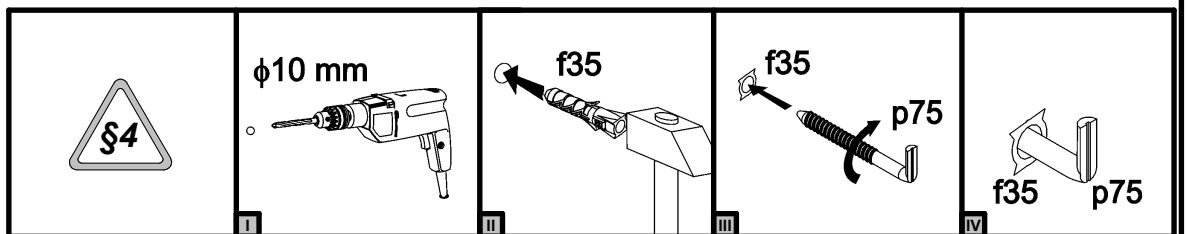
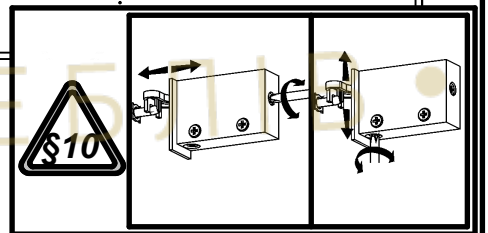
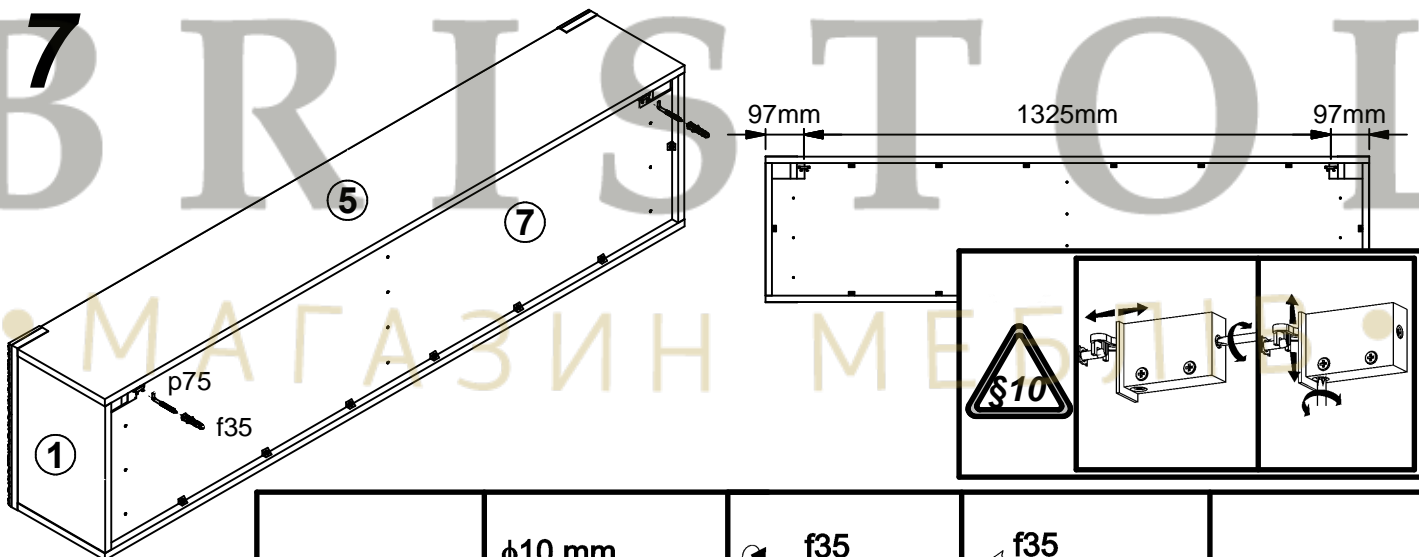







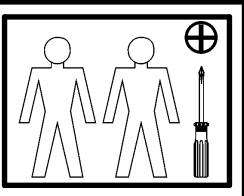
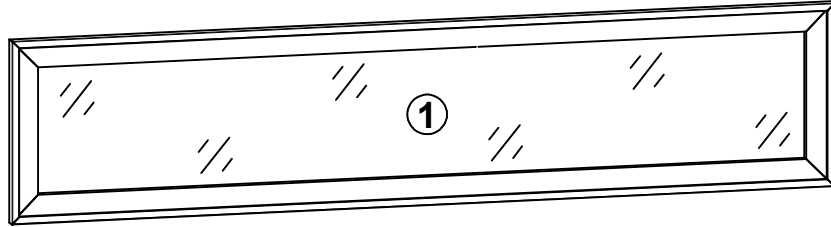
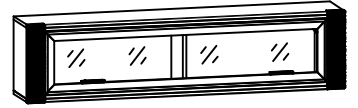

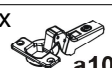
RAFLO

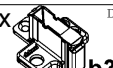
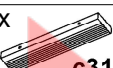
S126-SFW1WK\4\15-FR

A	B	C	D
1	S126-026	1353	296
			2/2

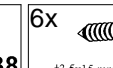

- 3x
 a100
- 3x
 a63
- 3x
 b34
- 2x
 c315
- 6x
 e5
φ6,3x13 mm
- 4x
 o27
φ6,5φ10x5,2mm
- 4x
 p1
φ3,5x13 mm
- 4x
 p38
φ3,5x16 mm
- 6x
 p51
φ3,5x15 mm

- 1x
 s62

