

# OREGON

## S157-SZF3D

A	B	C	D	A	B	C	D		
1	S157-016	1896	494	4/5	11	S157-411	478	70	2/5
2	S157-017	1896	544	5/5	12	S157-414	1033	70	2/5
3	S157-130	1920	540	1/5	13	S157-415	1033	70	2/5
4	S157-131	1920	540	1/5	14	S157-503	515	40	2/5
5	S157-132	1920	574	1/5	15	S157-513	1538	74	2/5
6	S157-216	1558	599	2/5	16	S157-517	1884	29	1/5
7	S157-217	1558	599	2/5	17	S157-918	1969	1053	1/5
8	S157-314	1033	540	3/5	18	S157-919	1969	498	1/5
9	S157-315	478	540	3/5	19	dr-1026	1026	30	1/5
10	S157-316	477	539	3/5					

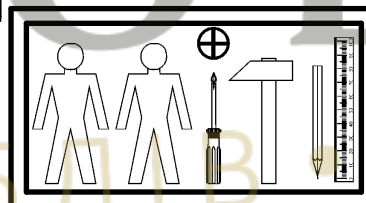
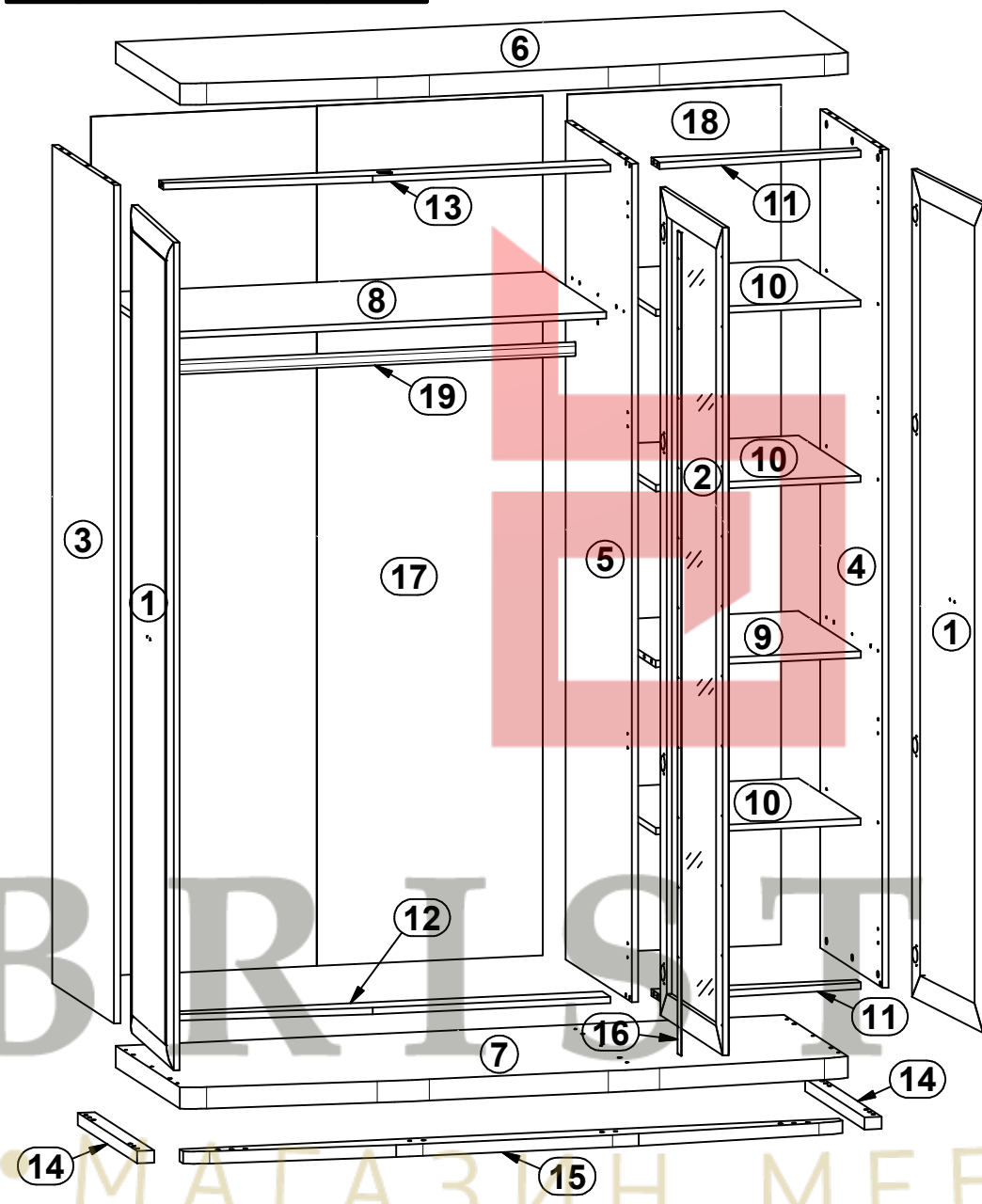
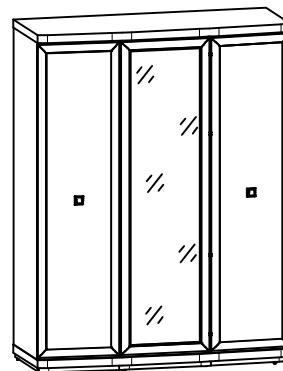

8x  a44	4x  a68	8x  b19	4x  b33	2x  c333	12x  φ5x17 mm d1	8x  φ7x50 mm e1	24x  φ6,3x13 mm e2	30x  φ8x30 mm f1
4x  φ8x50 mm f6	4x  M4x18 mm j59	6x  M6/φ9x14 mm k39/2	6x  M6/22mm k39/3	125x  l1	2x  n1	2x  φ3,5x13 mm p1	12x  φ3,5x13 mm p27	24x  φ3,5x15 mm p51
30x  φ1,5x12mm #16 r1	30x  r42	24x  ø16 s2	1x  z1					

1  

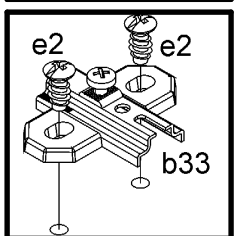
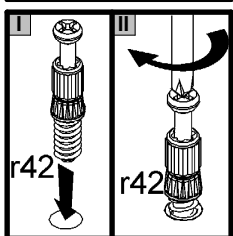
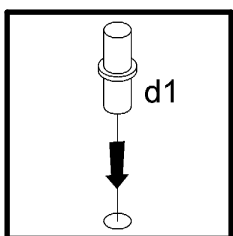
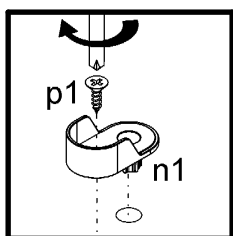
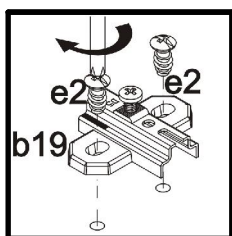
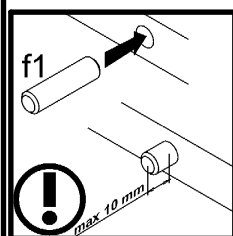
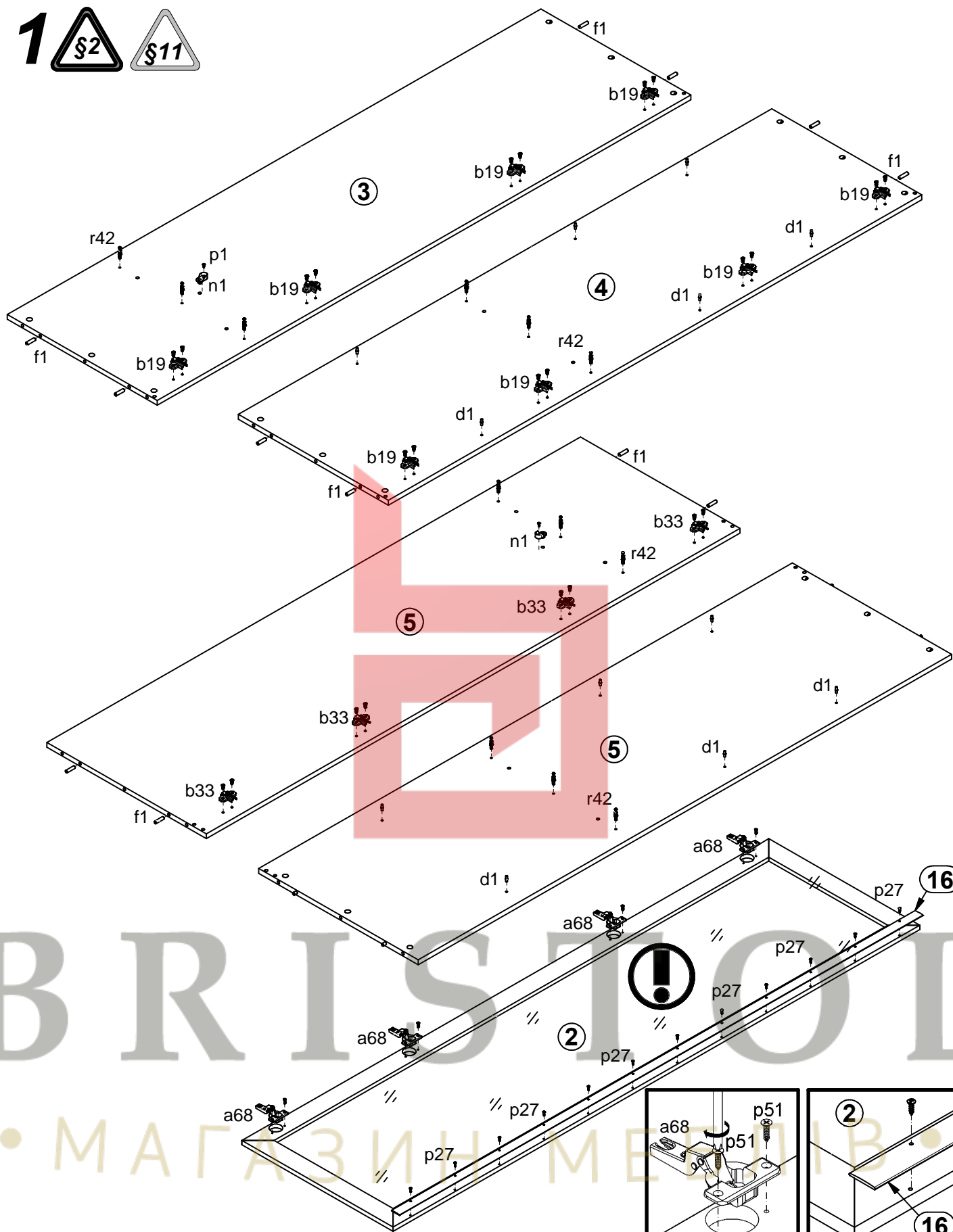

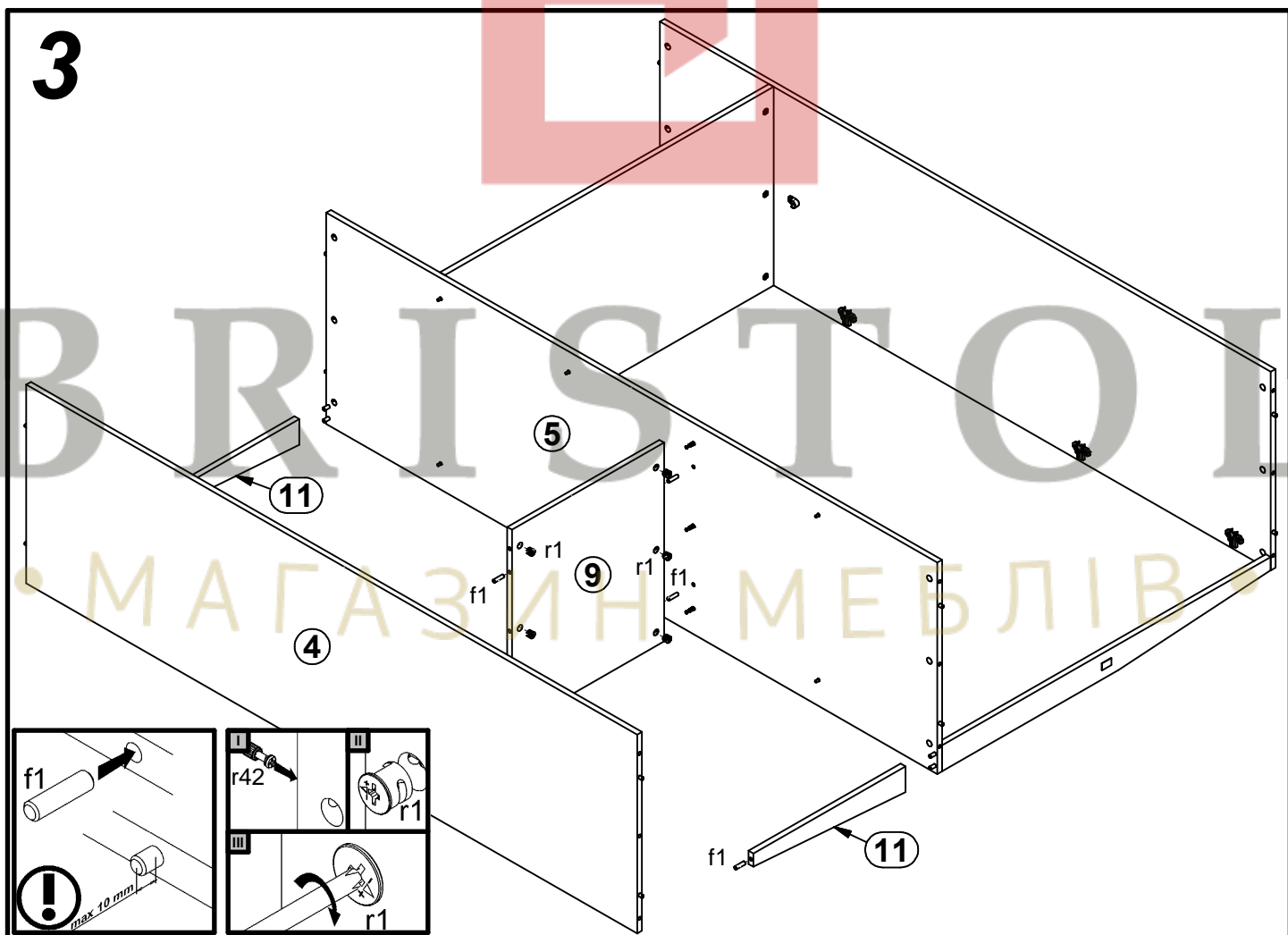
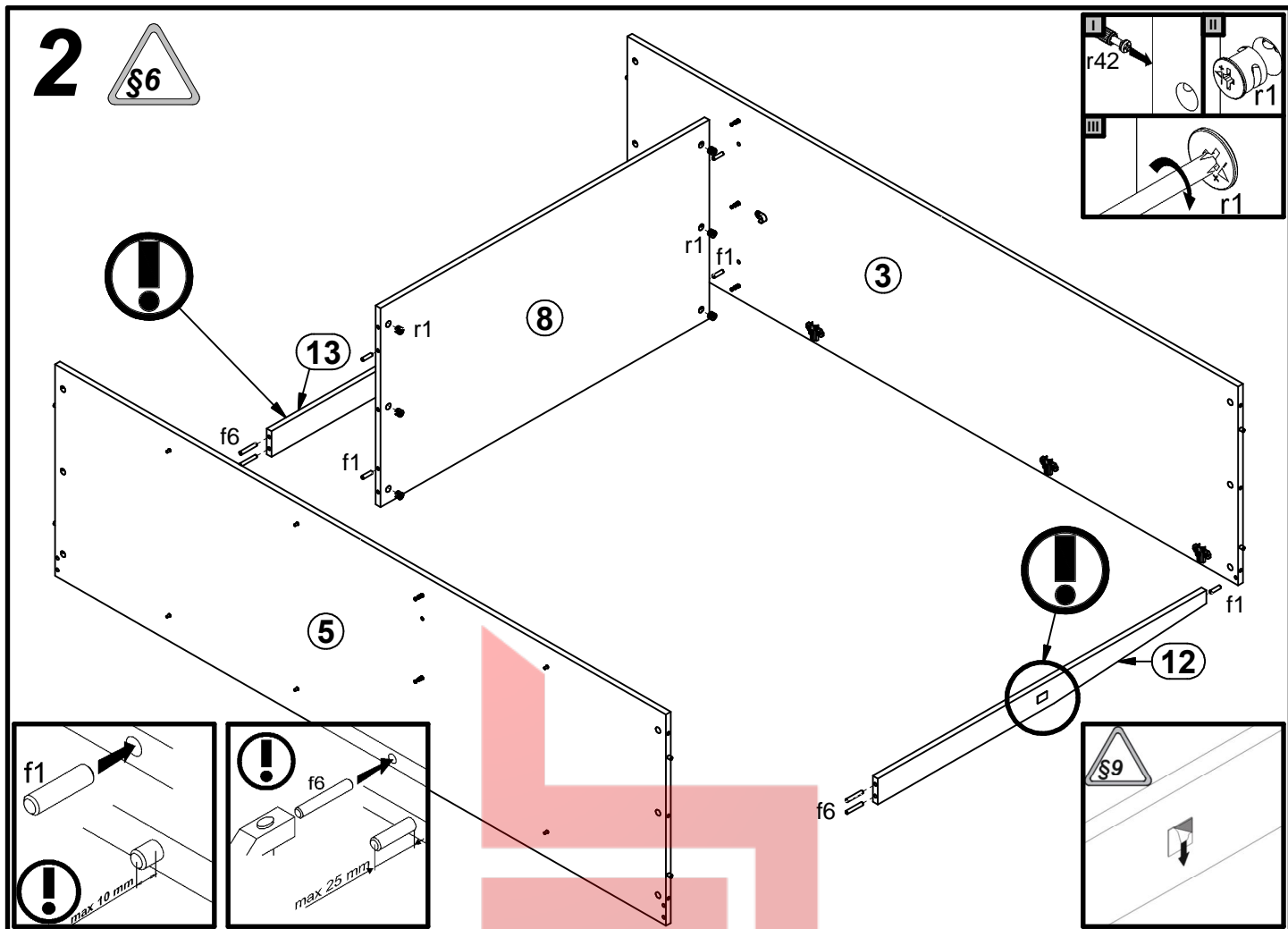

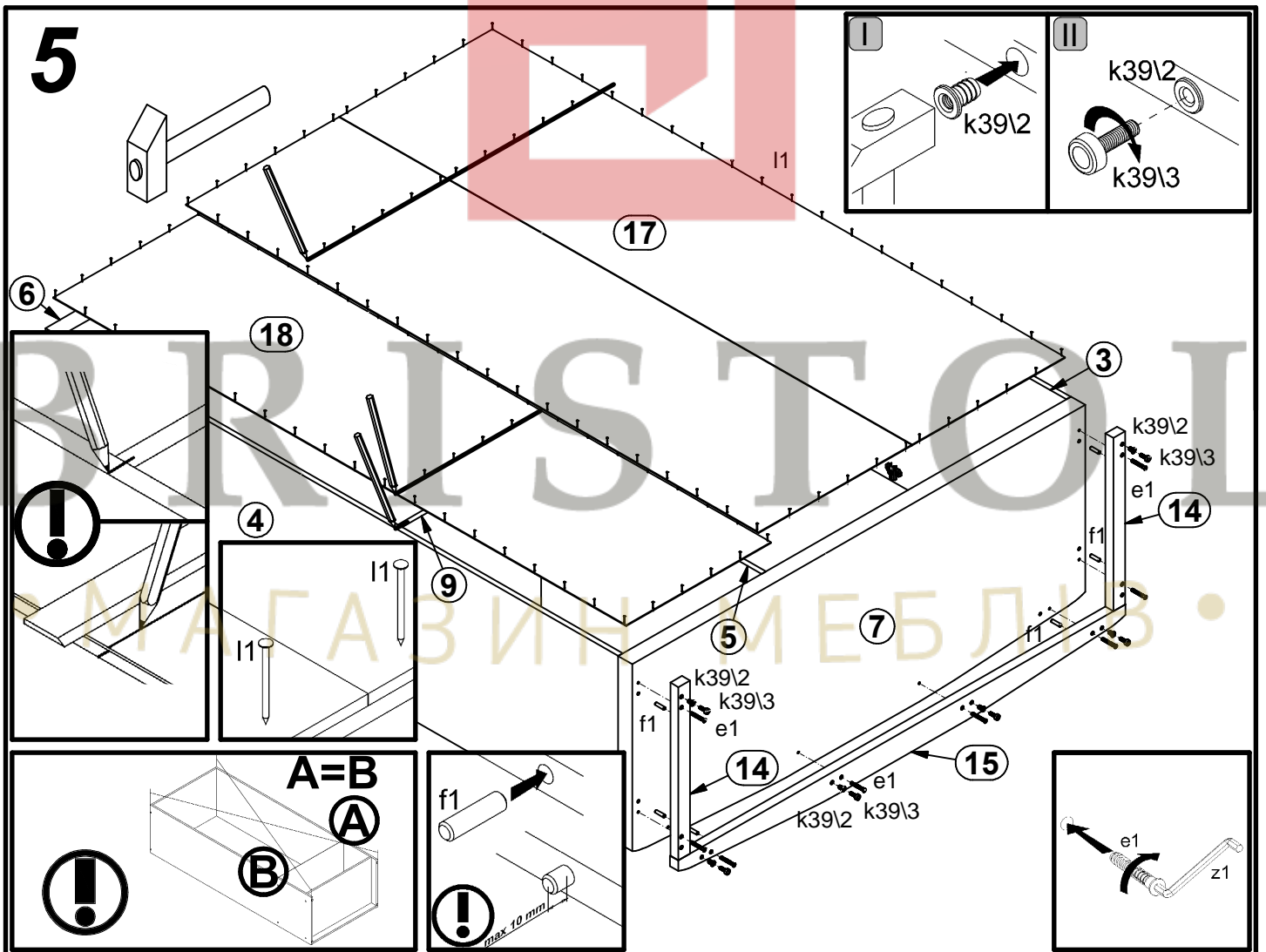
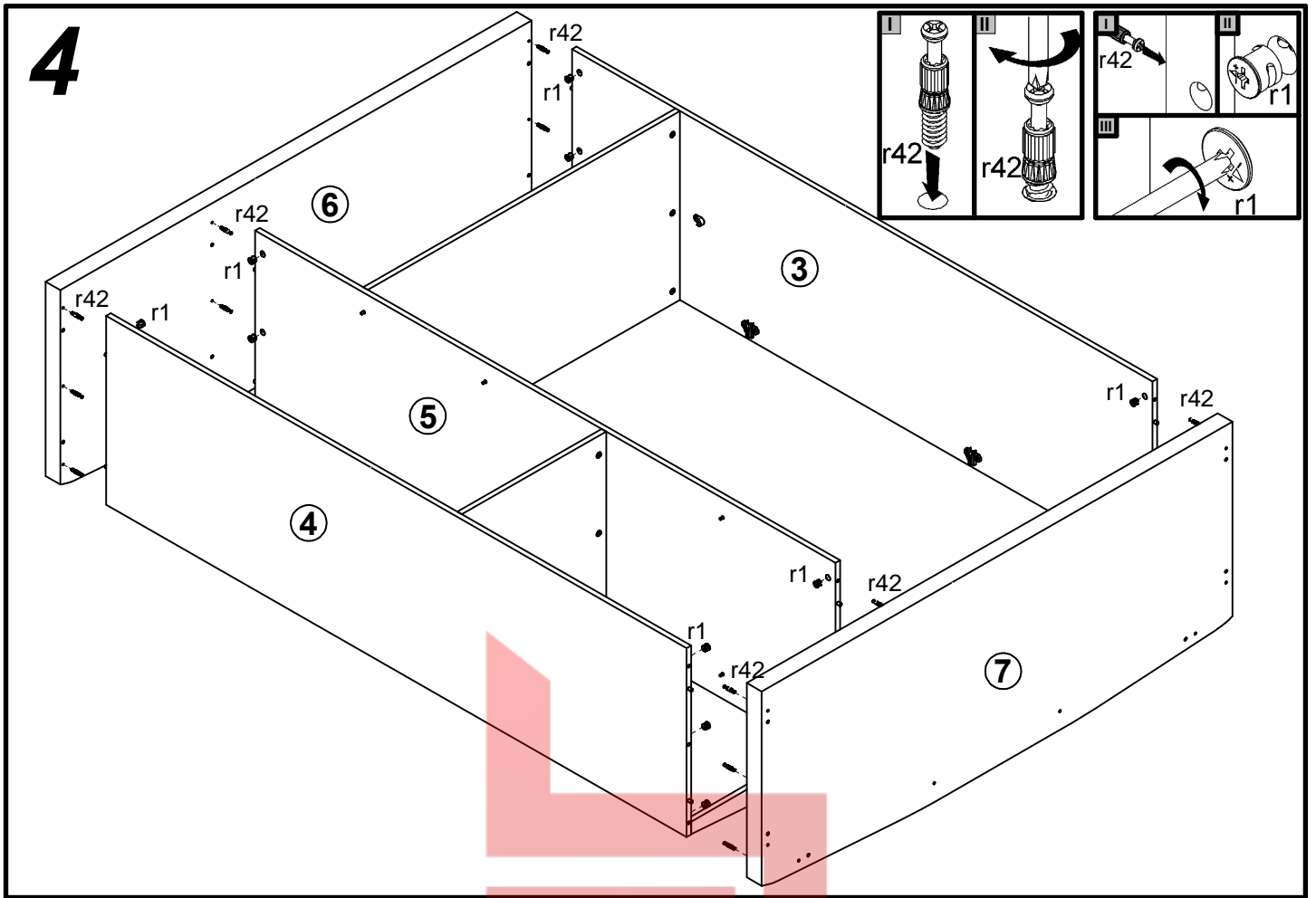

# 6

