

# KASPIAN

## S128-REG2D2S

A	B	C	D	
1	S128-002	822	176	3/4
2	S128-025	1468	410	4/4
3	S128-026	1468	410	4/4
4	S128-105	1964	396	1/4
5	S128-106	1964	396	1/4
6	S128-209	900	399	2/4
7	S128-316	862	370	2/4
8	S128-326	863	370	2/4
9	S128-401	863	60	2/4
10	S128-902	1935	893	1/4
11	S128-926	789	348	1/4
12	ZS2-511	350	120	2/4
13	ZS2-512	350	120	2/4
14	ZS2-5513	778	120	2/4

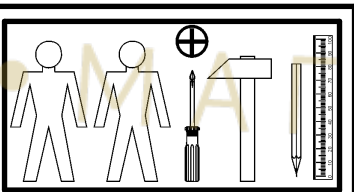
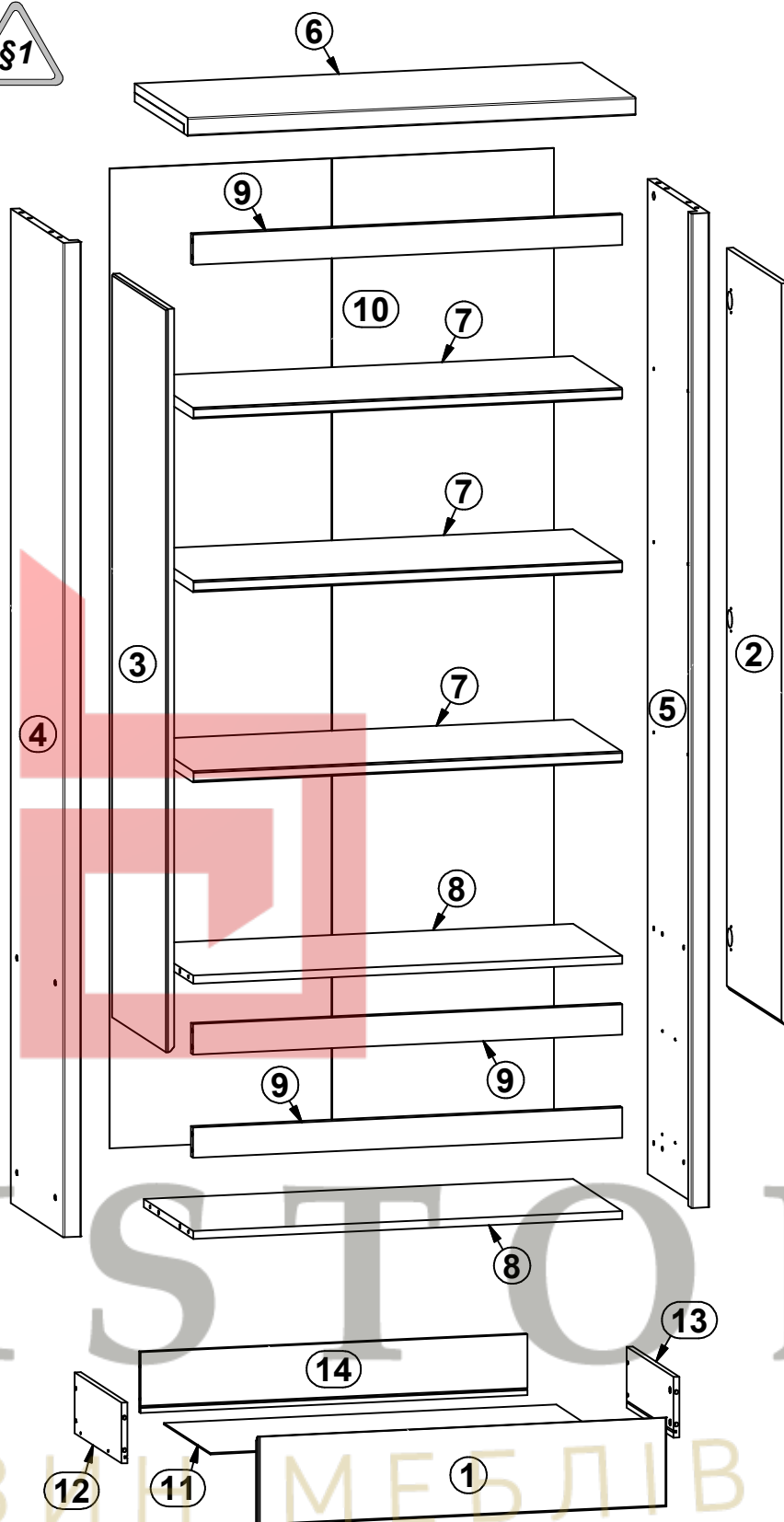
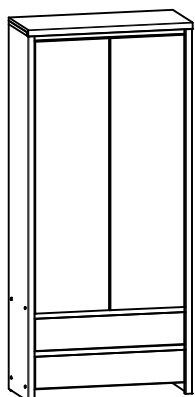

6x  a43	6x  b18	12x  d1 φ5x17 mm	8x  e1 φ7x50 mm	12x  e16 φ6x30 mm	8x  e19 φ5x9 mm	12x  e2 φ6,3x13 mm	24x  f1 φ8x30 mm	8x  f25 φ6,5x40 mm
4x  k1	65x  l1	4x  p25 φ3,5x16 mm	12x  p51 φ3,5x15 mm	4x  r1 φ1,5x12mm #16	8x  r15 φ12x10,5mm #12	12x  r42	8x  s1 φ16	2x  s2
2x  t19 333 mm	12x  w36 h=18 mm	2x  w45 CL 350 mm	2x  w45 CR 350 mm	2x  w45 DL 350 mm	2x  w45 DR 350 mm	1x  z1	1x  n26 1	1x  p38 φ3,5x16 mm

1 

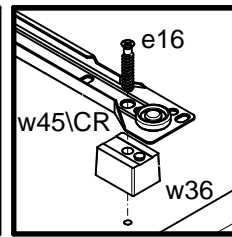
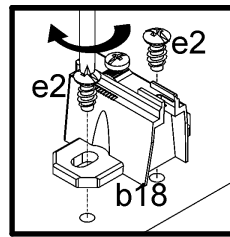
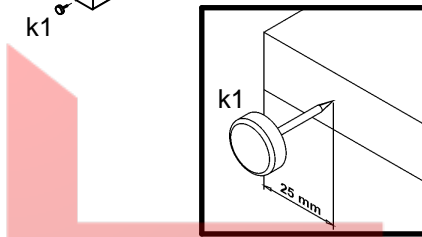
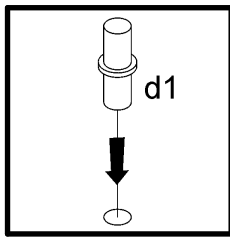
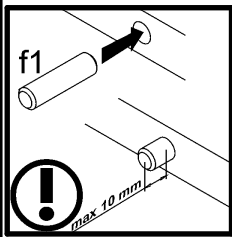
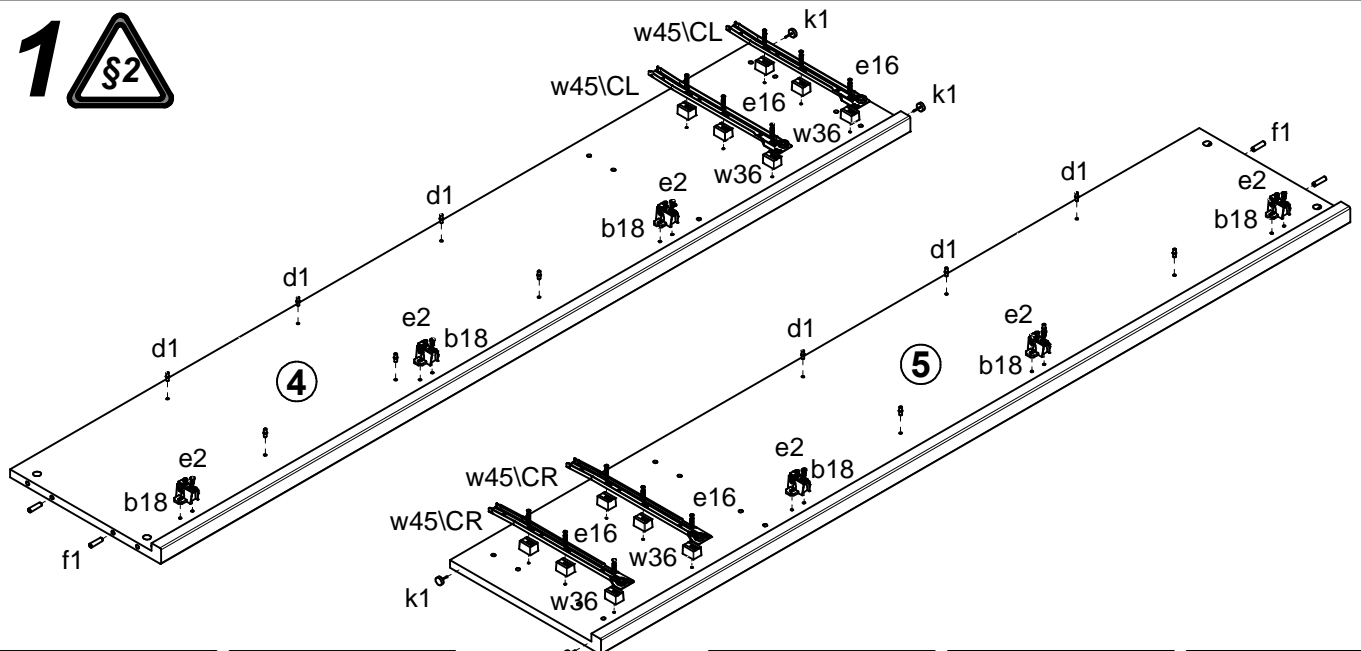

2 

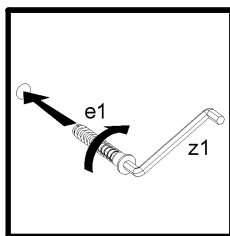
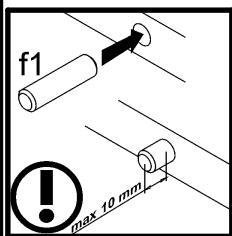
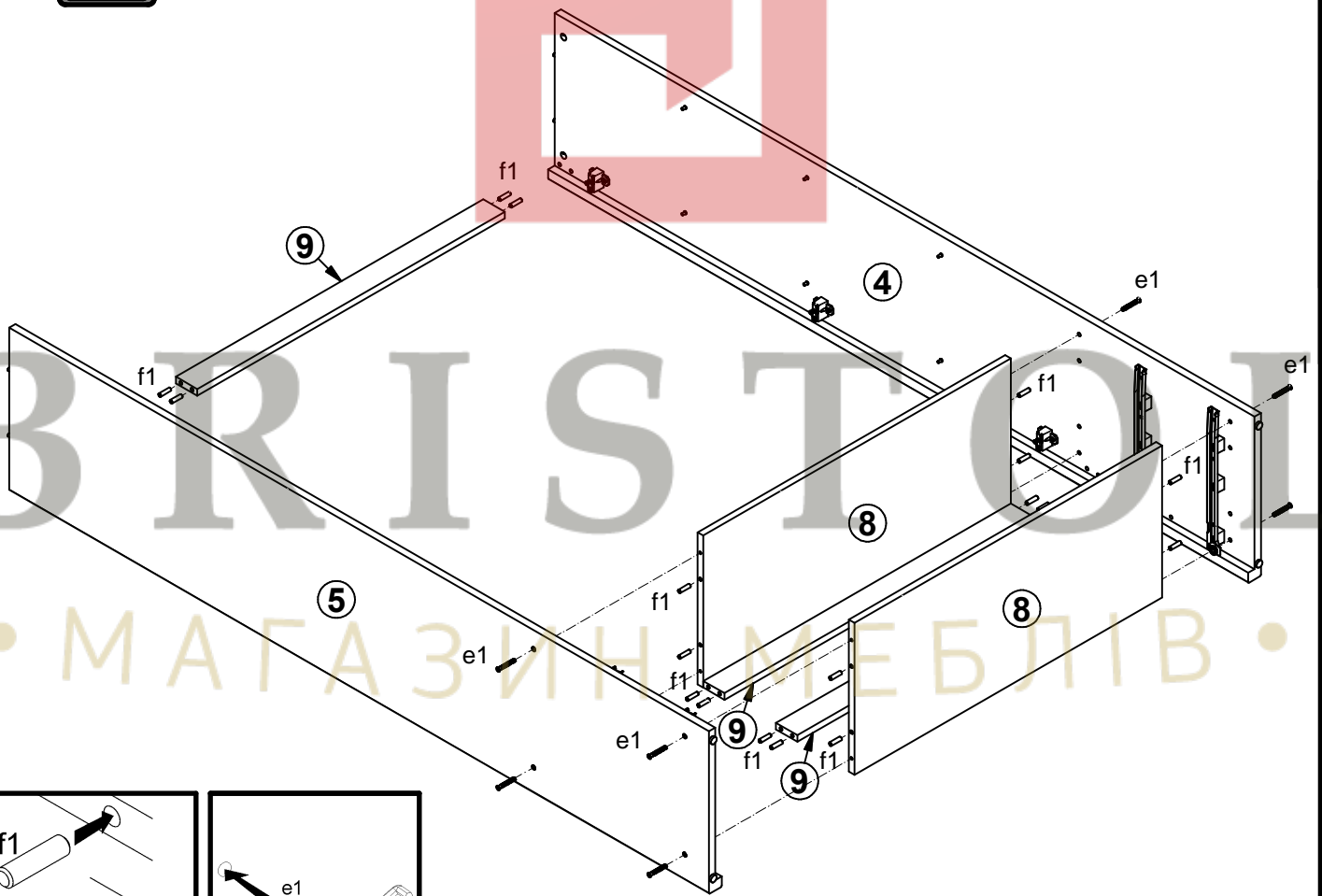

# 3

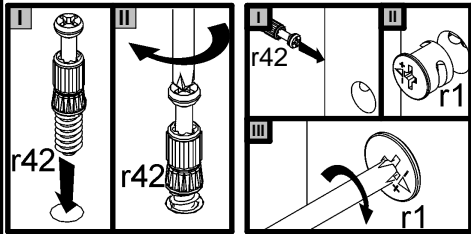
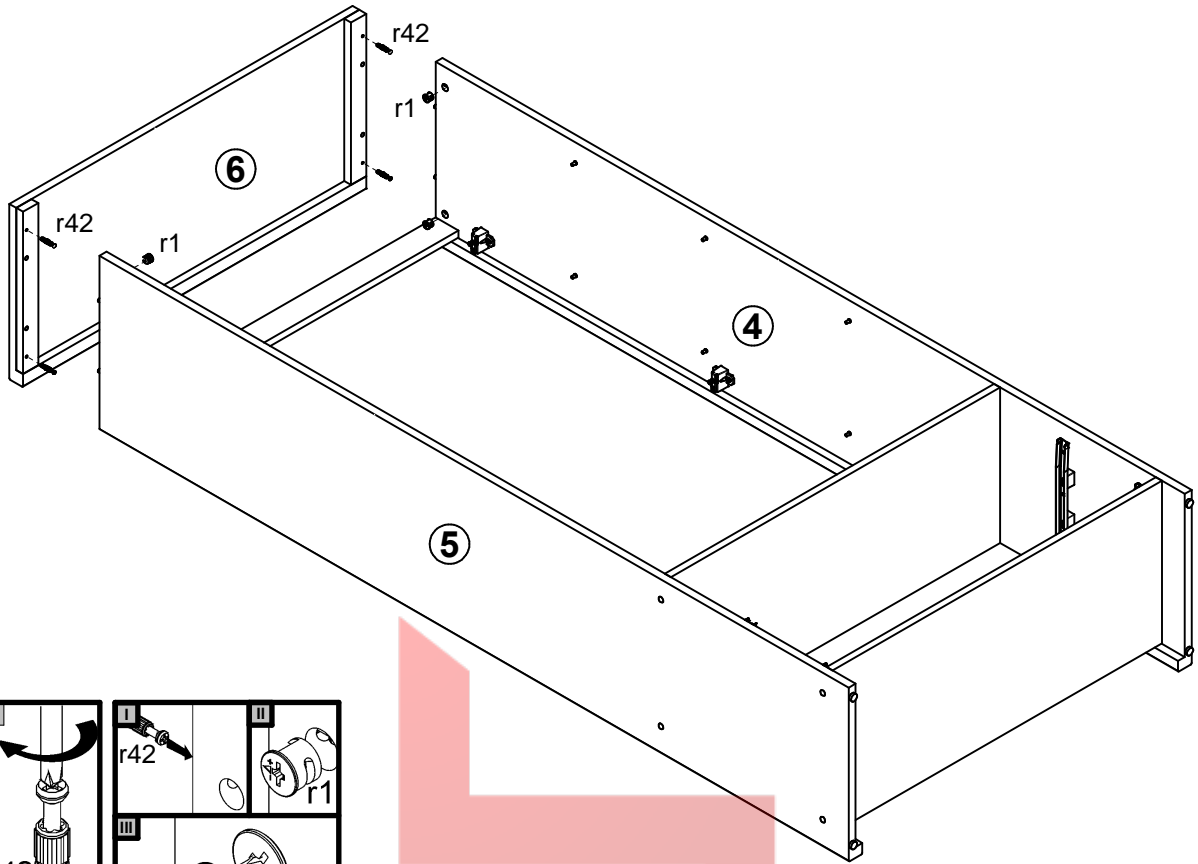

# 4

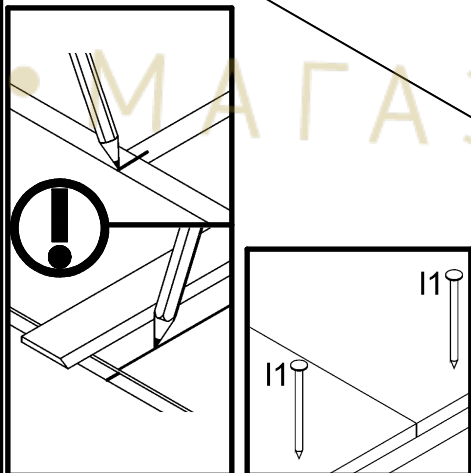
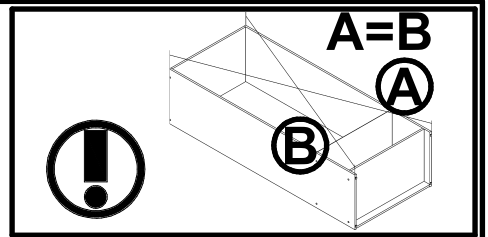
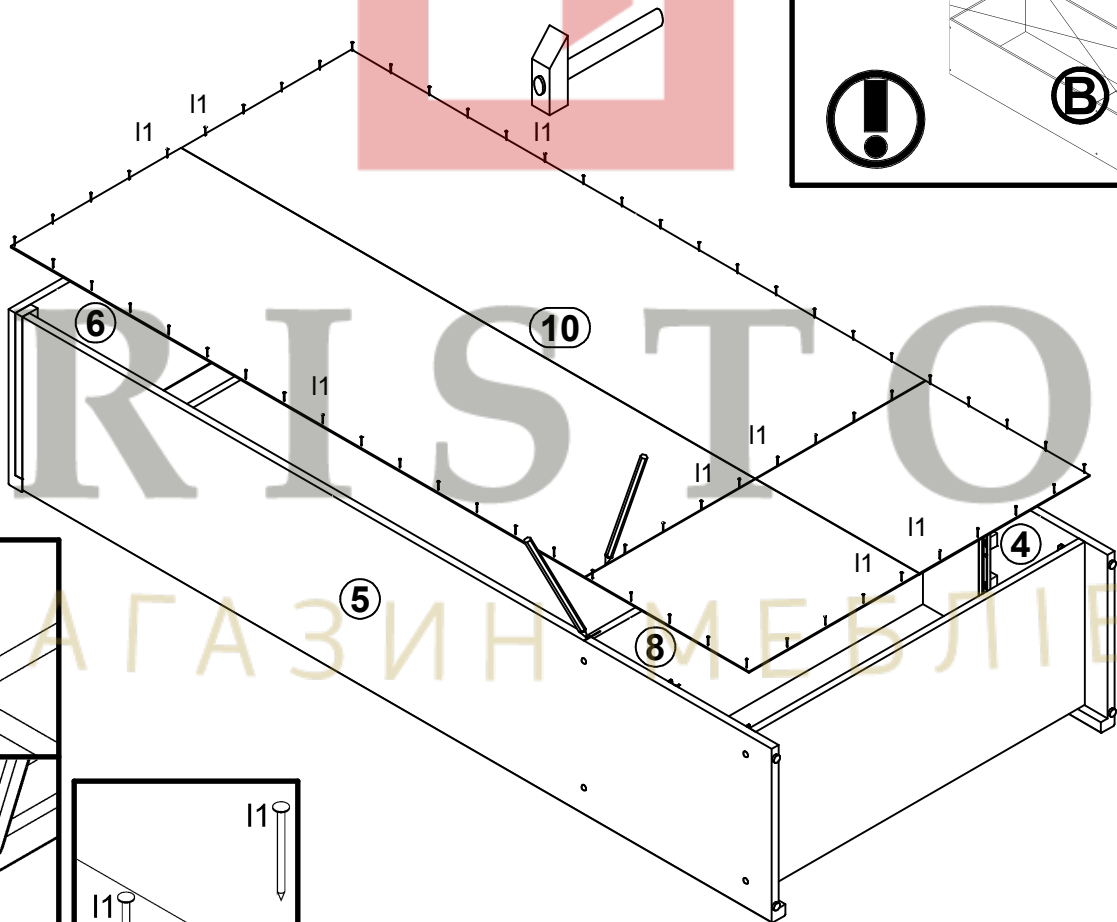

# 5

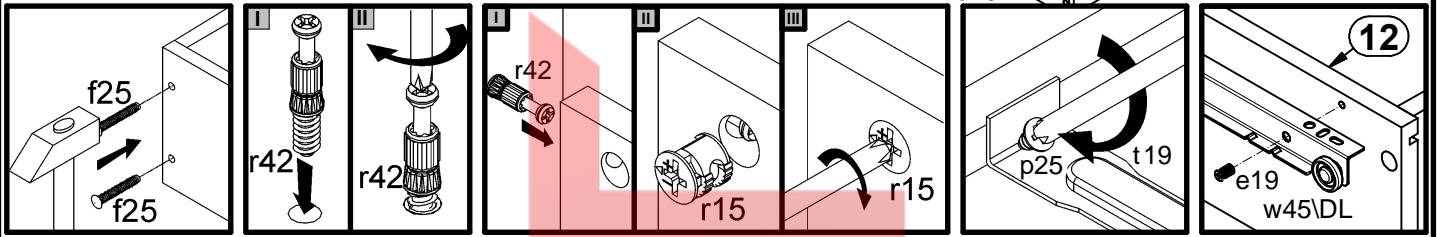
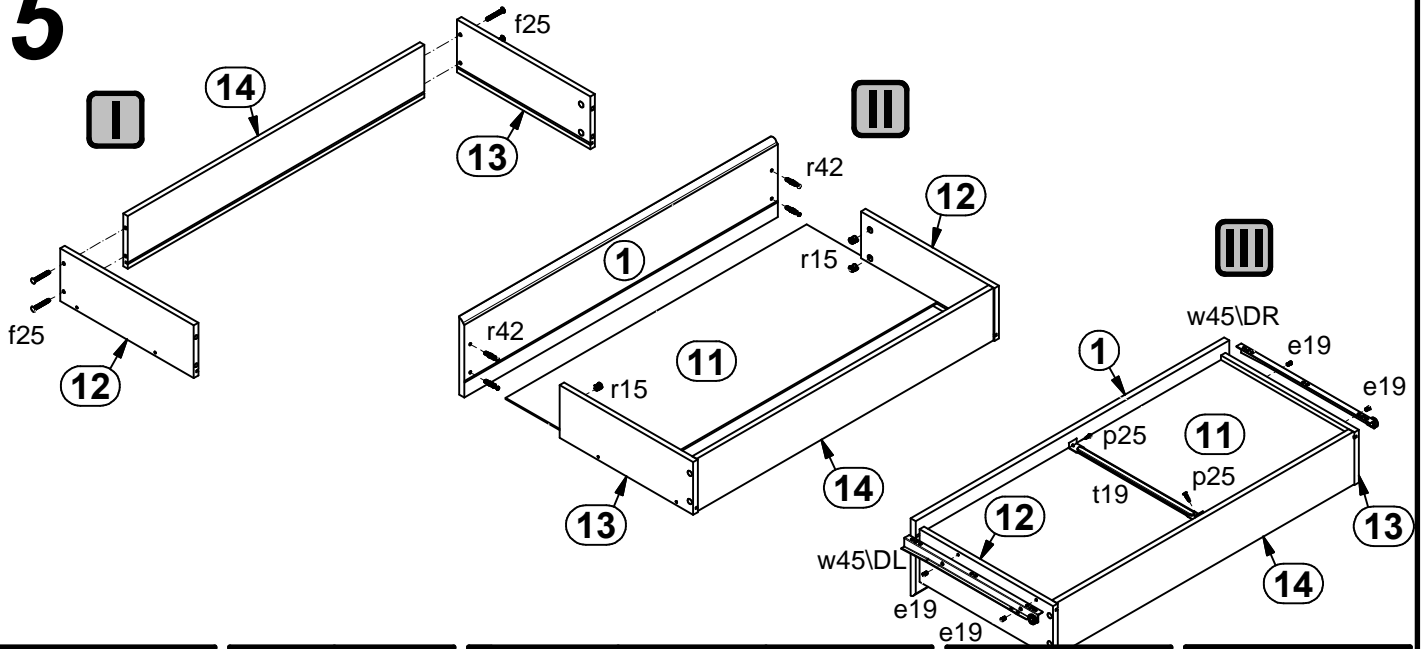

# 6

