

KASPIAN

S128-REG2D2S

A	B	C	D	
1	S128-002	822	176	3/4
2	S128-025	1468	410	4/4
3	S128-026	1468	410	4/4
4	S128-105	1964	396	1/4
5	S128-106	1964	396	1/4
6	S128-209	900	399	2/4
7	S128-316	862	370	2/4
8	S128-326	863	370	2/4
9	S128-401	863	60	2/4
10	S128-902	1935	893	1/4
11	S128-926	789	348	1/4
12	ZS2-511	350	120	2/4
13	ZS2-512	350	120	2/4
14	ZS2-5513	778	120	2/4

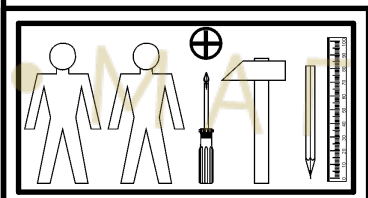
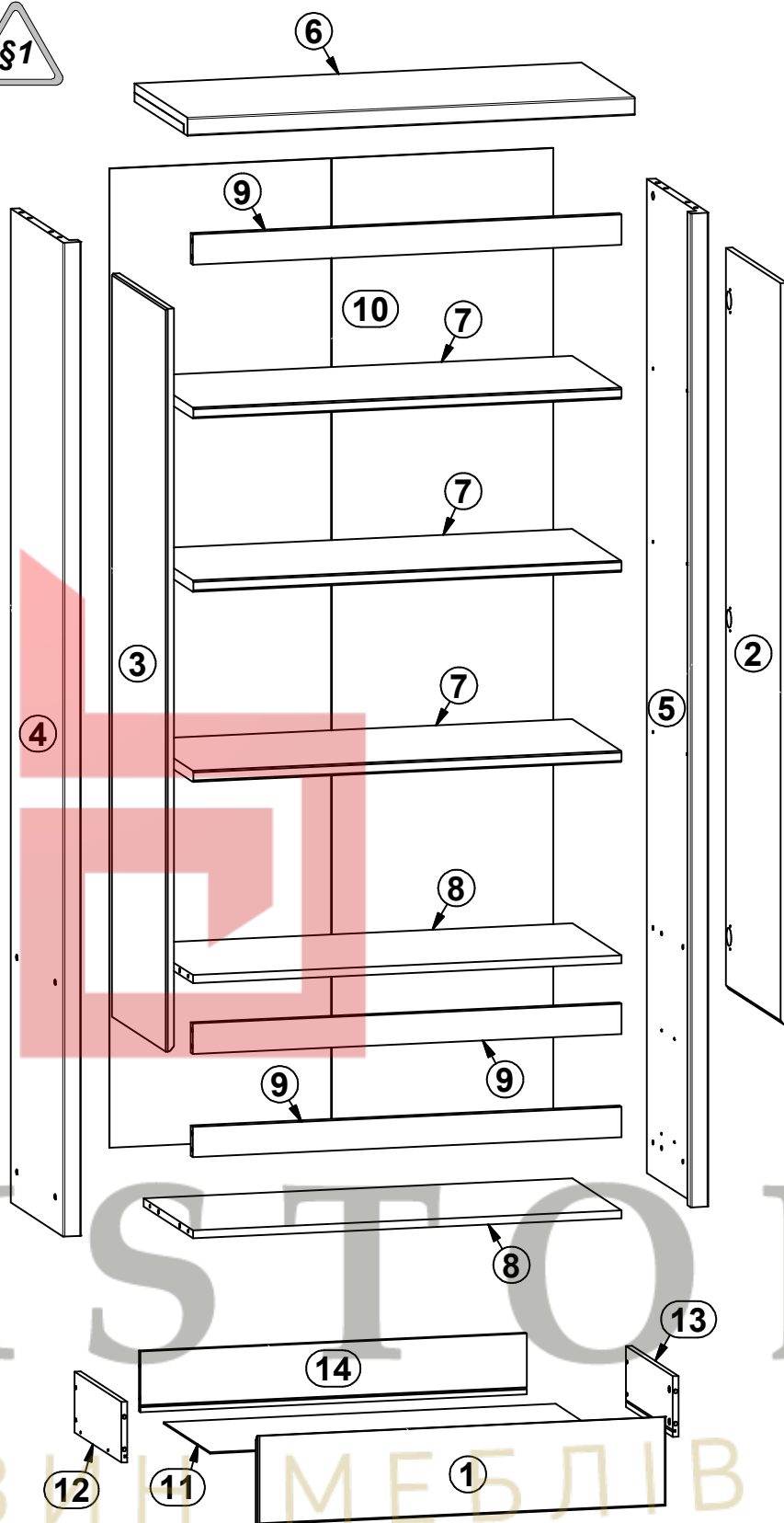
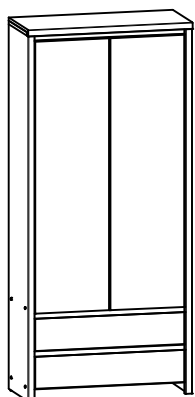

6x a43	6x b18	12x d1 φ5x17 mm	8x e1 φ7x50 mm	12x e16 φ6x30 mm	8x e19 φ5x9 mm	12x e2 φ6,3x13 mm	24x f1 φ8x30 mm	8x f25 φ6,3x40 mm
4x k1	65x l1	4x p25 φ3,5x16 mm	12x p51 φ3,5x15 mm	4x r1 φ1,5x12mm #16	8x r15 φ12x10,5mm #12	12x r42	8x s1 φ16	2x s2
2x t19 333 mm	12x w36 h=18 mm	2x w45 CL 350 mm	2x w45 CR 350 mm	2x w45 DL 350 mm	2x w45 DR 350 mm	1x z1	1x n26 1	1x p38 φ3,5x16 mm

1 

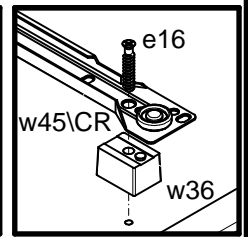
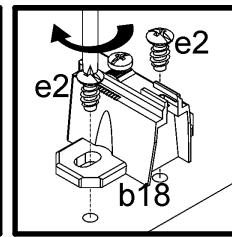
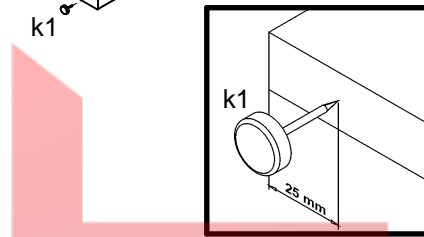
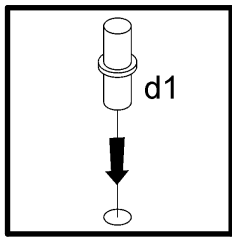
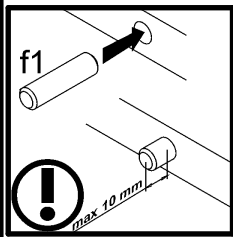
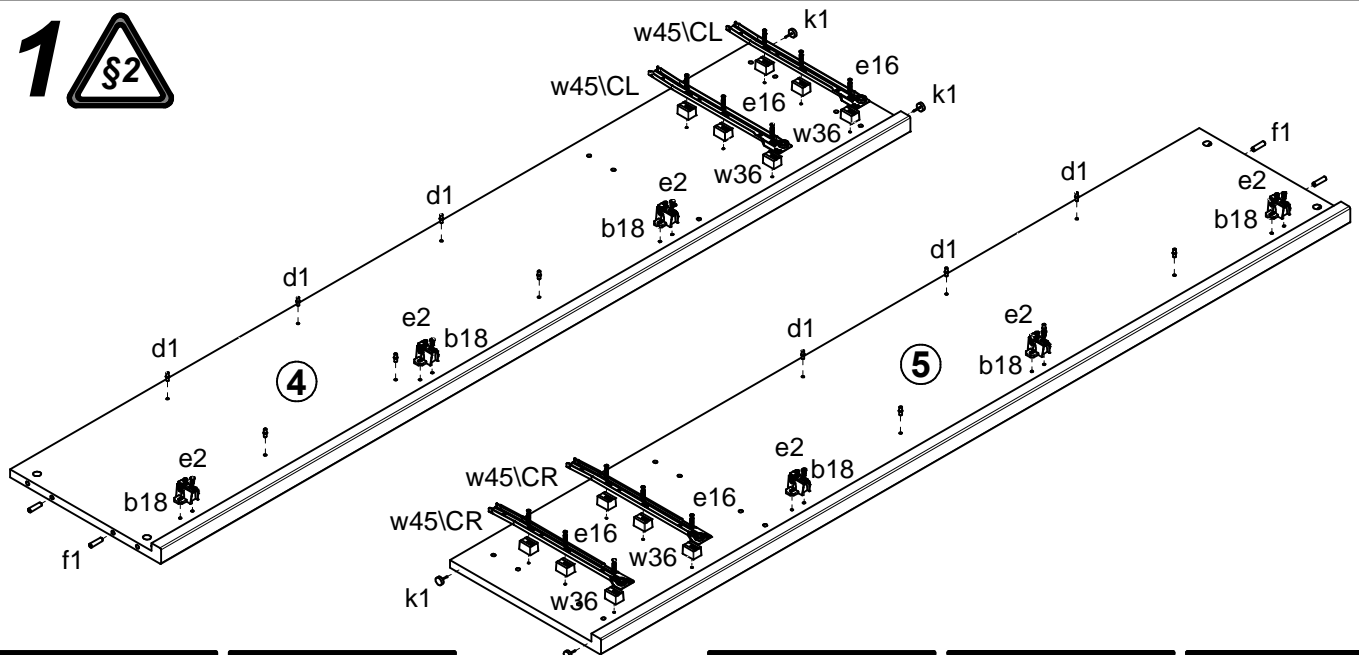

2 

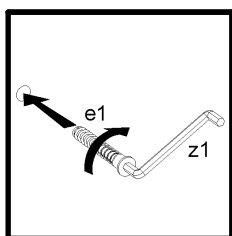
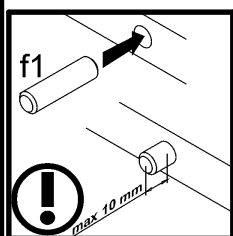
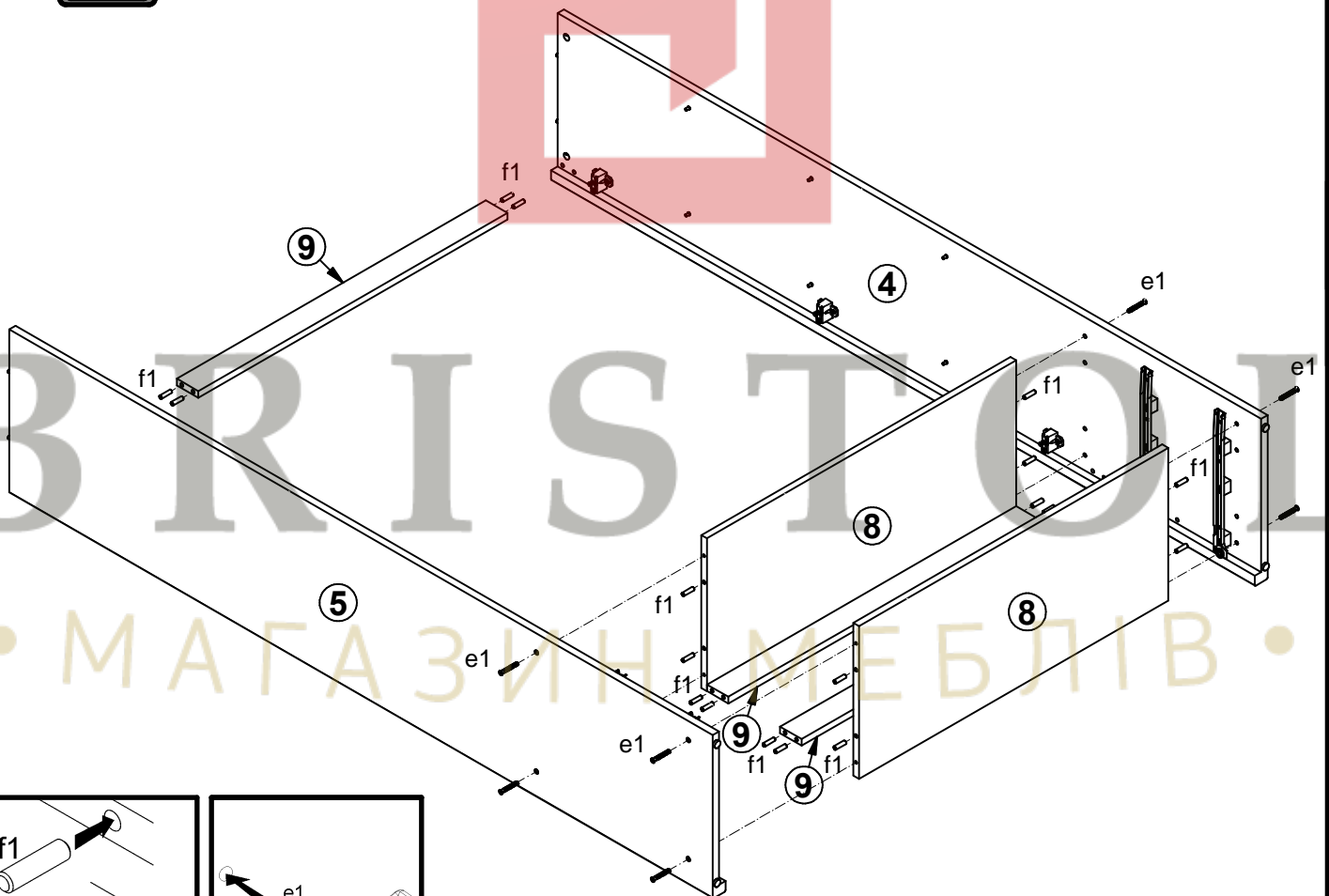

3

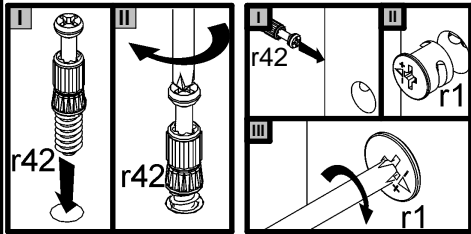
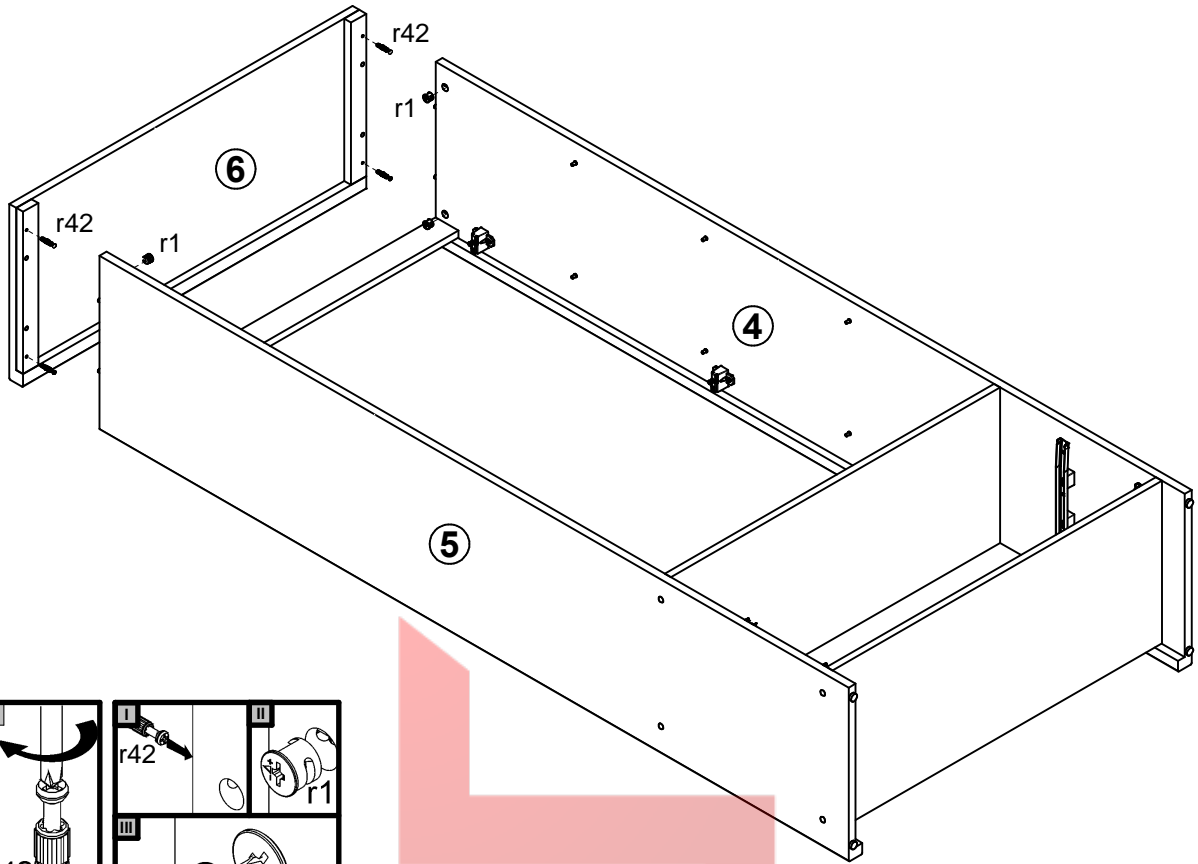

4

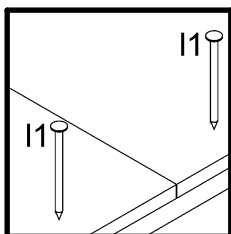
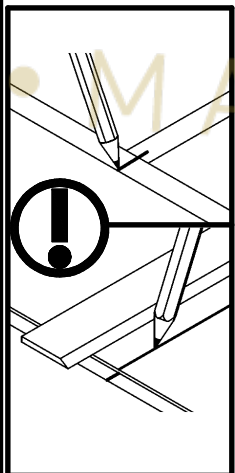
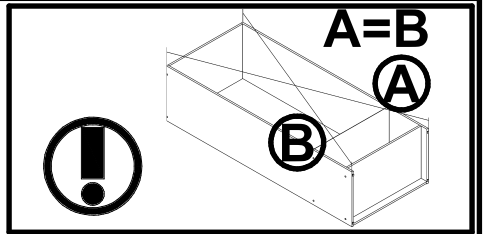
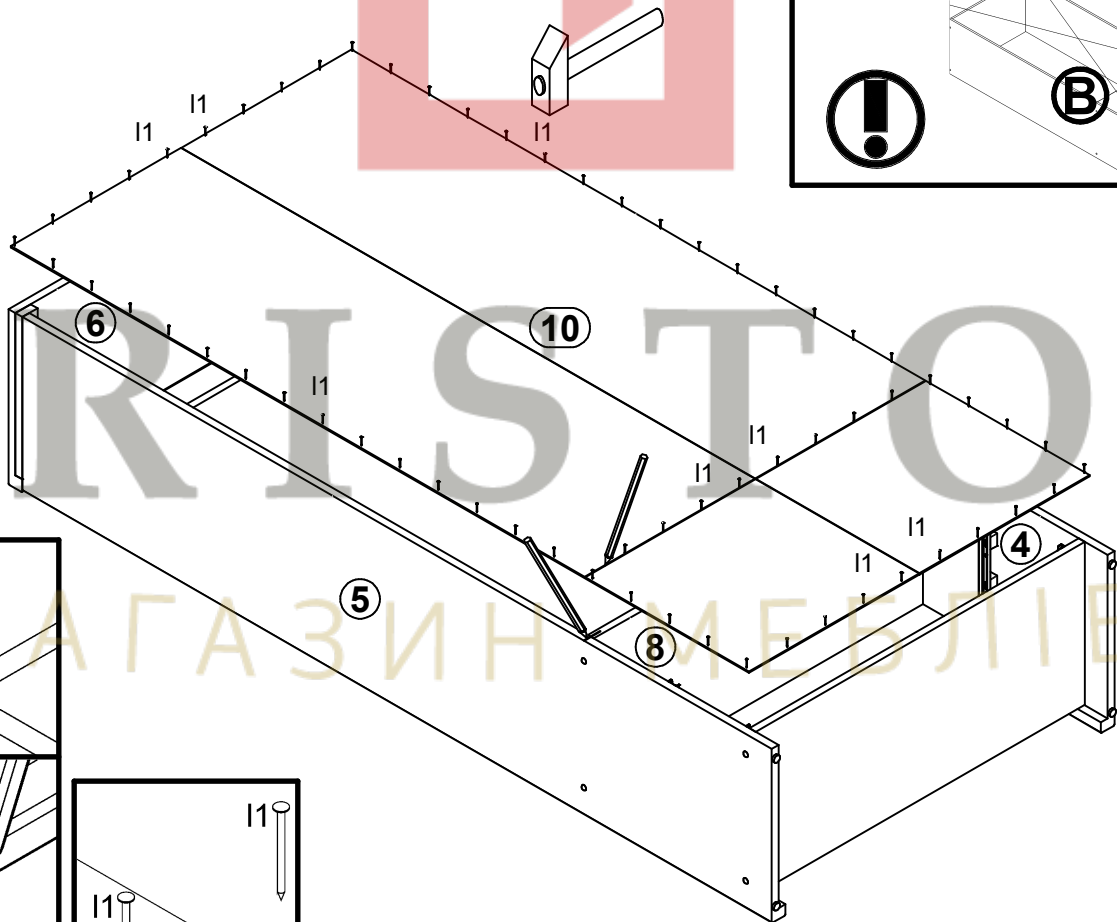

5

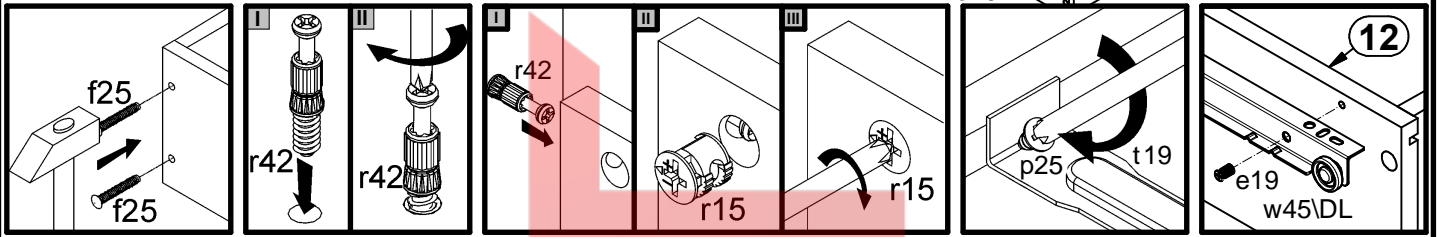
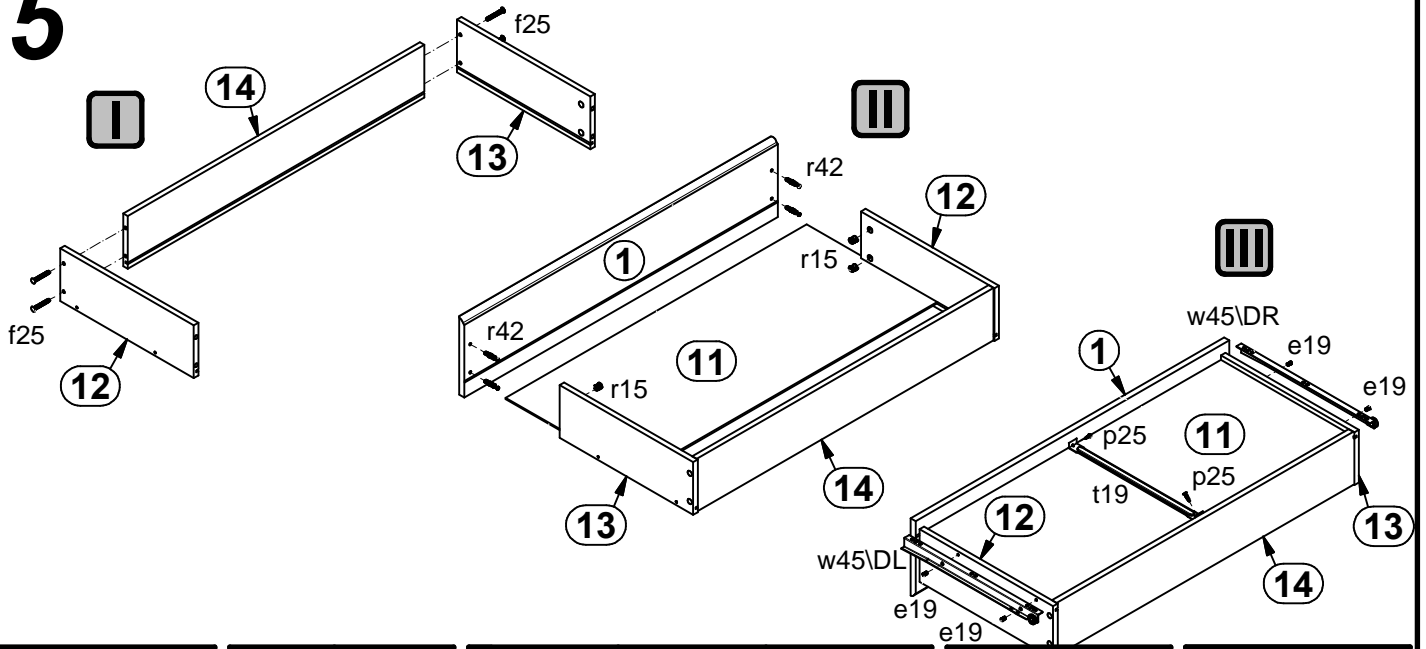

6

