

KASPIAN 2

REG1W2S

A	B	C	D	
1	S128-0004	482	176	4/5
2	S128-005 A	1468	479	5/5
3	S128-105	1964	396	1/5
4	S128-106	1964	396	1/5
5	S128-203-01	560	399	2/5
6	S128-304	523	370	2/5
7	S128-405	523	60	2/5
8	S128-501	521	345	3/5
9	S128-904	1935	553	1/5
10	S128-9905	440	348	1/5
11	BP-503	350	120	2/5
12	BP-504	350	120	2/5
13	ZP-5502	430	120	2/5

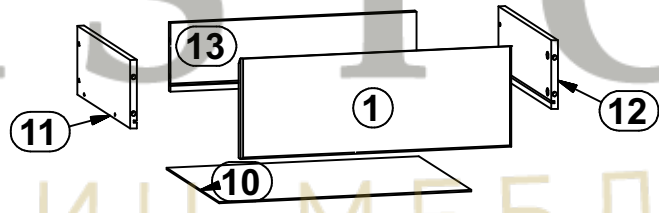
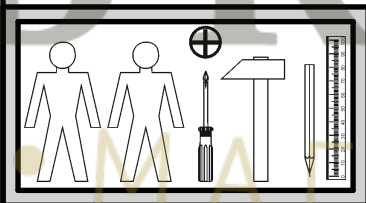
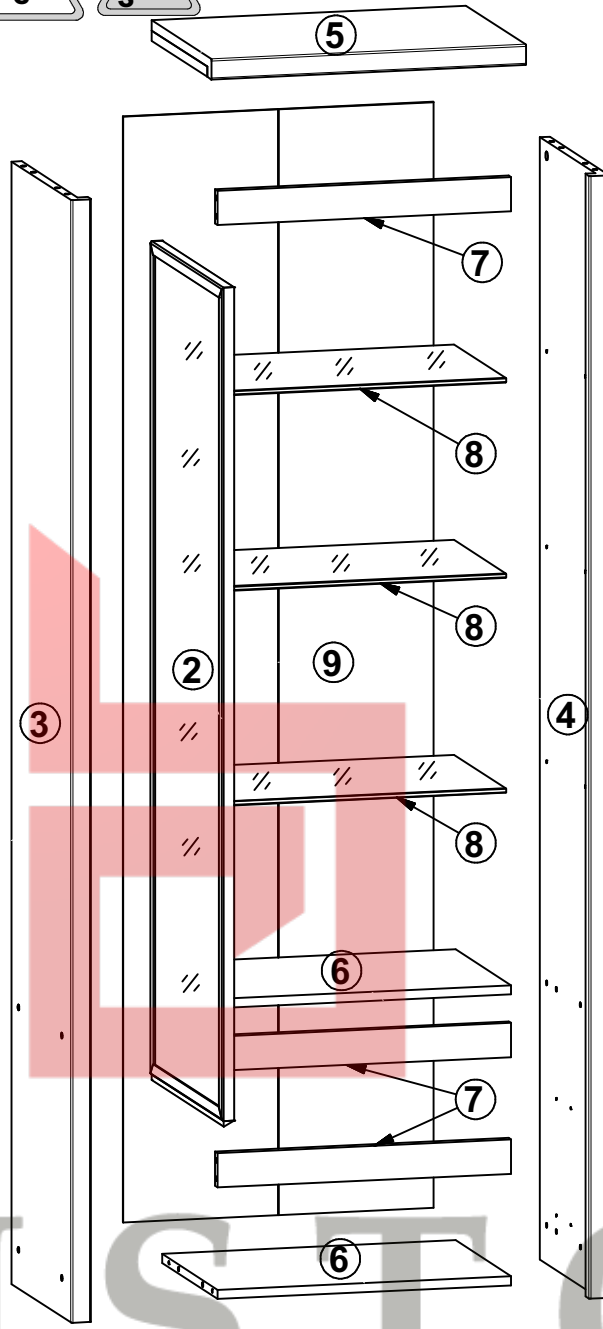
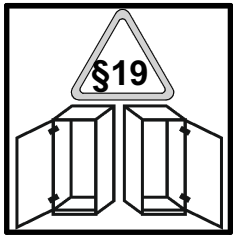
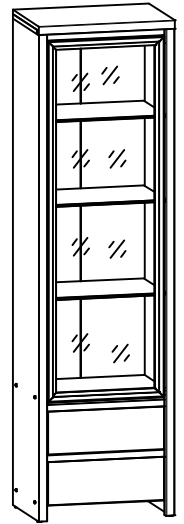

3x a1	3x b12	3x b44	12x d3 φ5x17 mm	8x e1 φ7x50 mm	12x e16 φ6x30 mm	8x e19 φ5x9 mm	6x e23 φ6,3x30 mm	24x f1 φ8x30 mm
8x f25 φ6,5x40 mm	4x k1	55x l1	12x r1 φ1,5x12mm #16	12x r42	12x w36 h=18 mm	2x w45\CL 350 mm	2x w45\CR 350 mm	2x w45\DL 350 mm
2x w45\DR 350 mm	1x z1	1x n26\1	1x p38 φ3,5x16 mm	8x s1	4x s2 ø16	3x s8 L26 mm	6x s4 L5	

1 

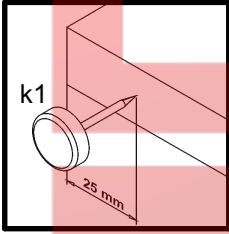
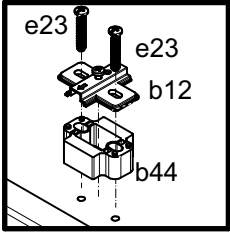
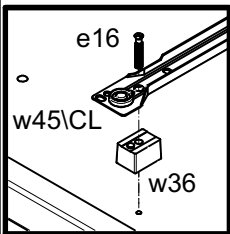
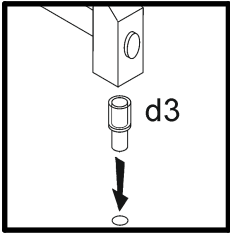
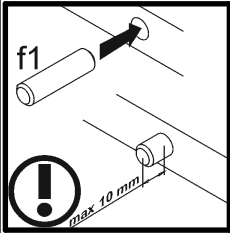
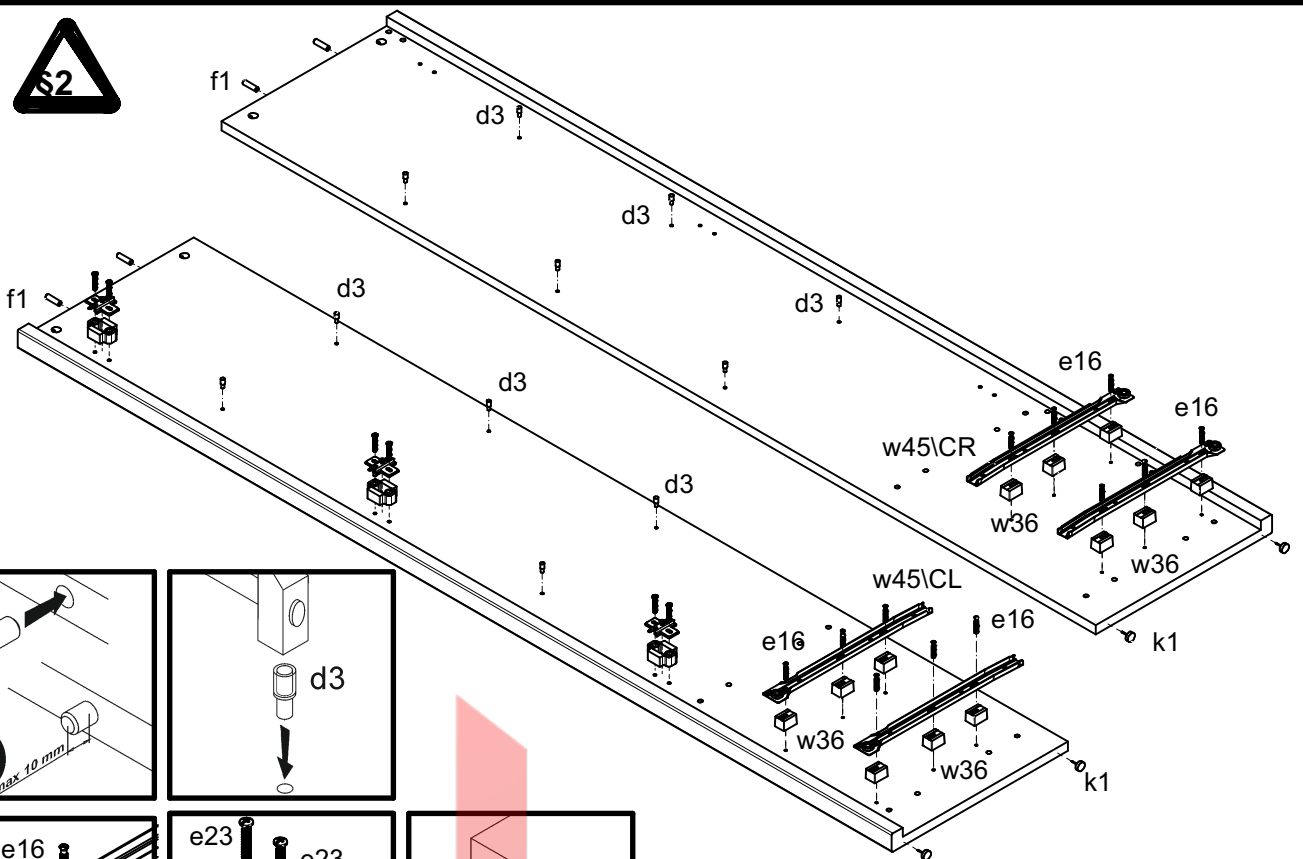

2 

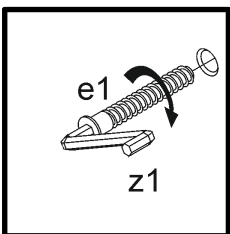
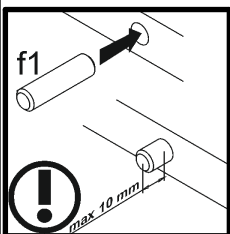
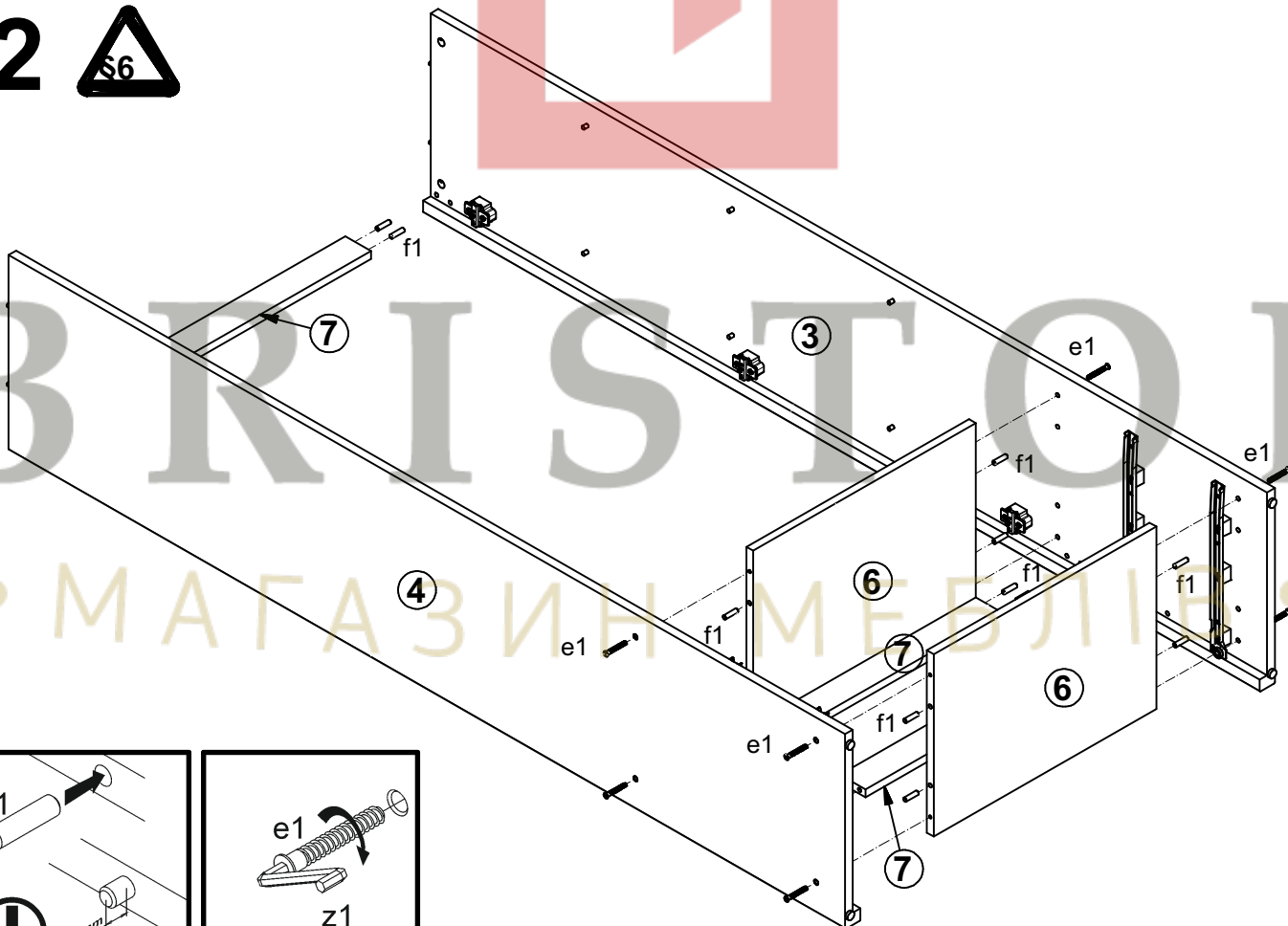

3

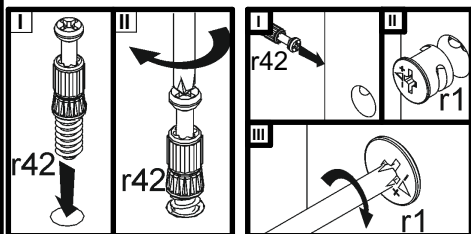
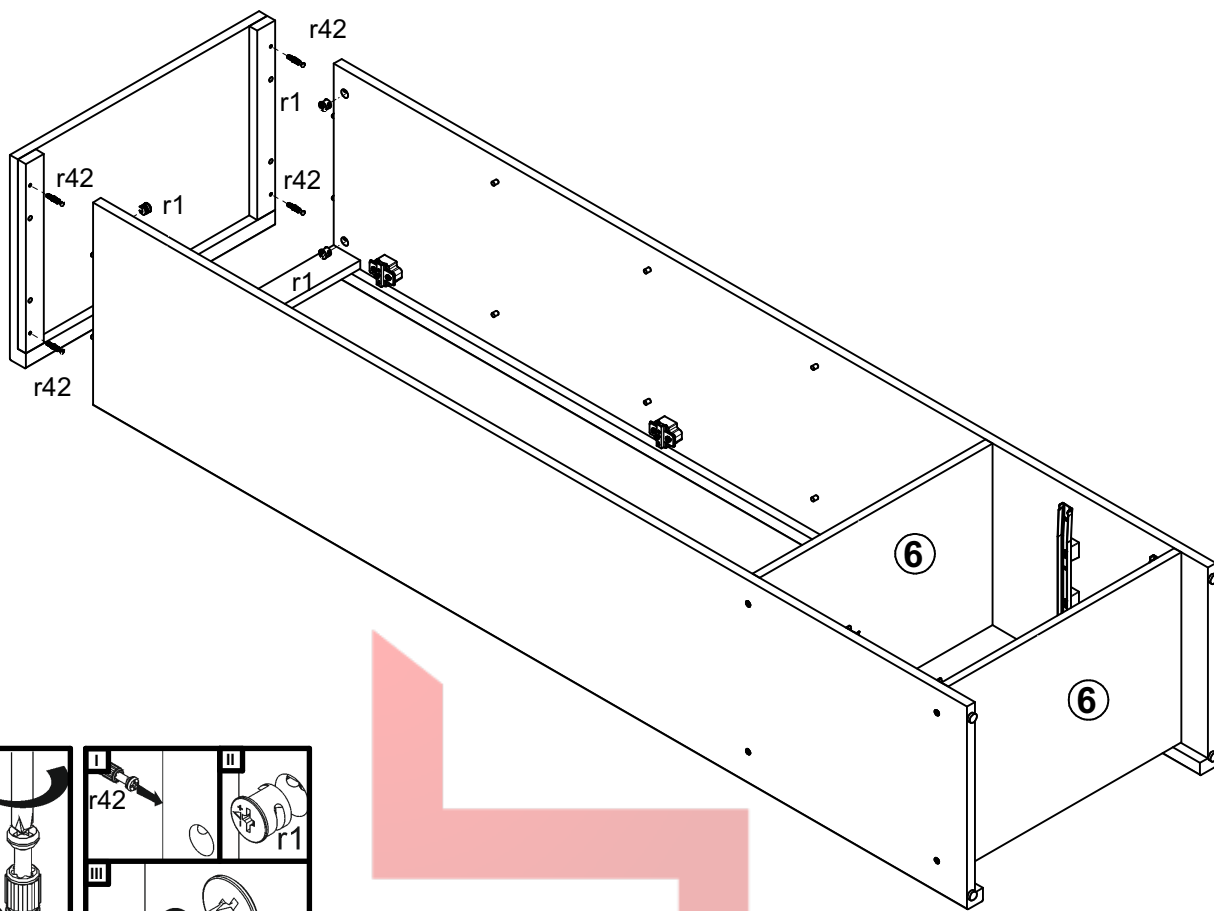

4

