

A	B	C	D	
1	S162-0006	494	176	2/2
2	S162-0016	494	200	2/2
3	S162-1112	477	371	1/2
4	S162-1113	477	371	1/2
5	S162-2203	522	397	1/2
6	S162-4404	488	60	1/2
7	S162-4405	488	60	1/2
8	S162-4408	488	60	1/2
9	S162-9904	461	355	1/2
10	S162-9909	442	256	1/2
11	ZS3-509	350	120	1/2
12	ZS3-510	350	120	1/2
13	ZS3-5506	439	120	1/2
14	Lh-412	412	14	1/2

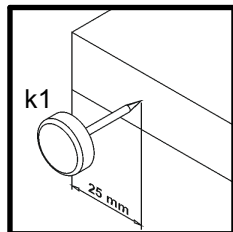

2 

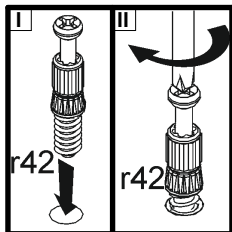
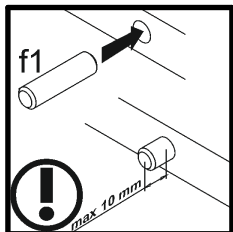
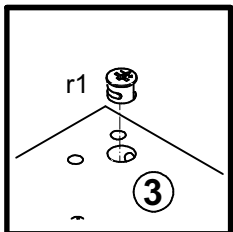
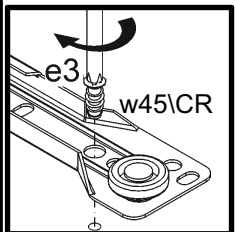
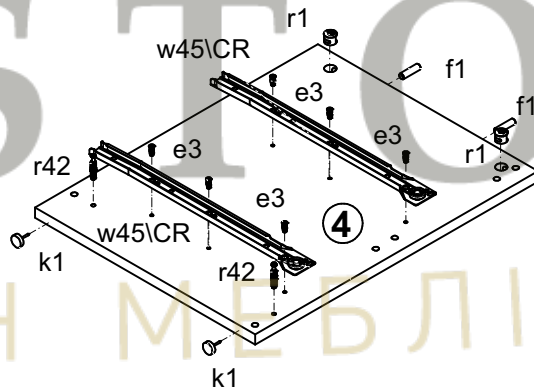
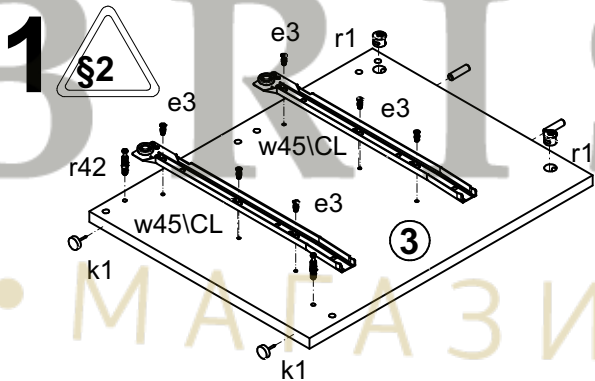
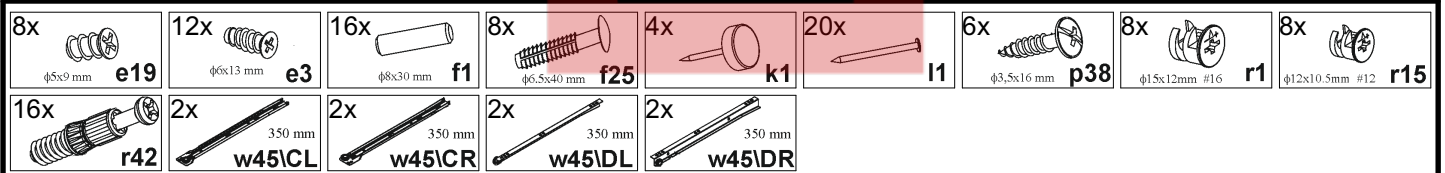
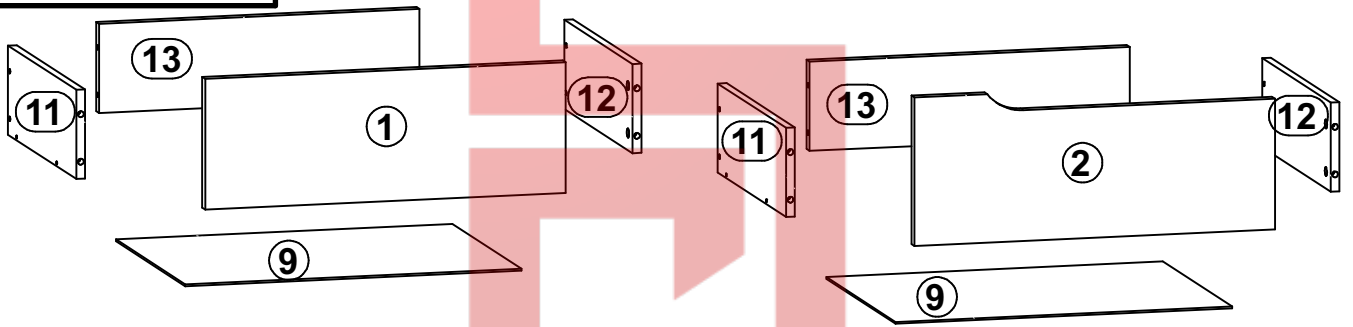
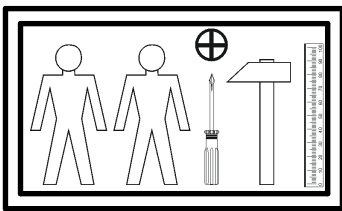
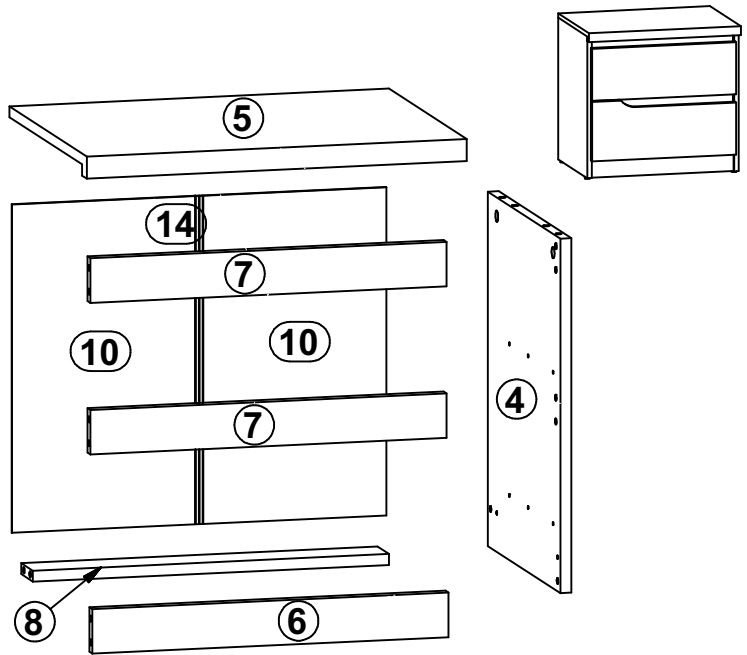
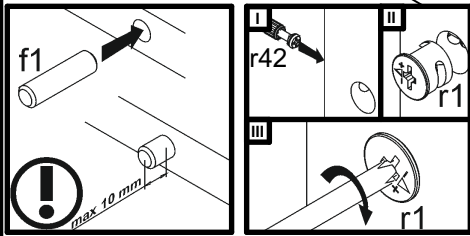
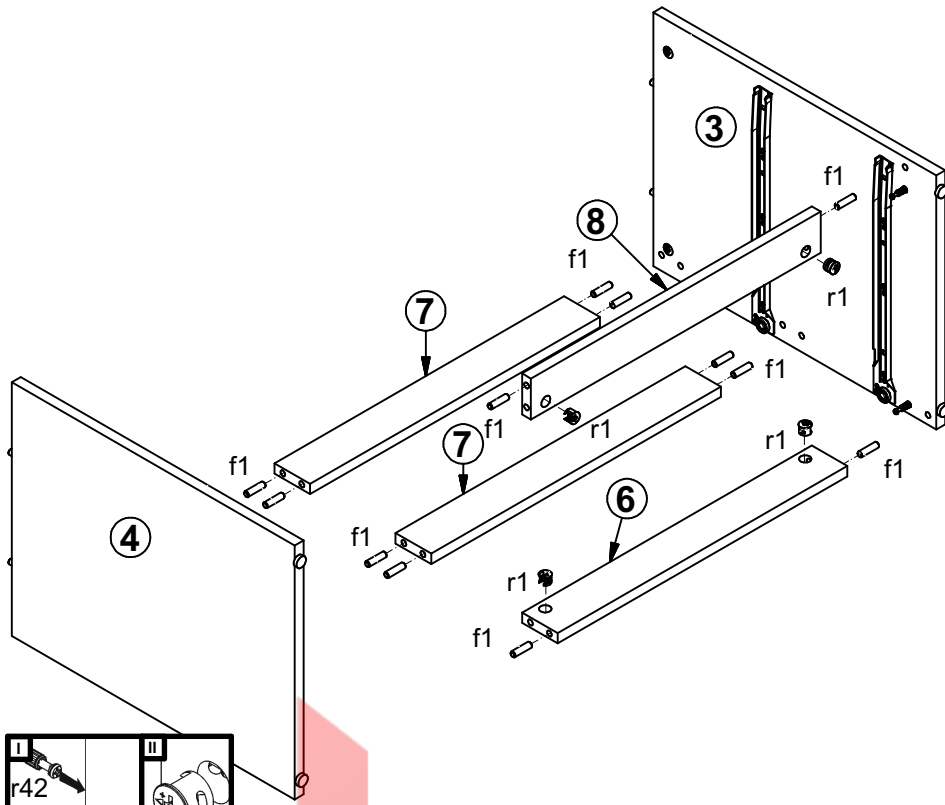

3

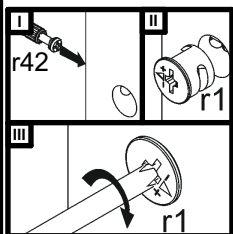
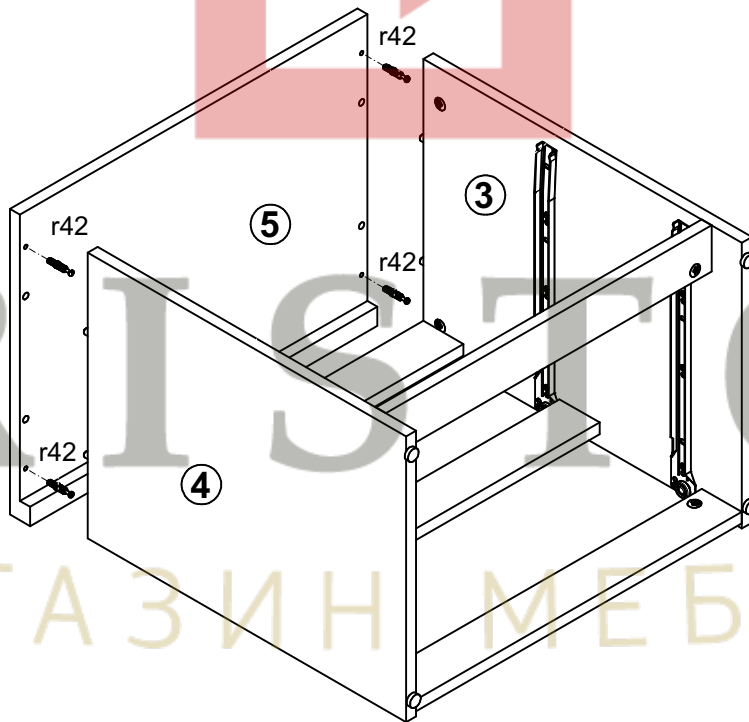

4

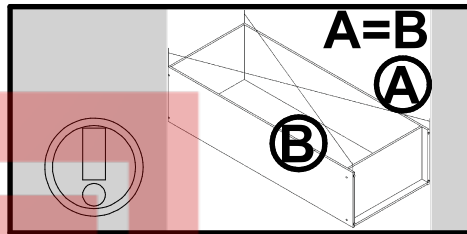
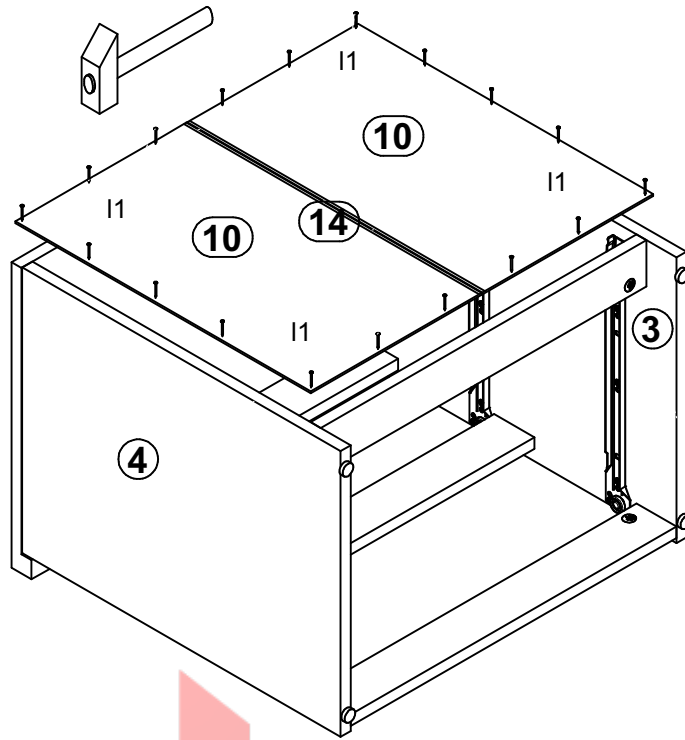

5

