

| A | B | C | D |
|----|-----------|------|----------|
| 1 | S162-0024 | 320 | 436 2/2 |
| 2 | S162-0025 | 320 | 436 2/2 |
| 3 | S162-1129 | 400 | 435 1/2 |
| 4 | S162-1130 | 400 | 435 1/2 |
| 5 | S162-1131 | 325 | 435 1/2 |
| 6 | S162-1132 | 325 | 435 1/2 |
| 7 | S162-2210 | 1363 | 461 1/2 |
| 8 | S162-3321 | 1329 | 435 1/2 |
| 9 | S162-3322 | 458 | 434 1/2 |
| 10 | S162-4409 | 1329 | 60 1/2 |
| 11 | S162-4421 | 417 | 60 1/2 |
| 12 | S162-9922 | 350 | 1354 1/2 |

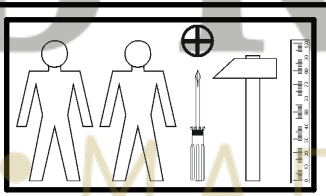

| | | | | | | | | |
|----------------|---------------------|--------------------------|----------------------------|---------------------------|--------------|---------------|-----------------------------|--------------------------------|
| 4x a68 | 4x b19 | 4x d1 ∅5x17 mm | 8x e2 ∅6.3x13 mm | 30x f1 ∅8x30 mm | 5x k1 | 45x l1 | 8x p51 ∅6.5x15 mm | 16x r1 ∅15x12 mm #16 |
| 16x r42 | 4x s2 ∅16 | | | | | | | |

1

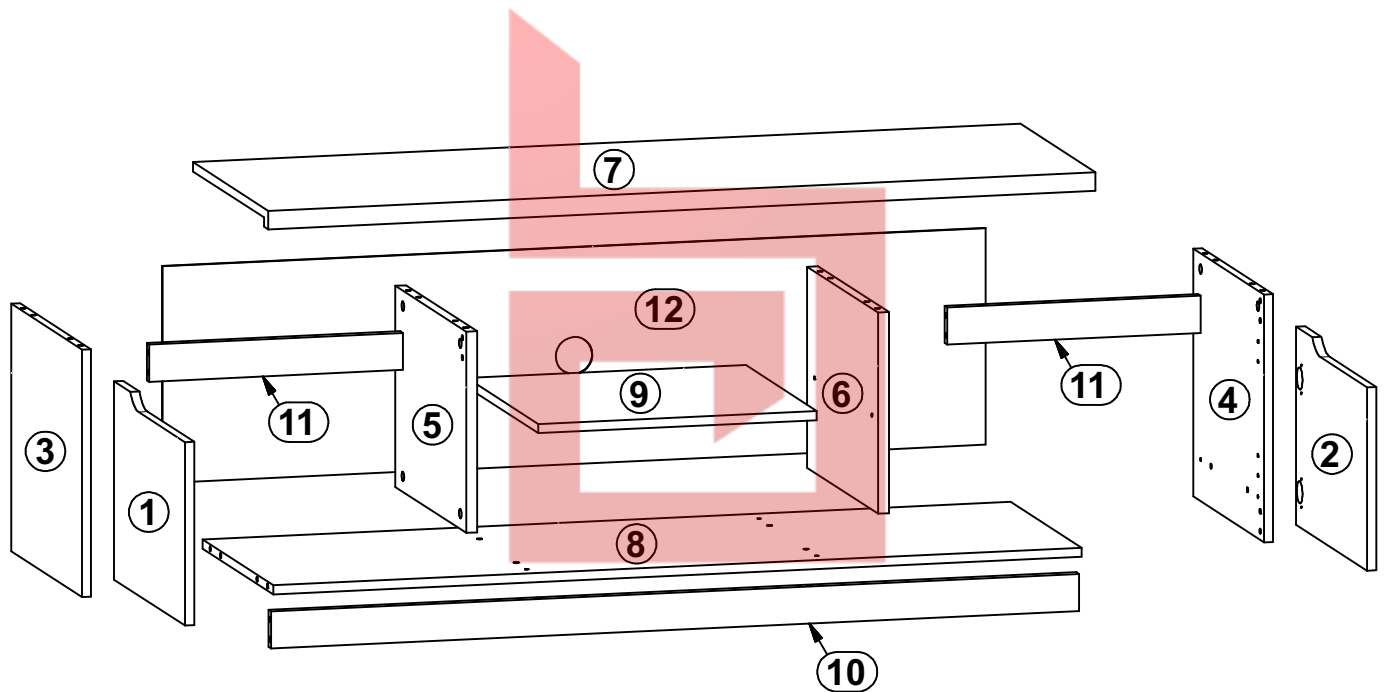
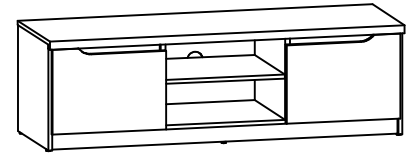
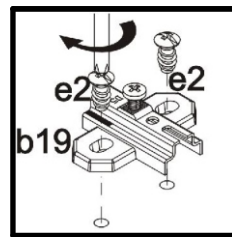
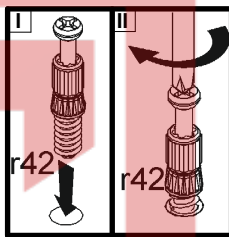
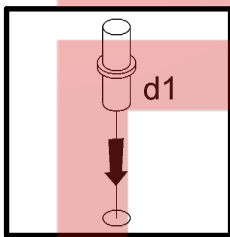
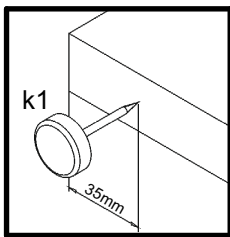
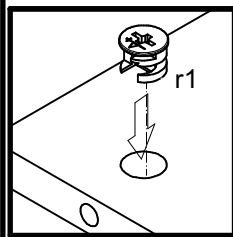
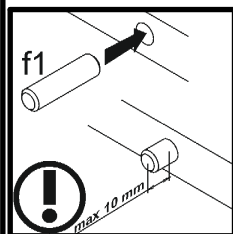
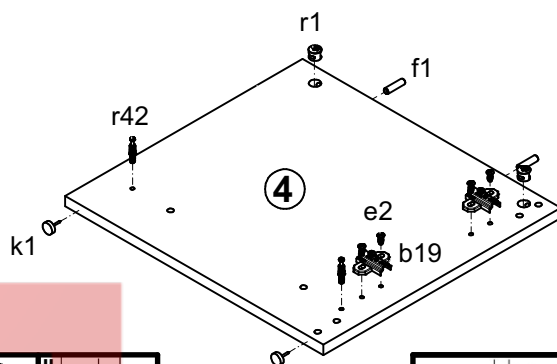
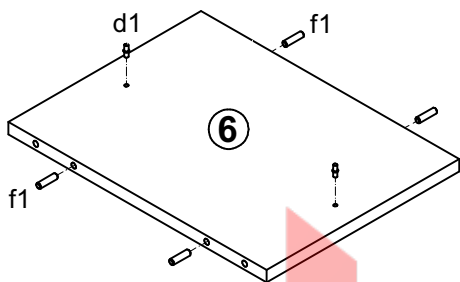
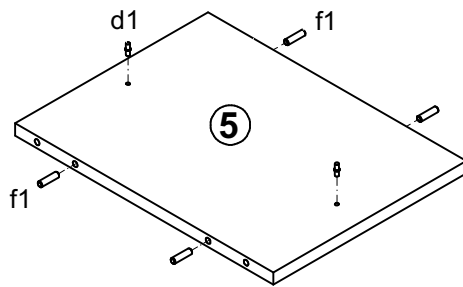
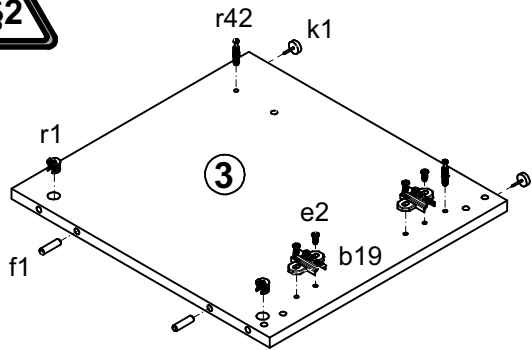

2

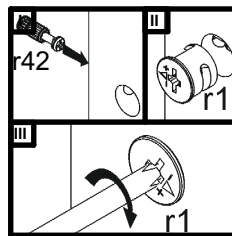
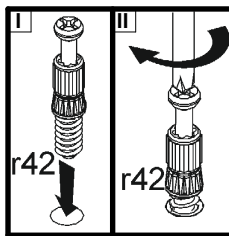
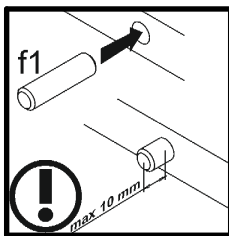
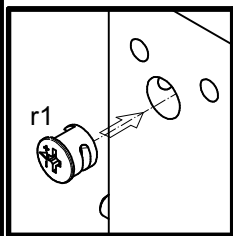
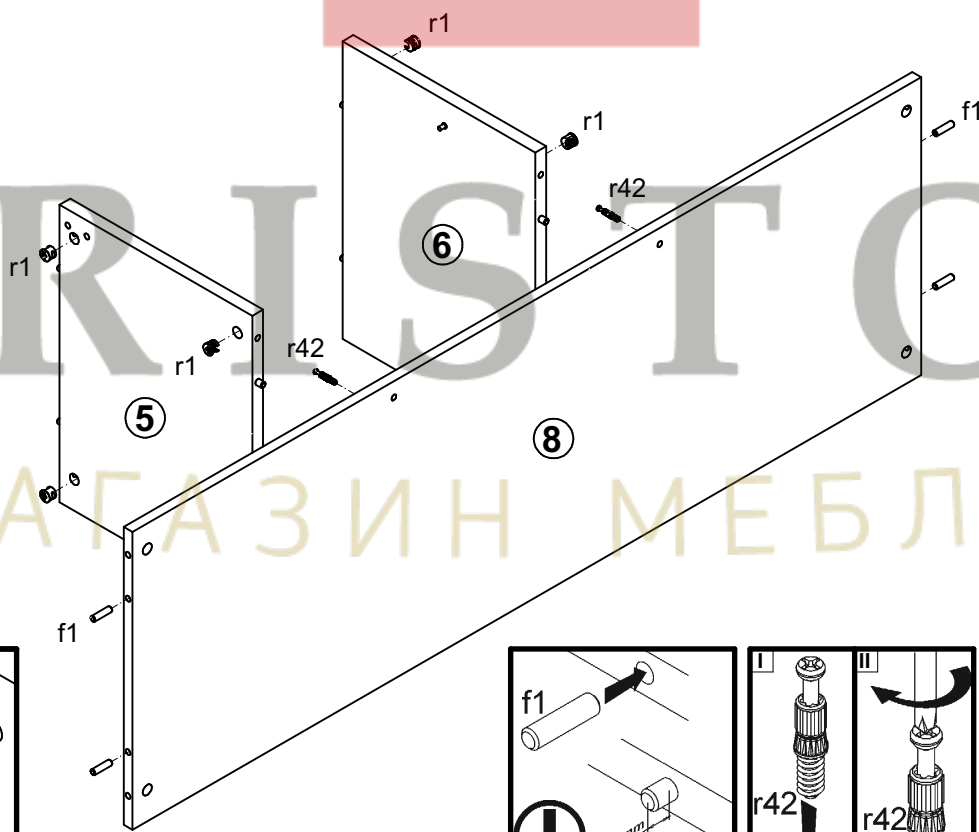

3

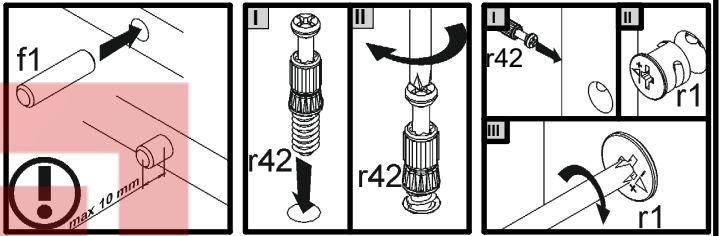
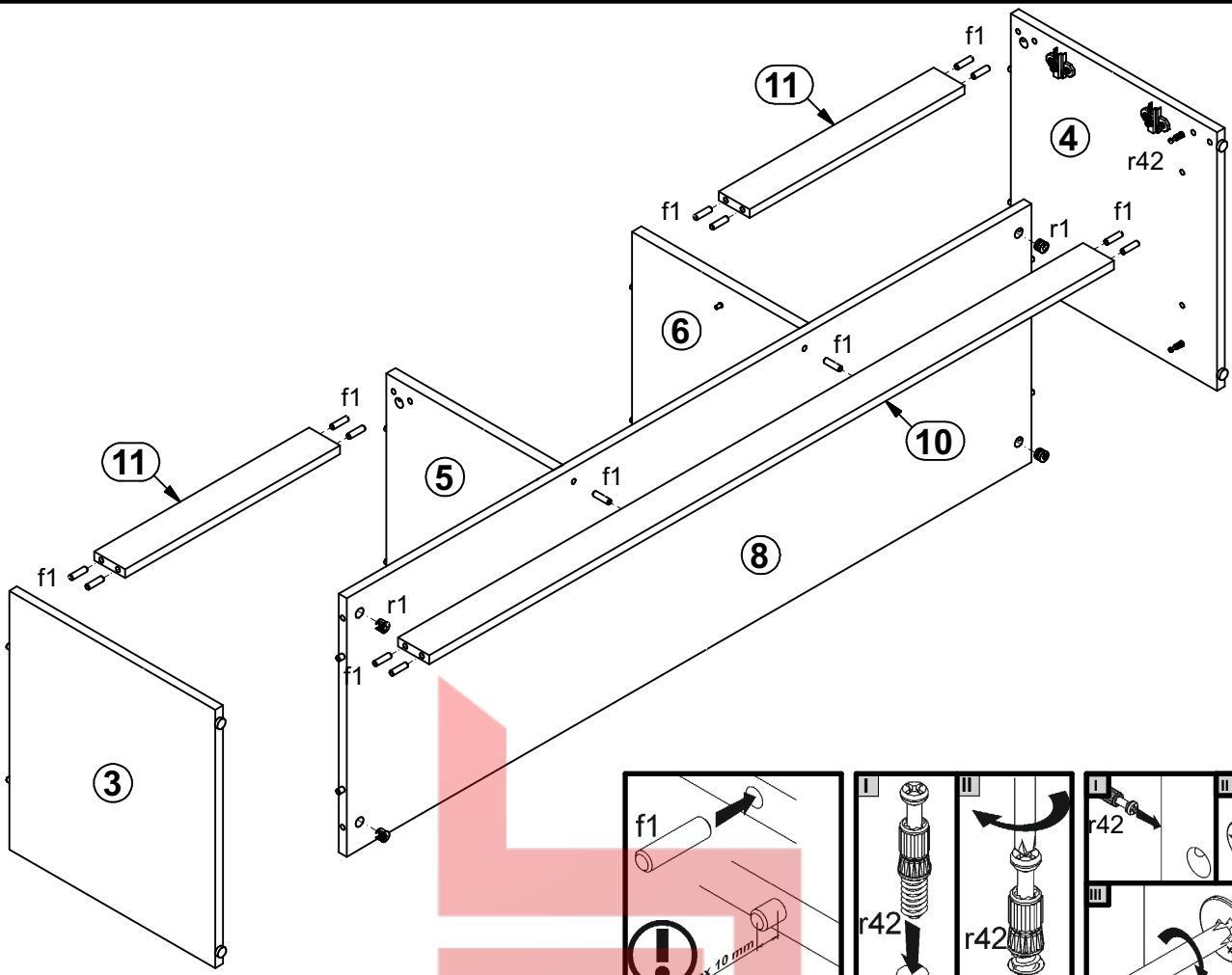

4

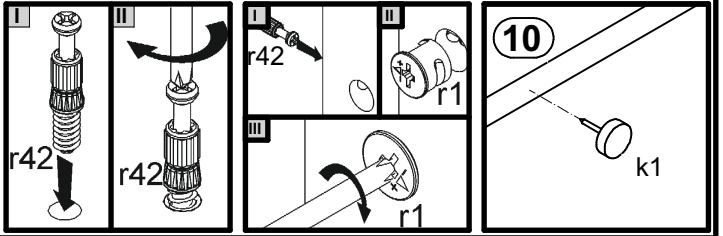
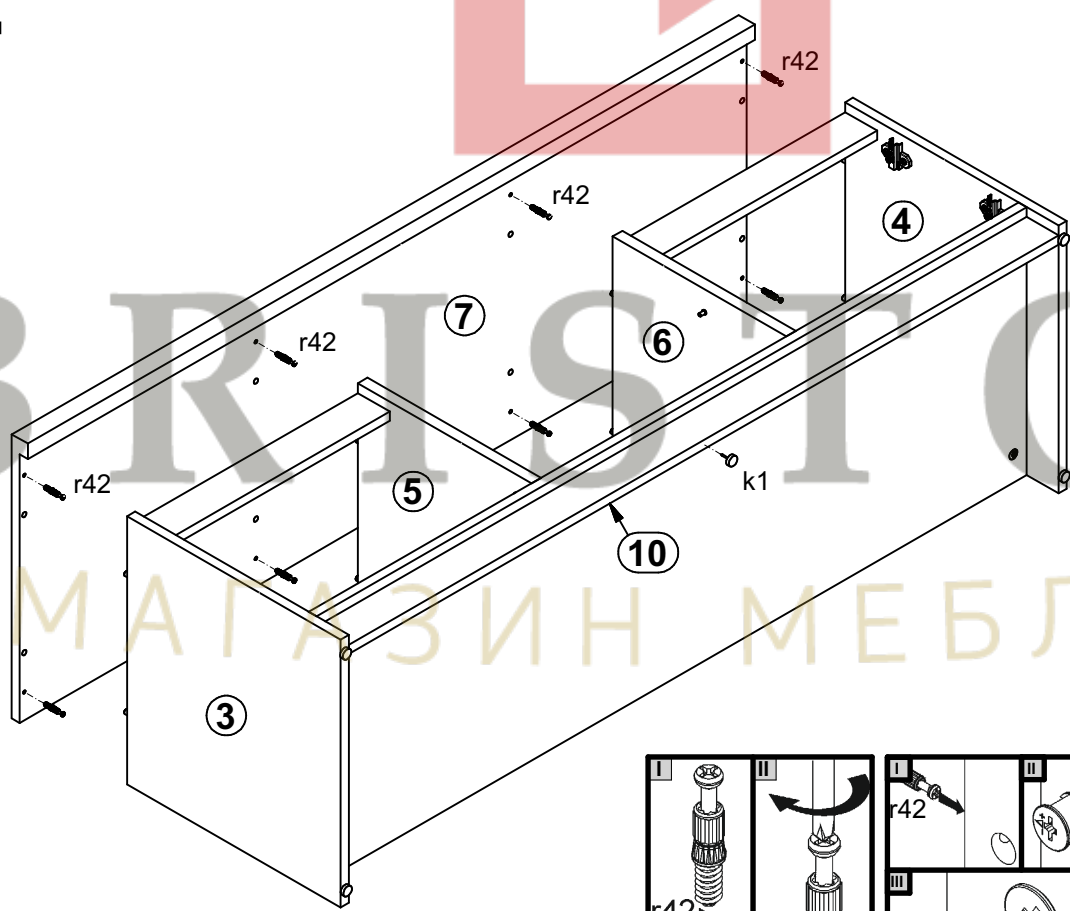

5

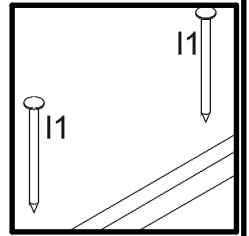
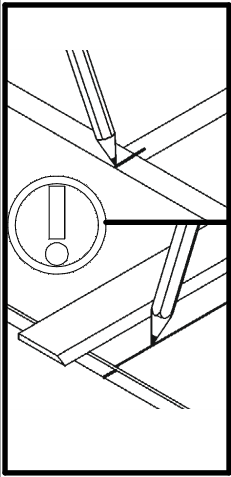
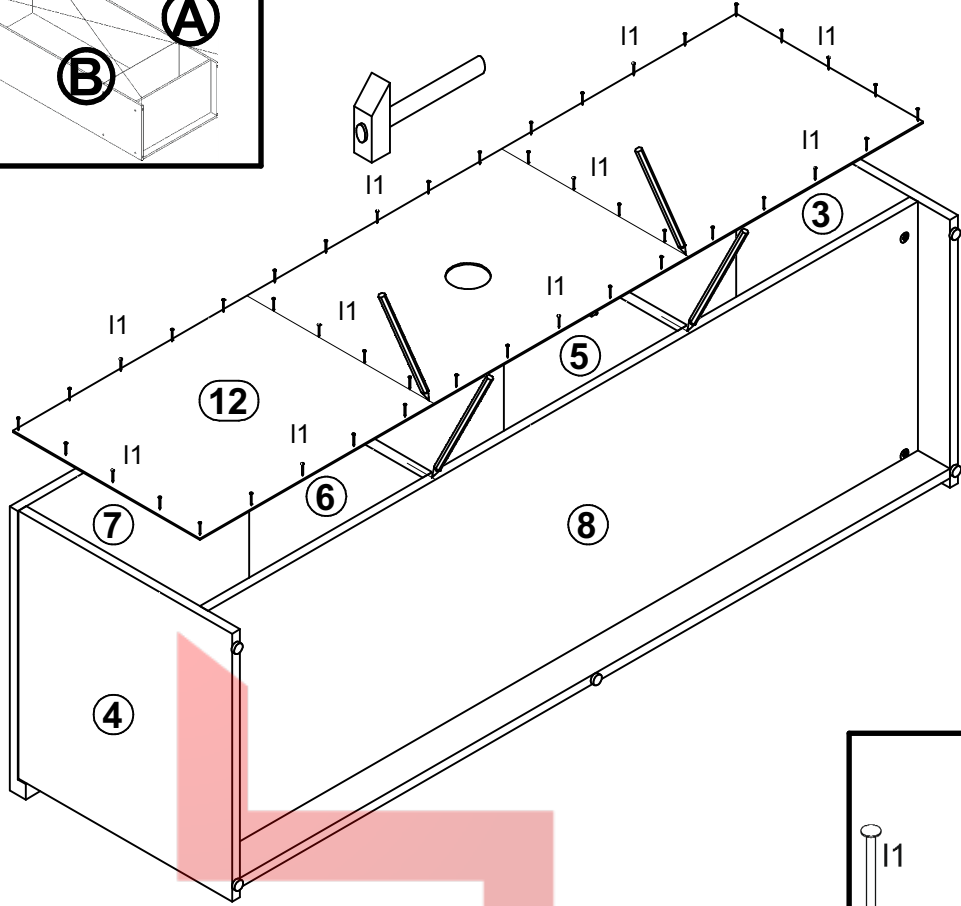
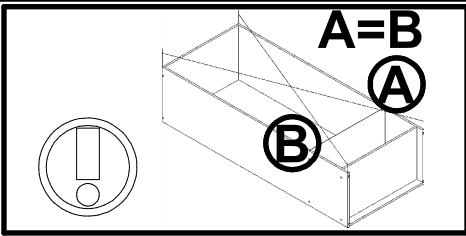

6

