

ВУШЕР

Комод **КОМ 4S_90**

A	B	C	D	
1	S154-211	900	430	1/3
2	S154-212	900	430	1/3
3	S154-118	878	430	2/3
4	S154-513-01	350	160	2/3
5	S154-514-01	350	160	2/3
6	S154-517-01	827	160	2/3
7	S154-915	842	349	2/3
8	S154-916	888	438	2/3
9	LH-877	877	14	2/3
10	S154-017	896	224	3/3
11	S154-018	896	224	3/3
12	S154-019	896	224	3/3
13	S154-119	878	430	2/3

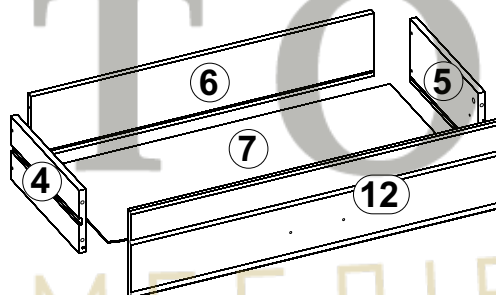
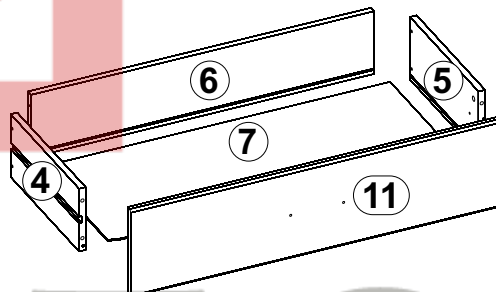
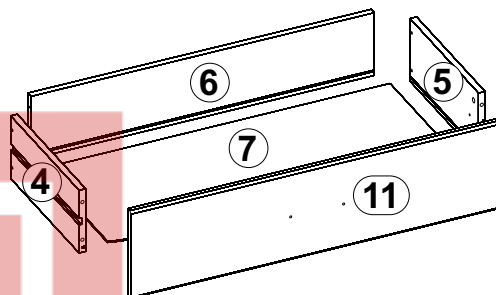
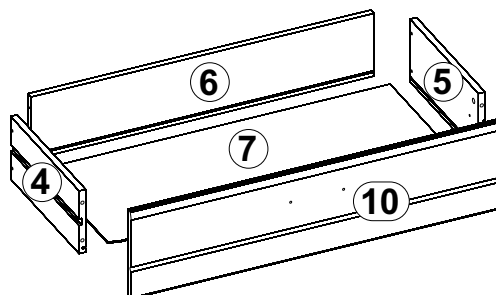
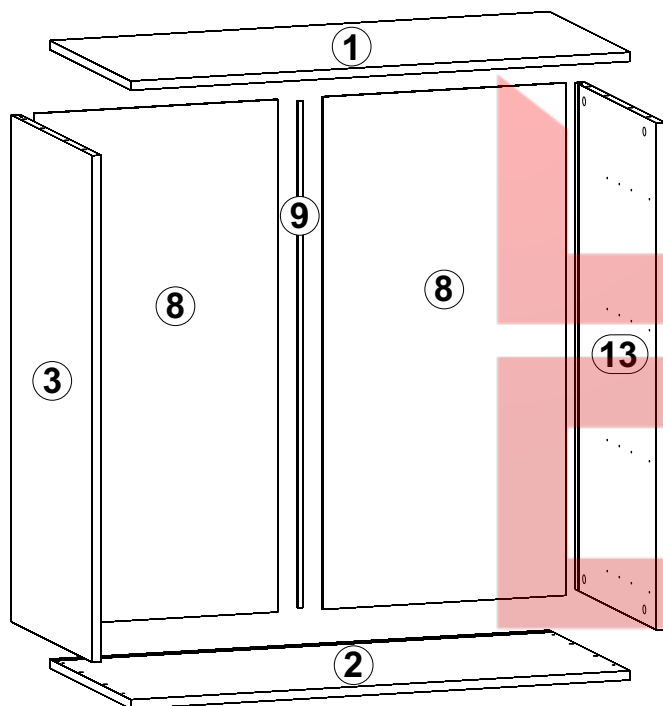
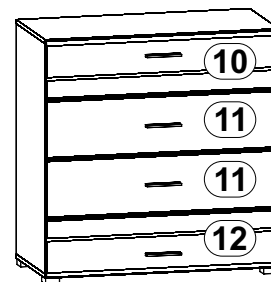
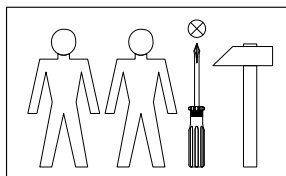

4x c253\3	16x $\phi 5 \times 50$ mm e32	8x $\phi 8 \times 30$ mm f1	8x M4x12 mm j3	4x k55	10x l2	32x $\phi 3,5 \times 13$ mm p1	8x $\phi 4 \times 35$ mm p6
8x $\phi 4 \times 30$ mm p9	8x $\phi 1,5 \times 12$ mm #16 r1	16x $\phi 12 \times 10,5$ mm #12 r15	24x r42	2x $\phi 16$ s2	8x 310 mm w4	1x n26\1	1x $\phi 3,5 \times 16$ mm p38
8x $\phi 3,5 \times 16$ mm p25	4x 333 mm t19						

1

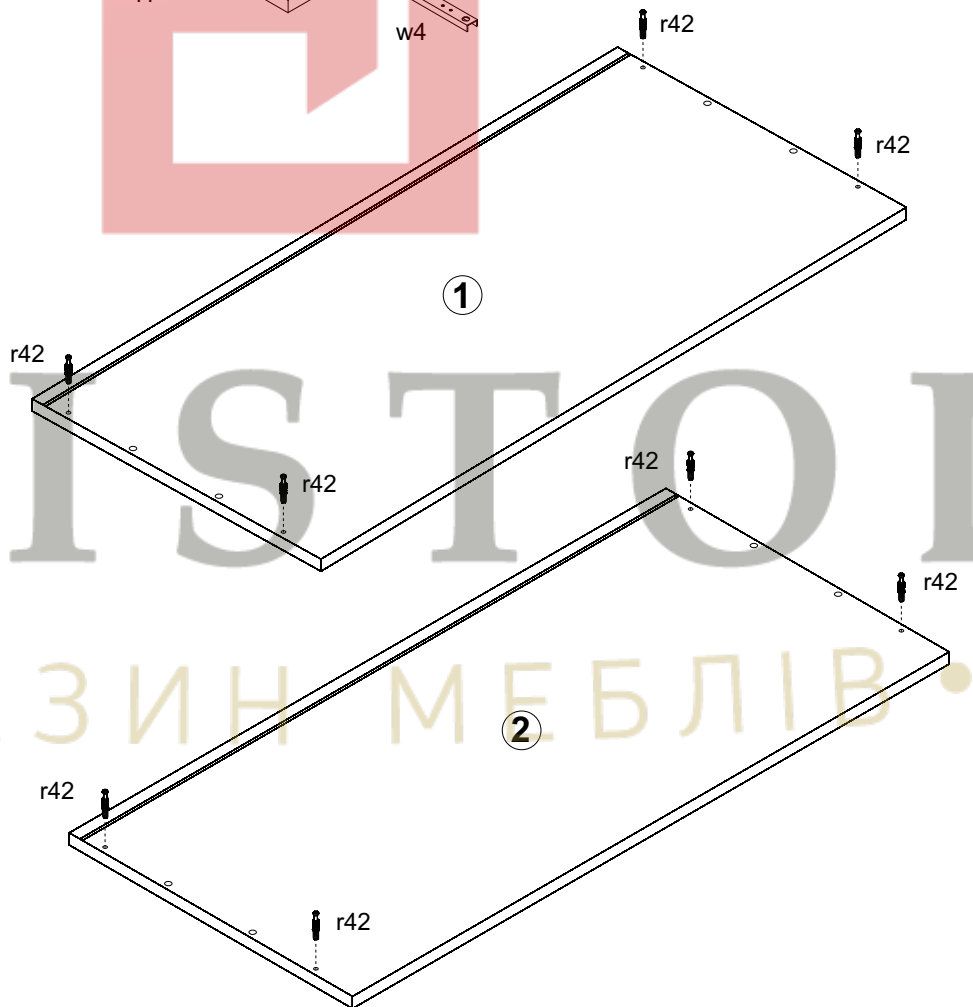
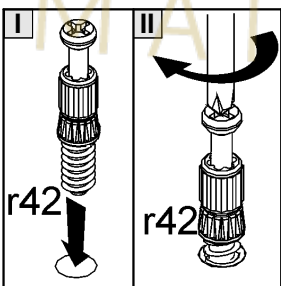
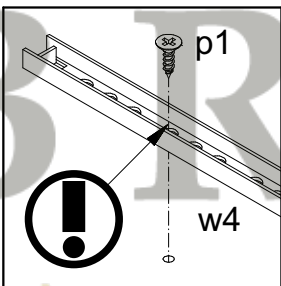
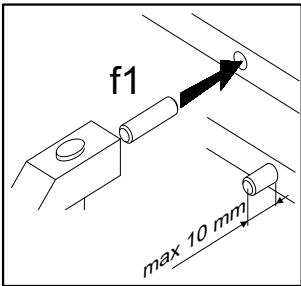
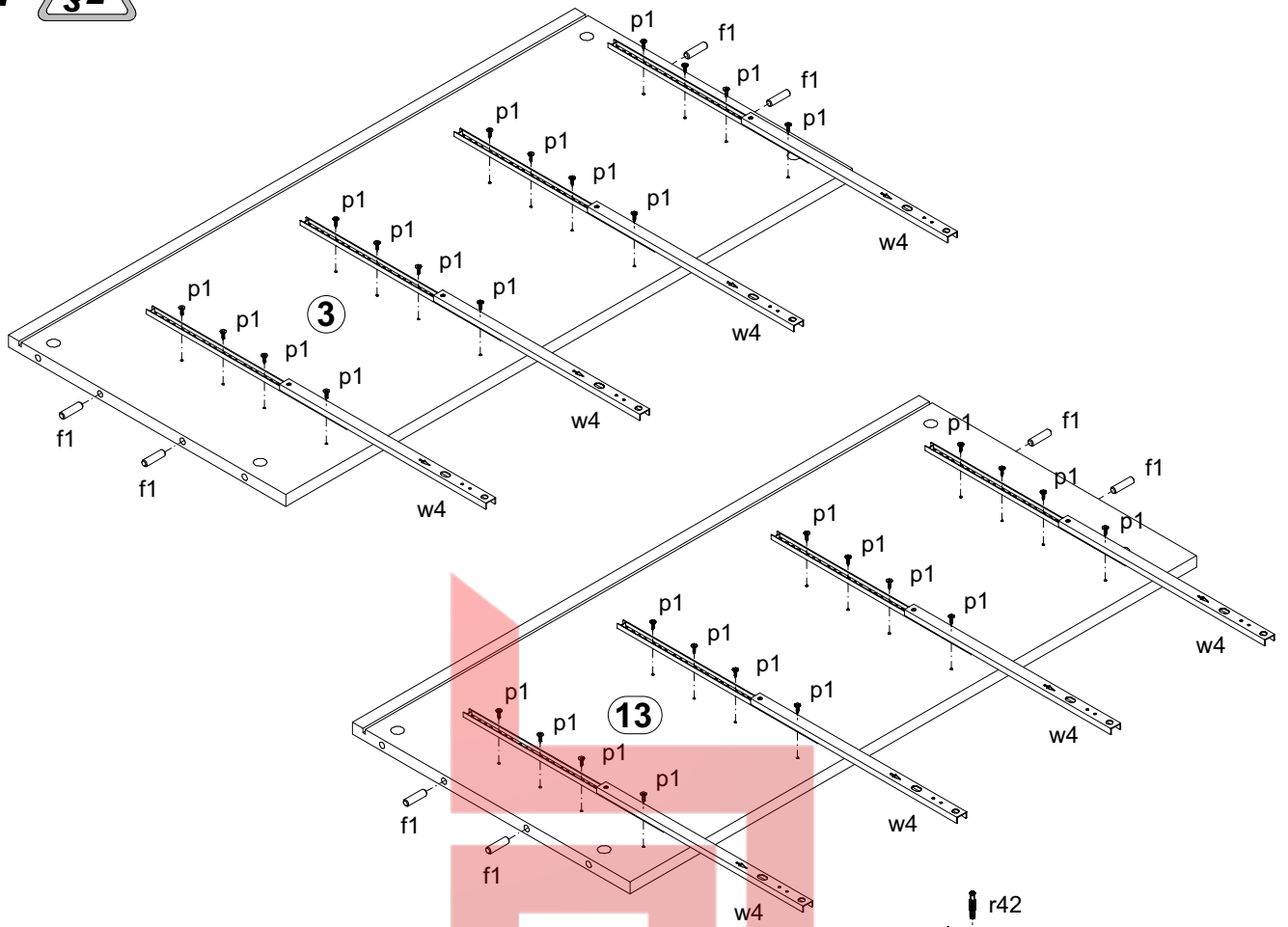

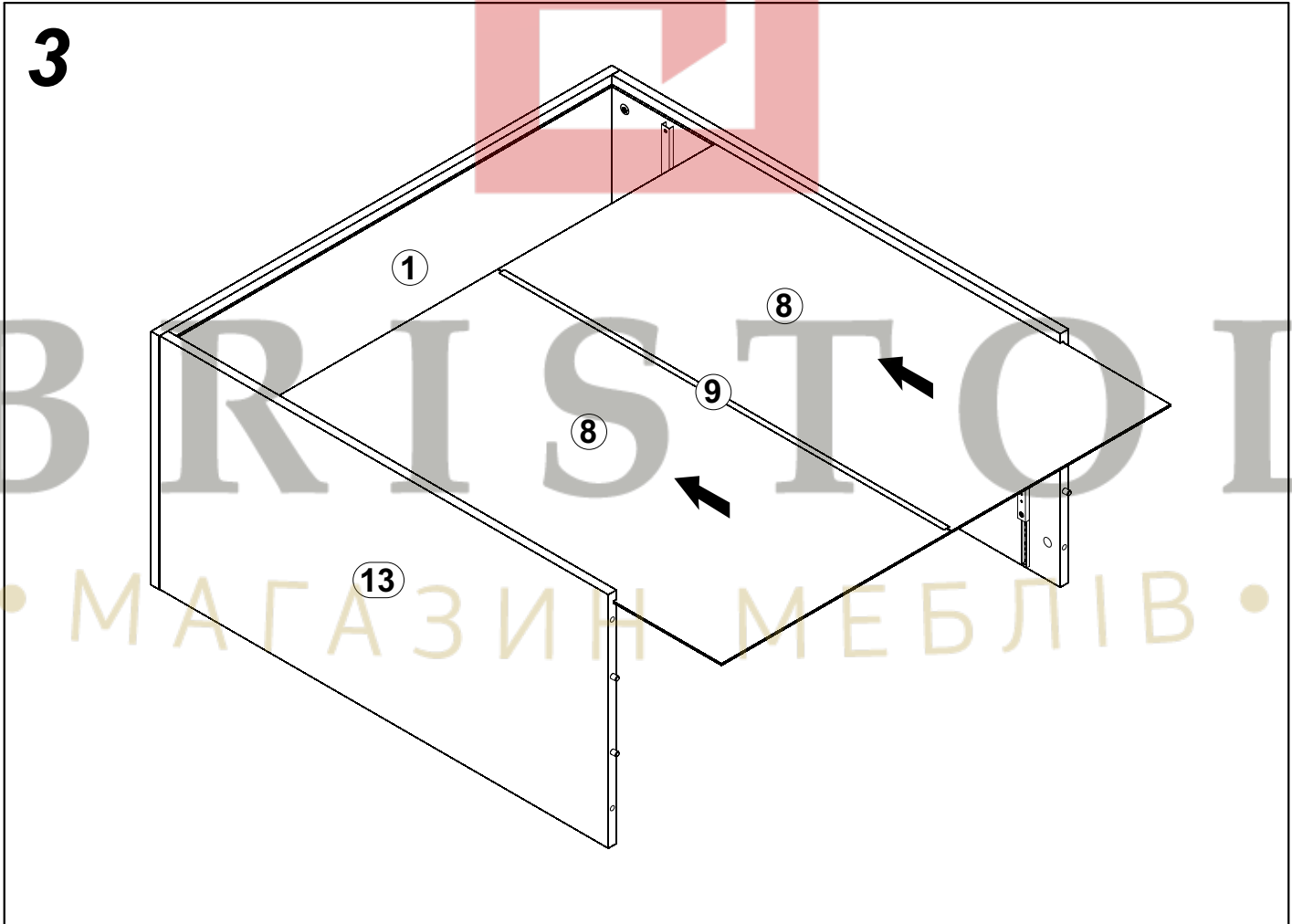
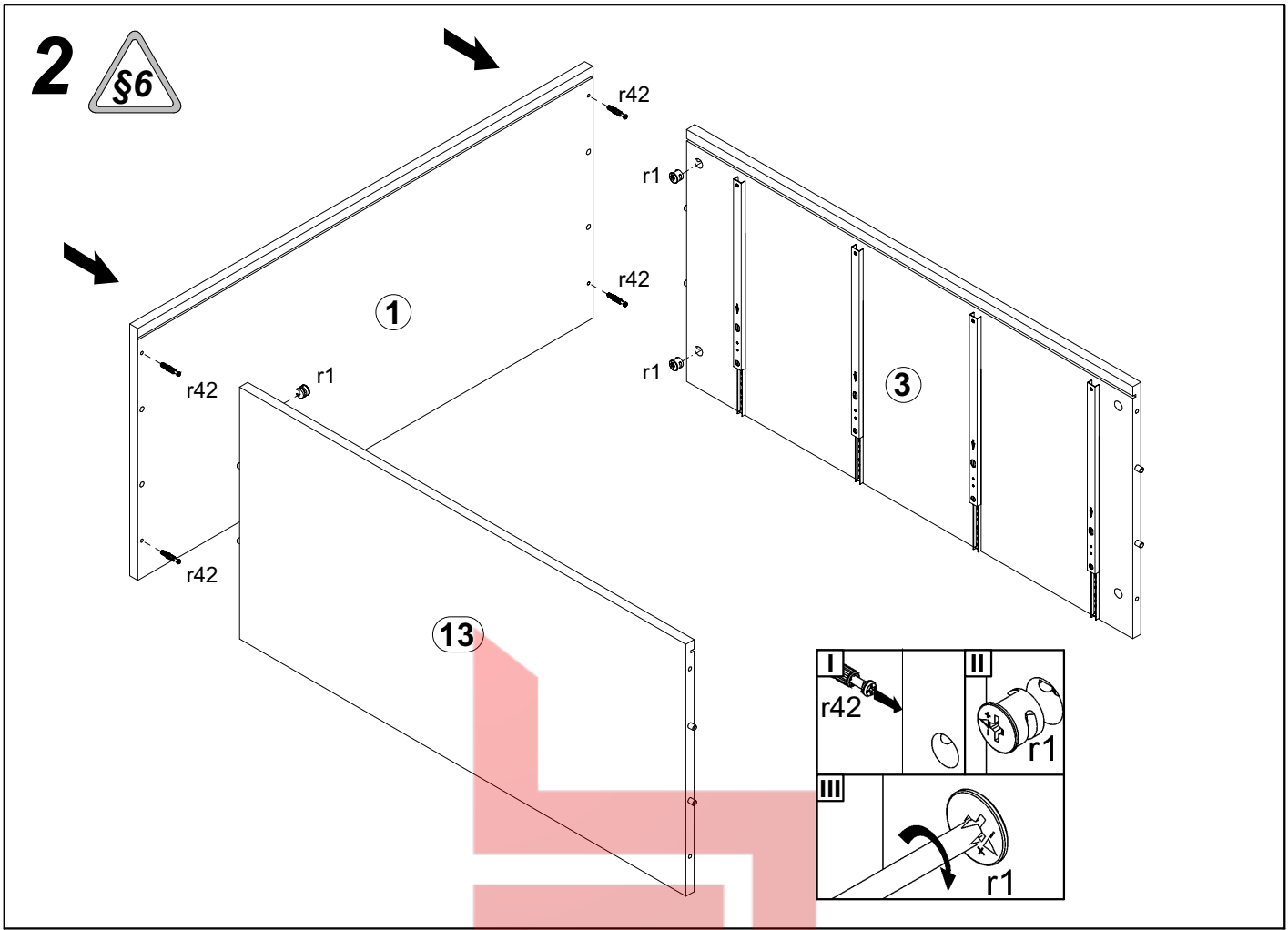

4

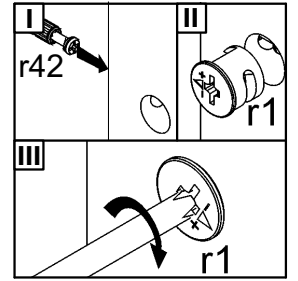
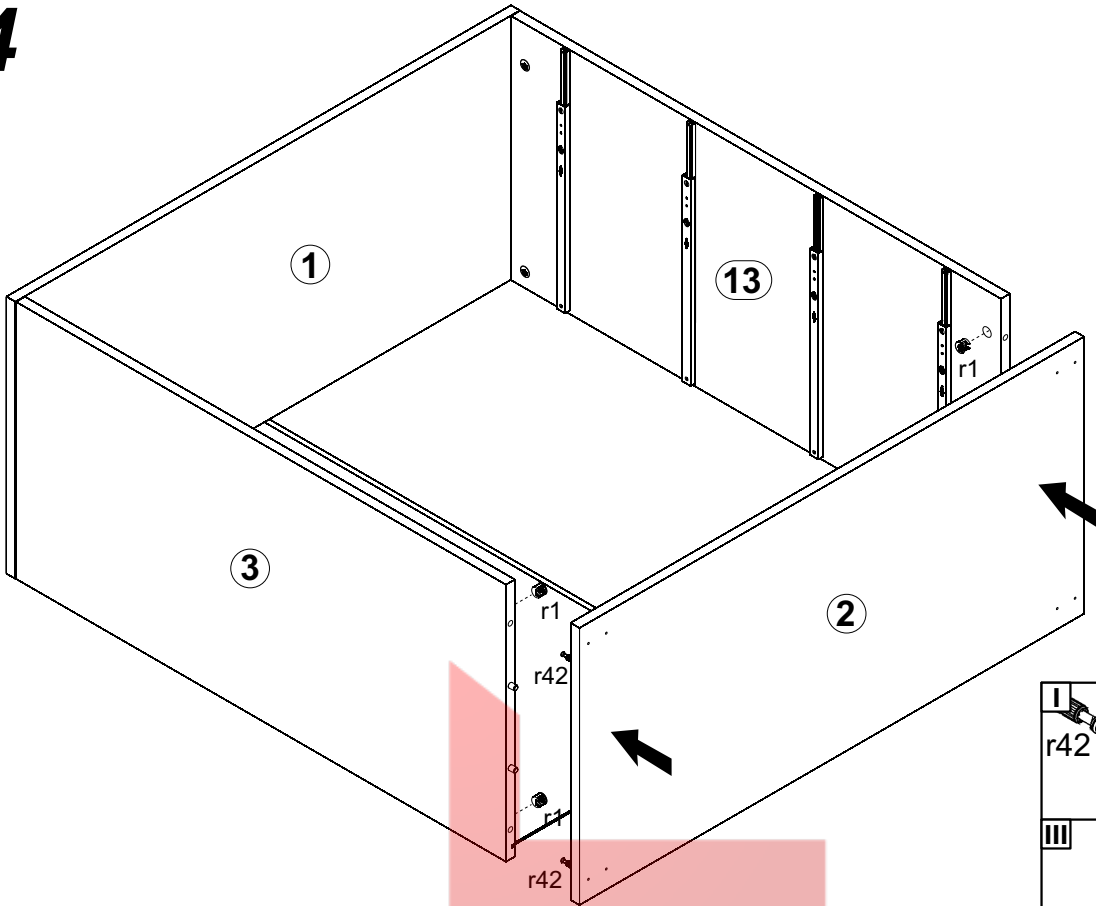

5

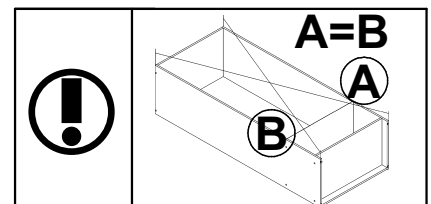
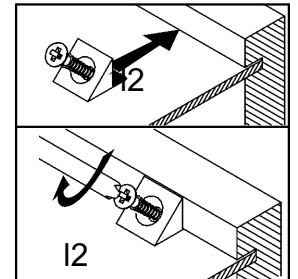
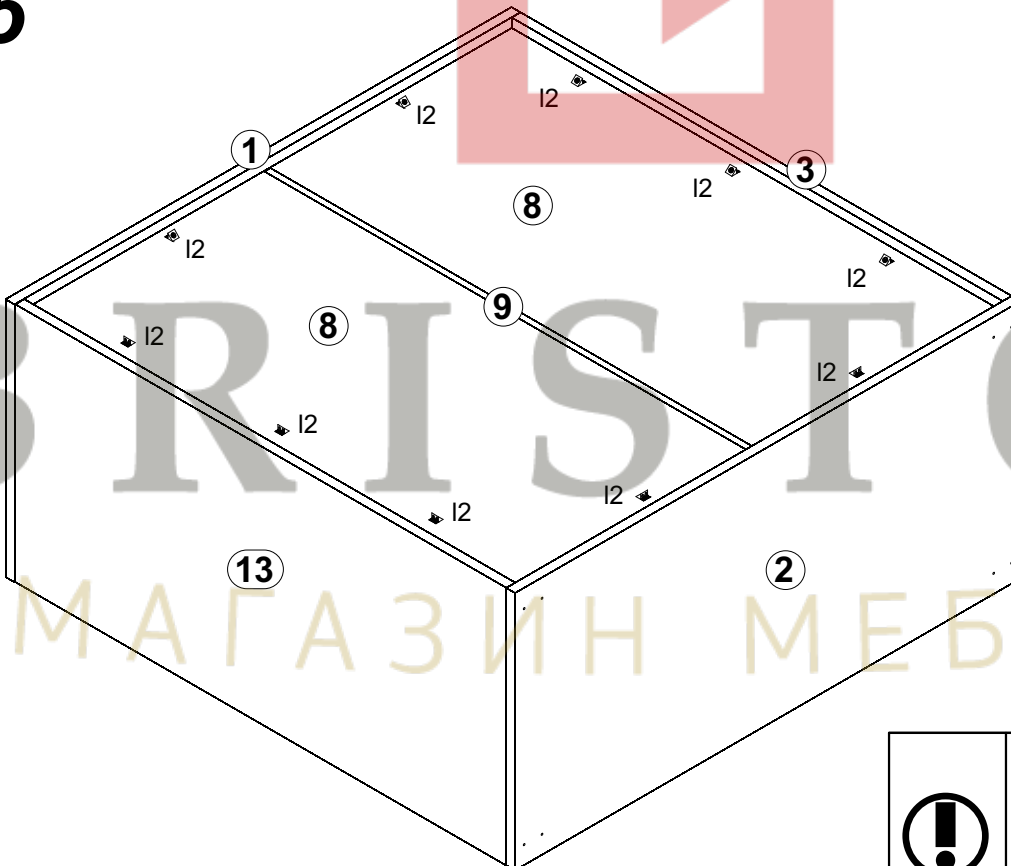

6

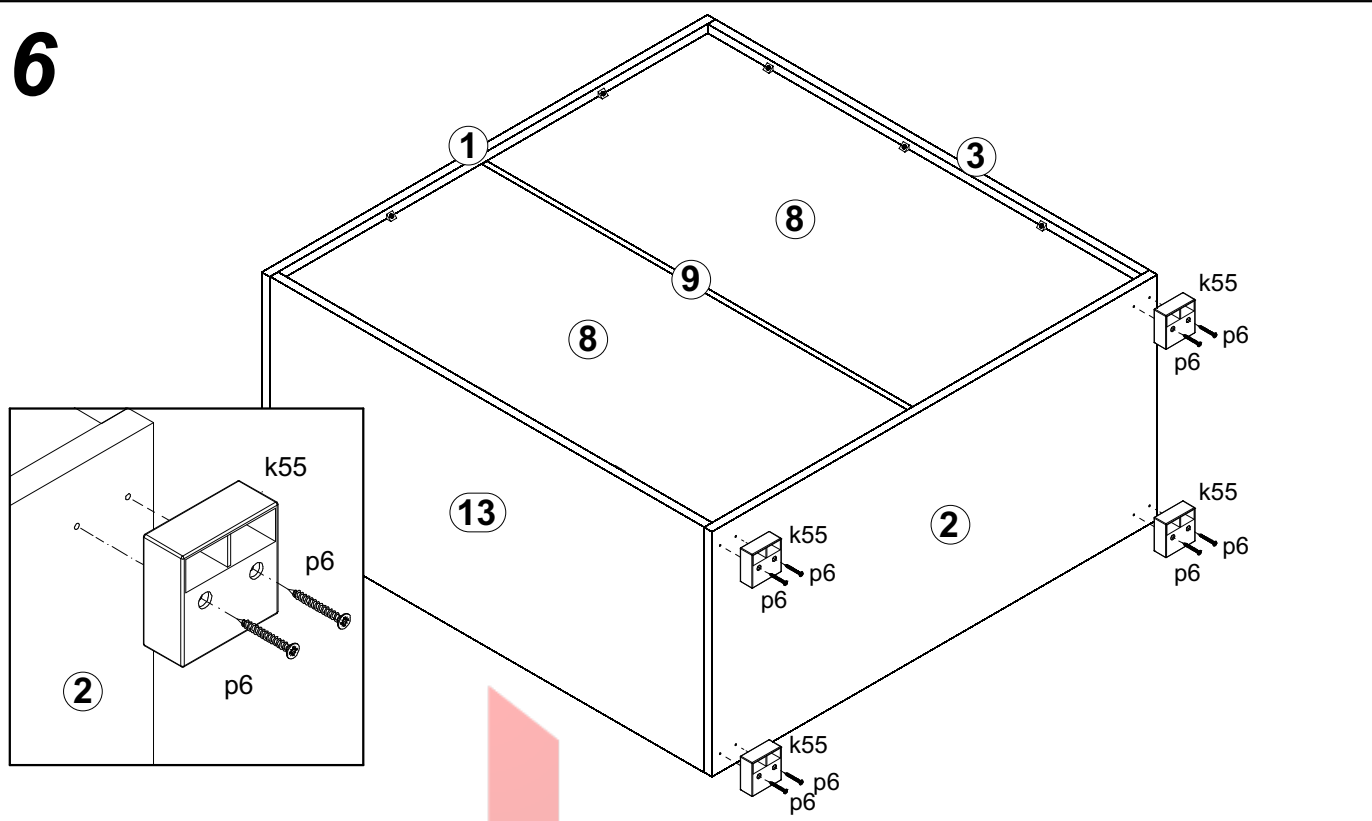

7

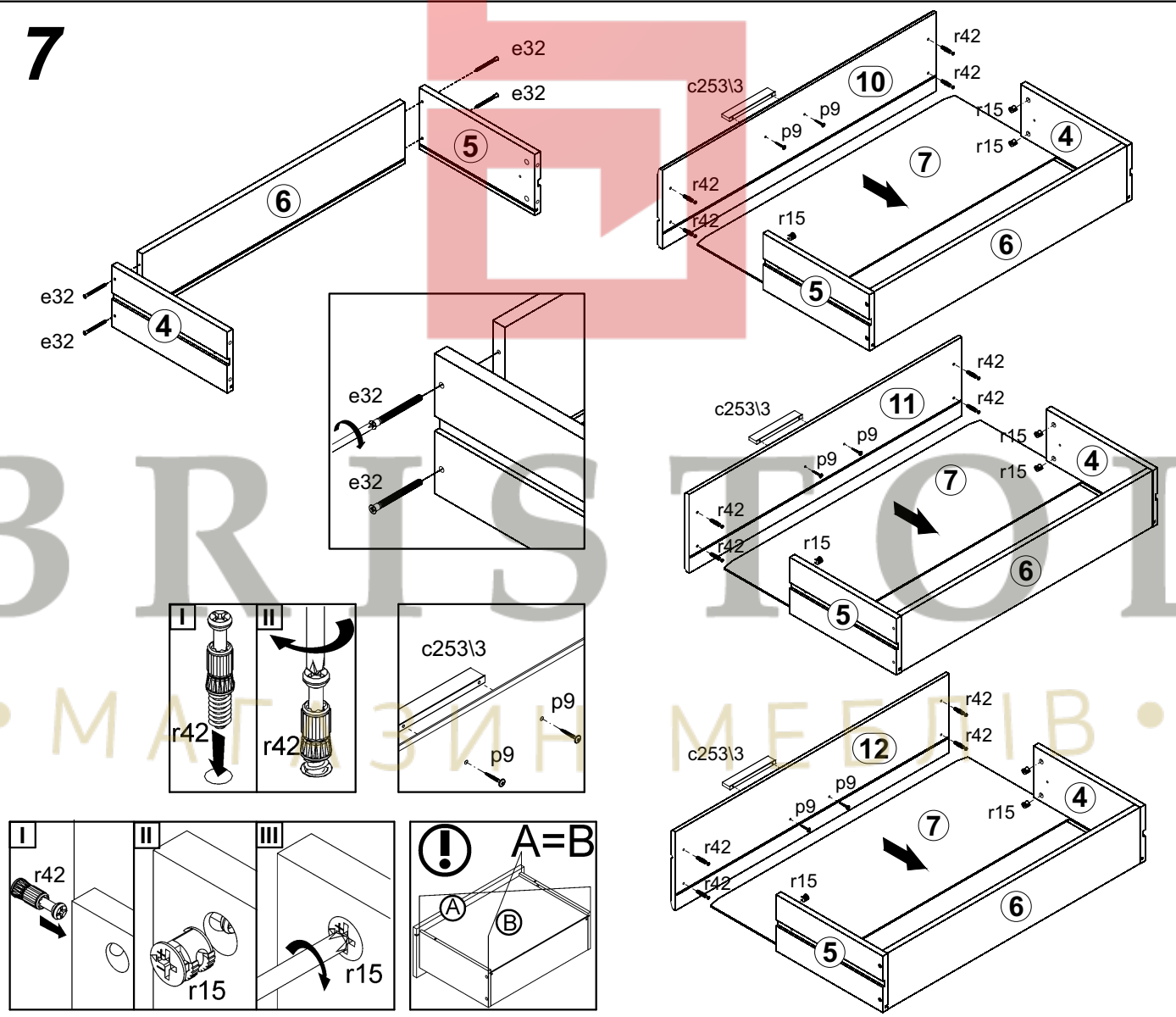

8

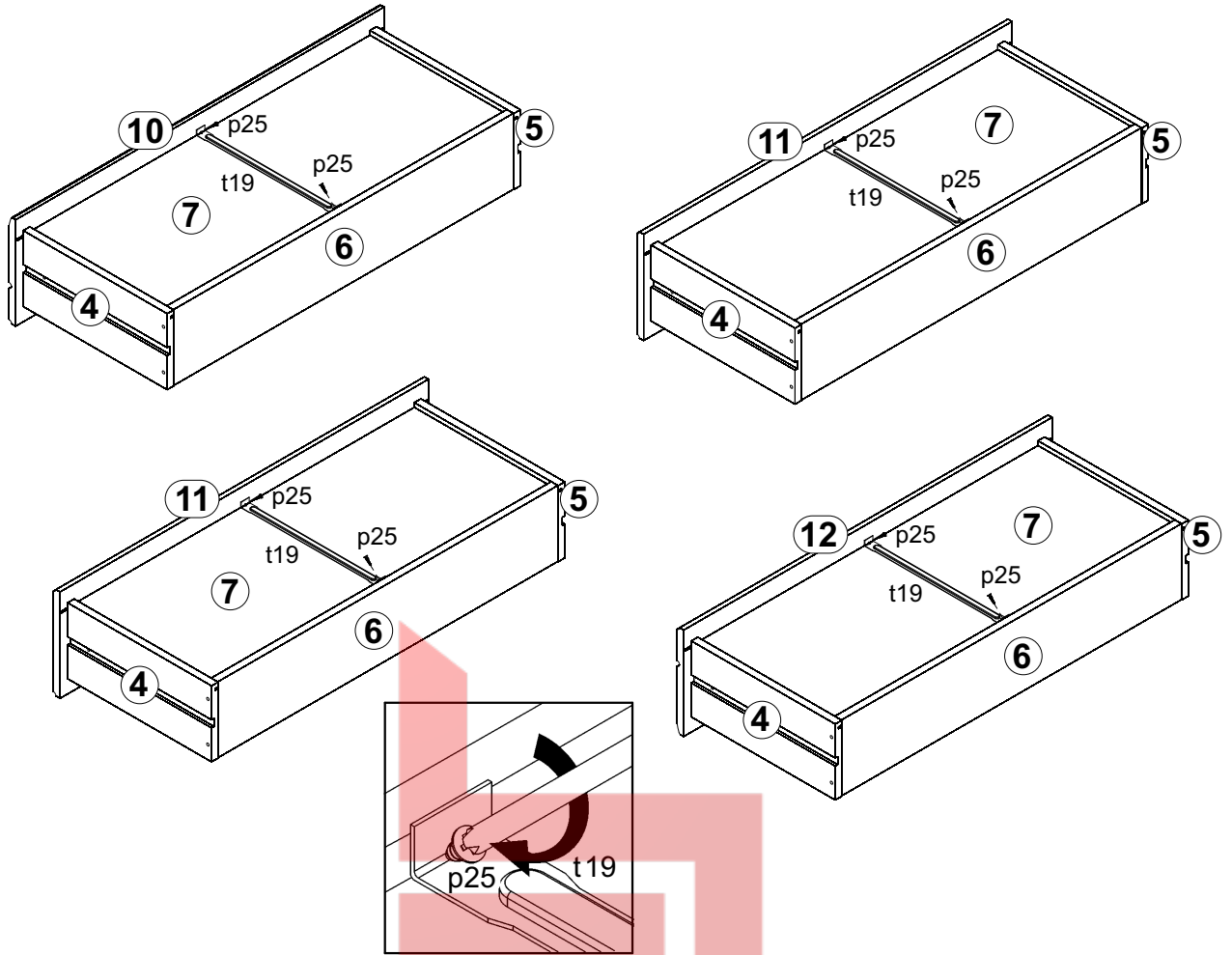

9

